

[54] MEAT MOLD OR SIMILAR ARTICLE

[75] Inventor: Stephen H. Wimmer, West Point, Nebr.

[73] Assignee: Wimmer's Meat Products, Inc., West Point, Nebr.

[\*\*] Term: 14 Years

[21] Appl. No.: 379,763

[22] Filed: May 19, 1982

[52] U.S. Cl. .... D7/43

[58] Field of Search ..... D7/43, 213, 412; 17/32; D1/3, 24, 26

[56] References Cited

U.S. PATENT DOCUMENTS

D. 119,783	4/1940	Hoy	.....	D7/43
D. 171,887	4/1954	Goldschmidt	.....	D7/43
D. 206,017	10/1966	Perry	.....	D7/43
1,094,878	4/1914	Cassell	.....	D7/43 X
2,597,592	5/1952	Minder	.....	17/32 X
3,290,721	12/1966	Siegal	.....	17/32

FOREIGN PATENT DOCUMENTS

527271	7/1956	Canada	.....	17/32 X
--------	--------	--------	-------	---------

Primary Examiner—Winifred E. Herrmann

Attorney, Agent, or Firm—Zarley, McKee, Thomte, Voorhees & Sease

[57] CLAIM

The ornamental design for a meat mold or similar article, substantially as shown and described.

DESCRIPTION

FIG. 1 is a top perspective view of a meat mold showing my new design;  
 FIG. 2 is a top plan view thereof;  
 FIG. 3 is a bottom plan view thereof;  
 FIG. 4 is a side elevational view thereof;  
 FIG. 5 is a left end elevational view thereof;  
 FIG. 6 is a right end elevational view thereof;  
 FIG. 7 is a top perspective view of a modification of my design of FIG. 1;  
 FIG. 8 is a top plan view of FIG. 7;  
 FIG. 9 is a bottom plan view of FIG. 7;  
 FIG. 10 is a side elevational view of FIG. 7;  
 FIG. 11 is a left end elevational view of FIG. 7;  
 FIG. 12 is a right end elevational view of FIG. 7;  
 FIG. 13 is a top perspective view of another modification of my design of FIG. 1;  
 FIG. 14 is a top plan view of FIG. 13;  
 FIG. 15 is a bottom plan view of FIG. 13;  
 FIG. 16 is a side elevational view of FIG. 13;  
 FIG. 17 is a left end elevational view of FIG. 13; and  
 FIG. 18 is a right end elevational view of FIG. 13.

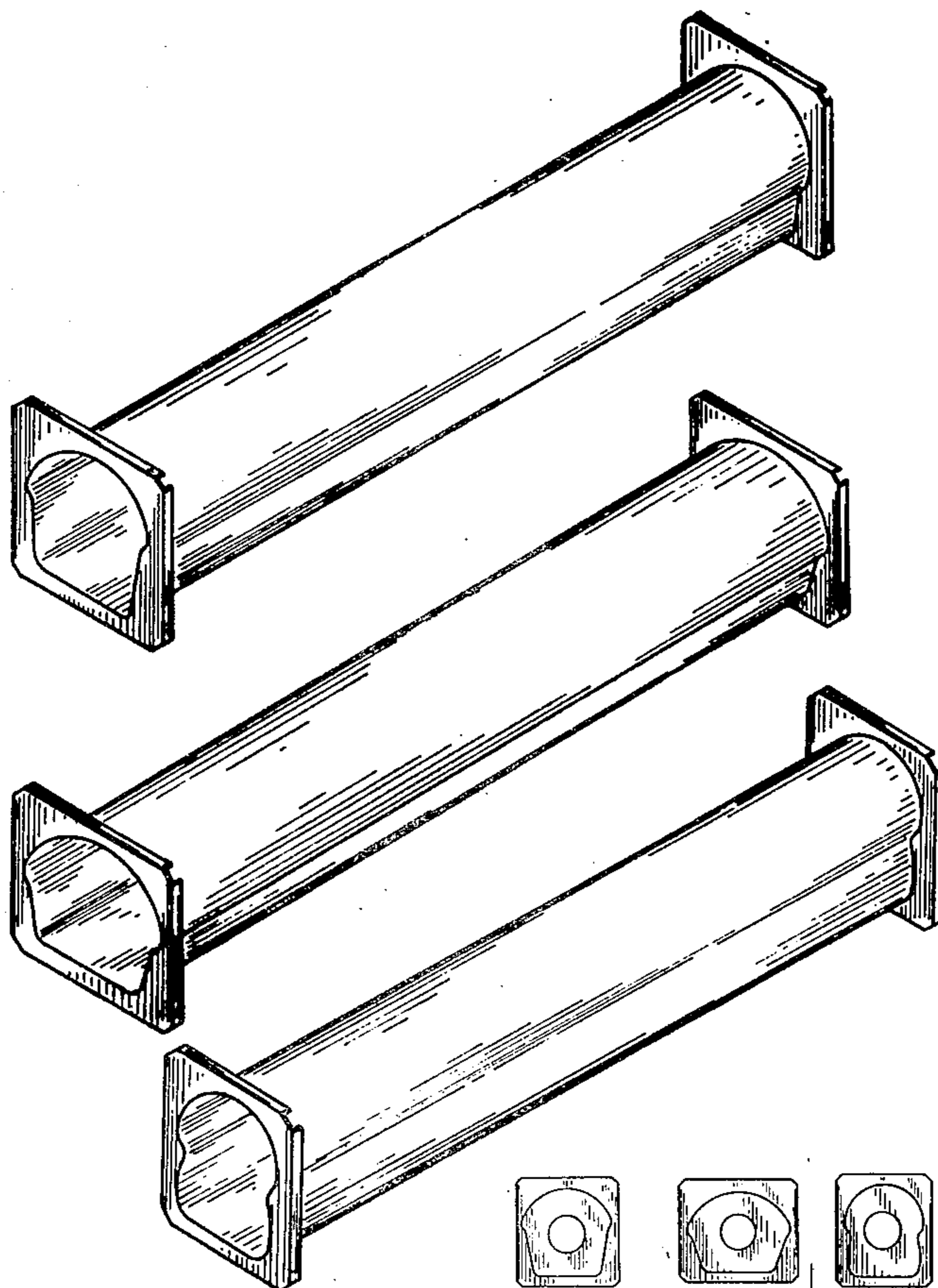

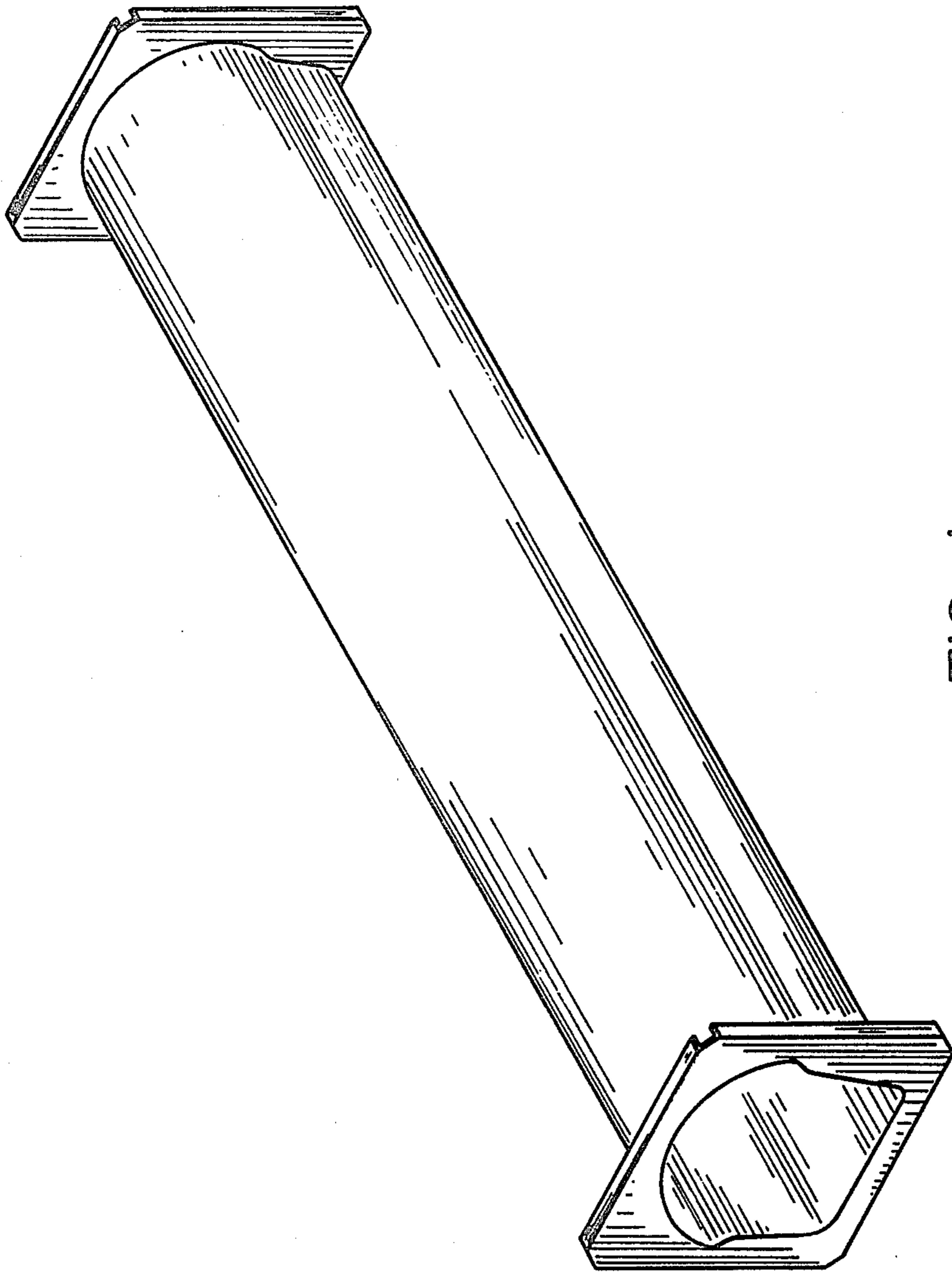

FIG. 1

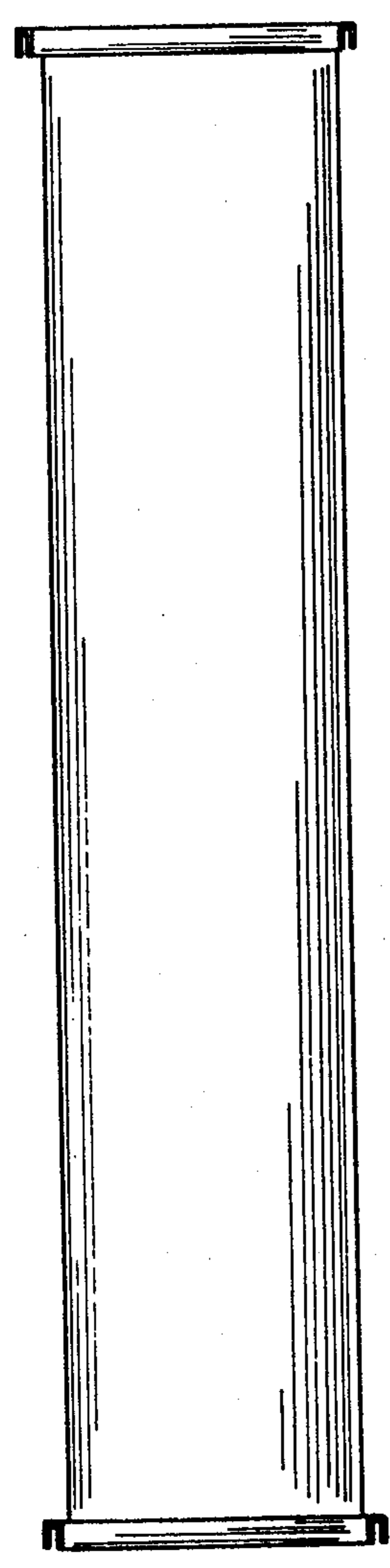

FIG. 2

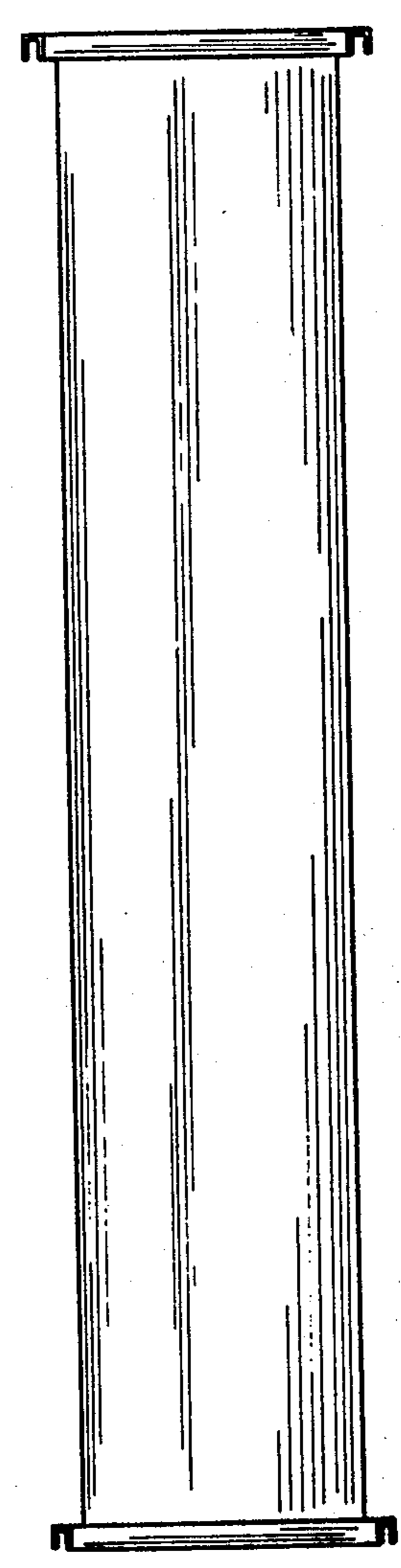

FIG. 4

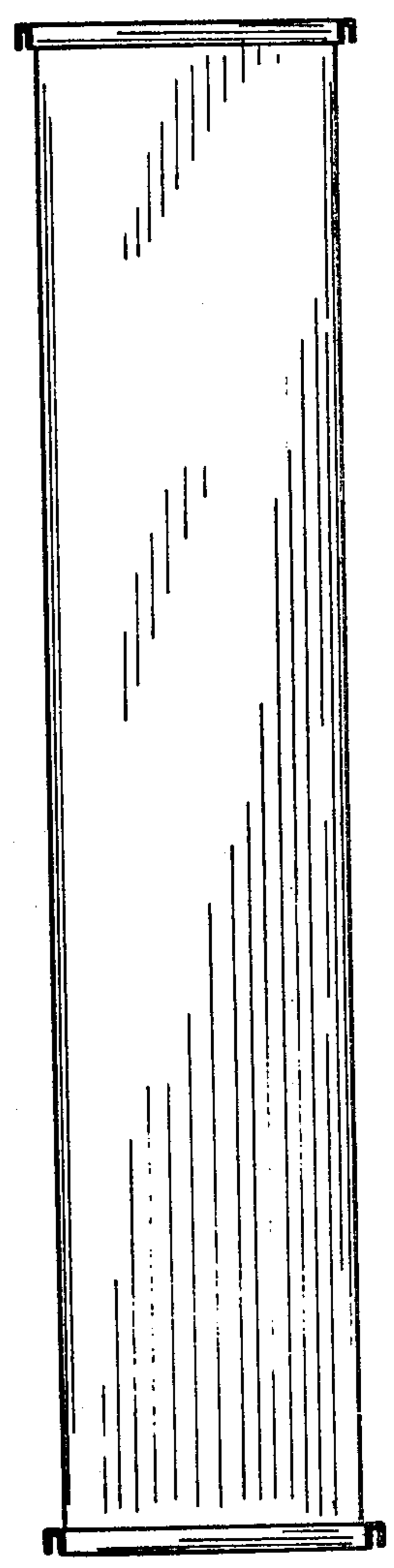

FIG. 3

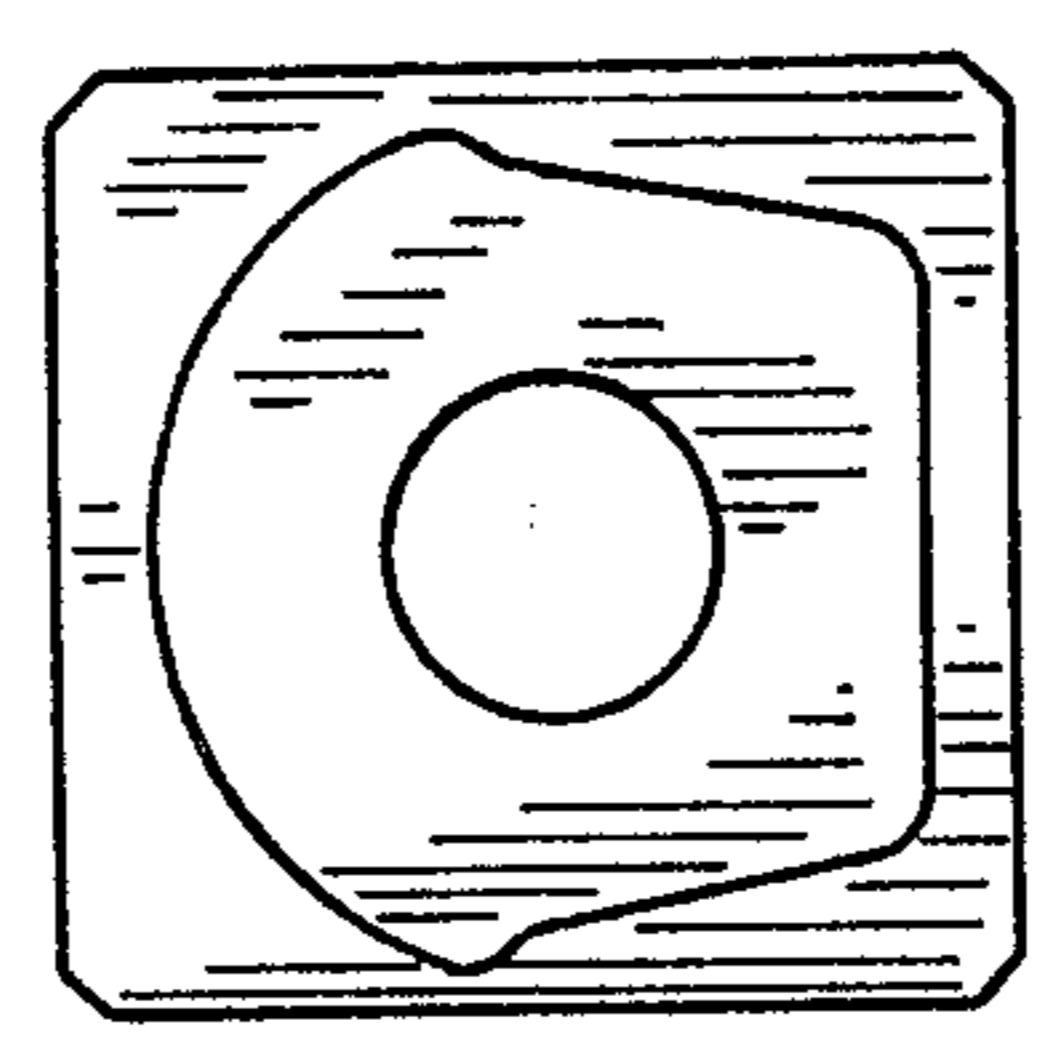

FIG. 5

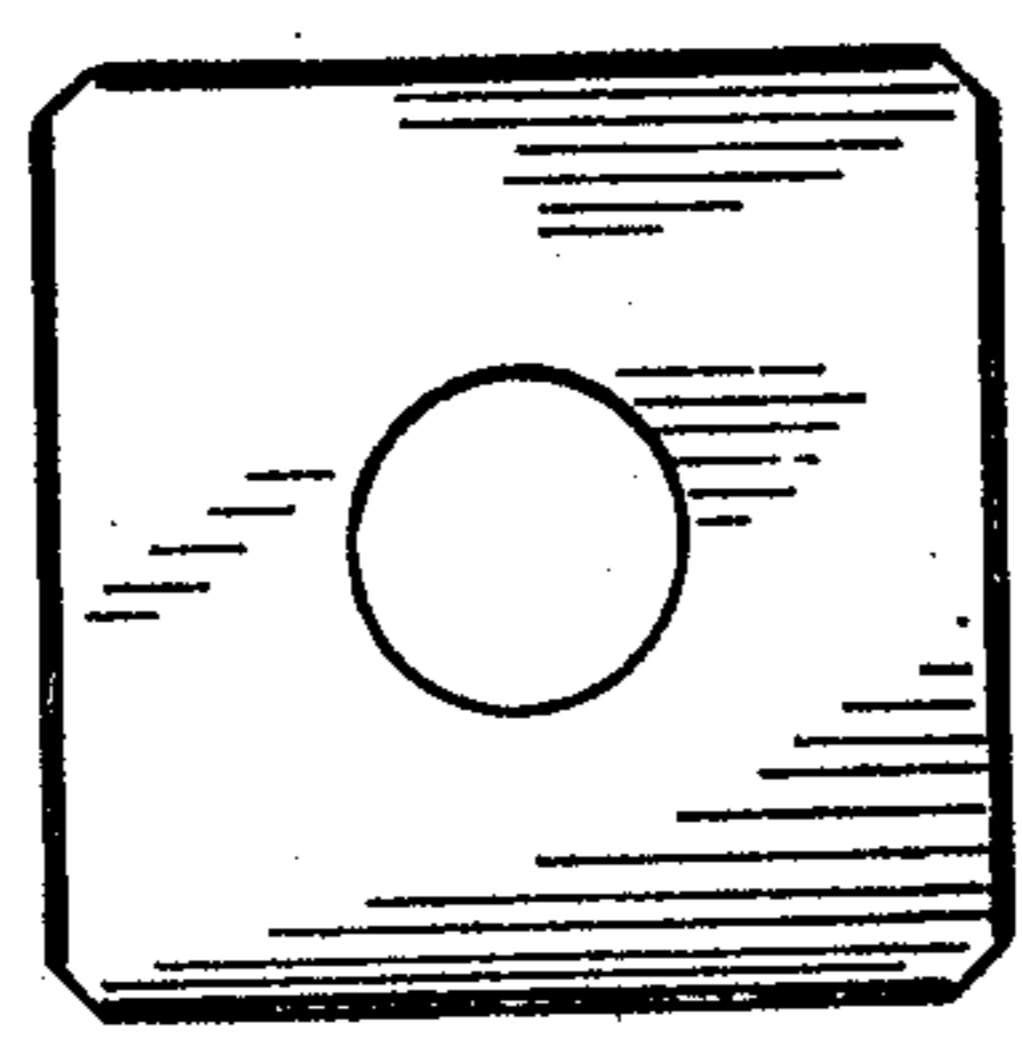

FIG. 6

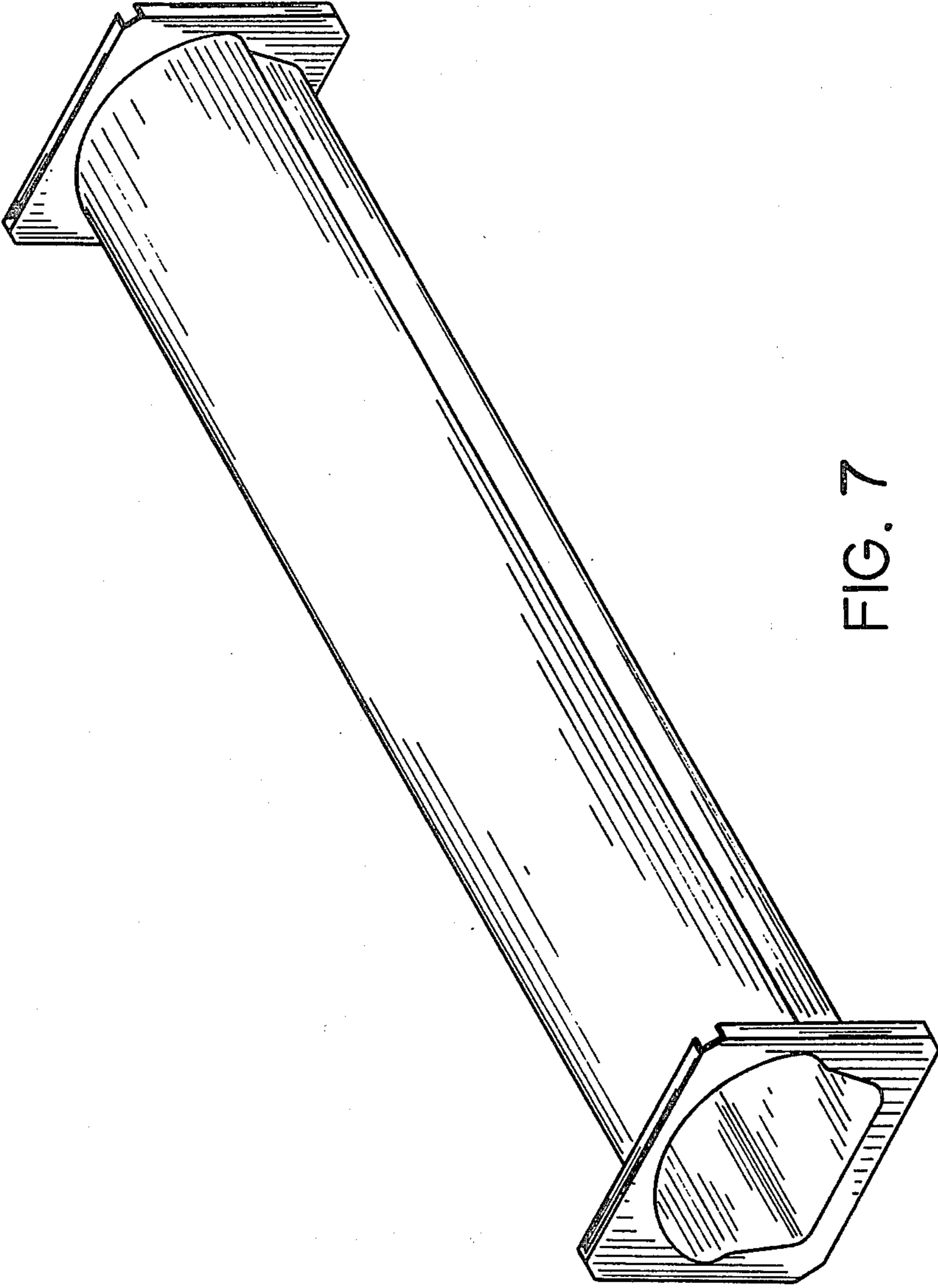

FIG. 7

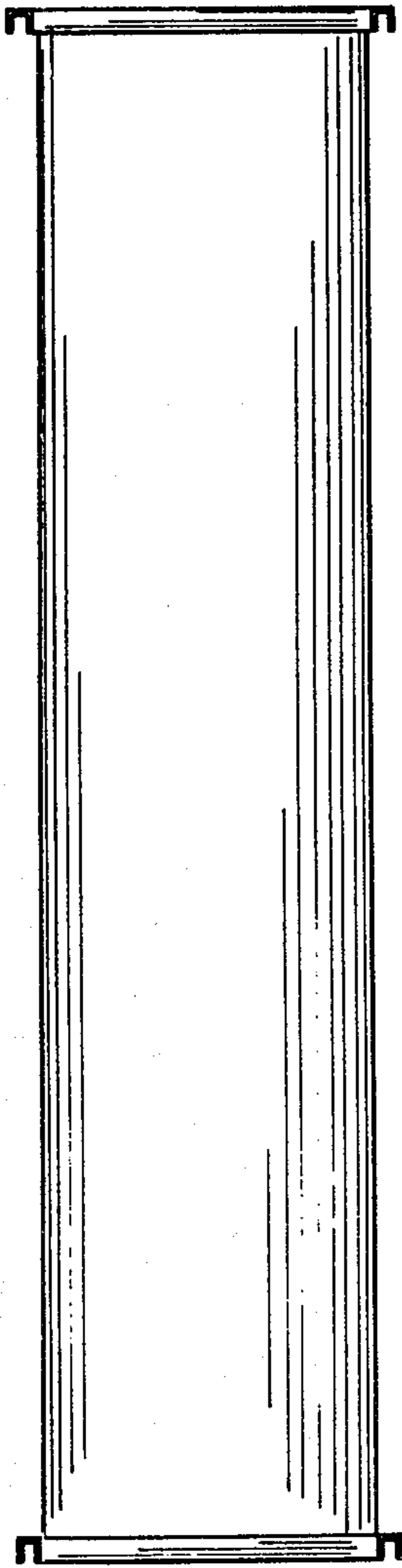

FIG. 8

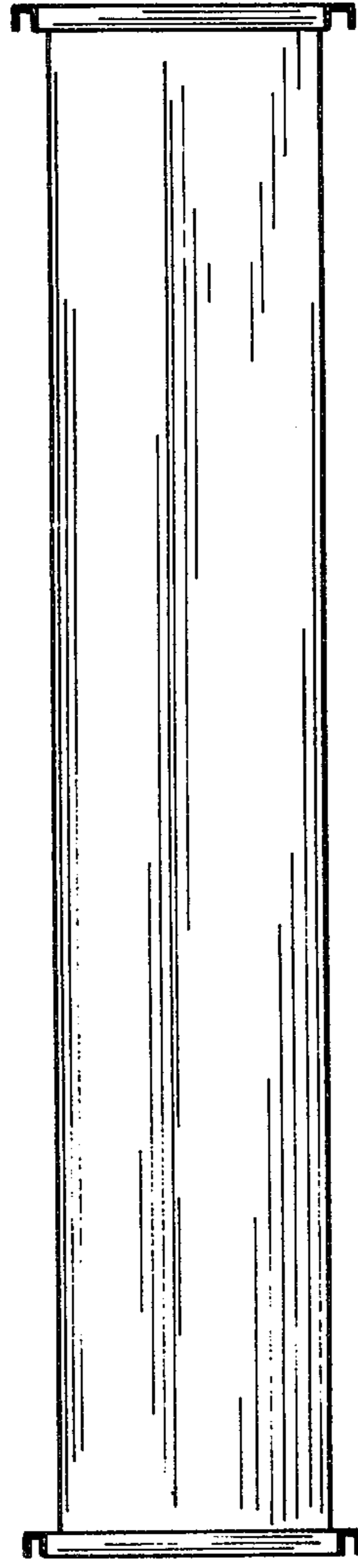

FIG. 10

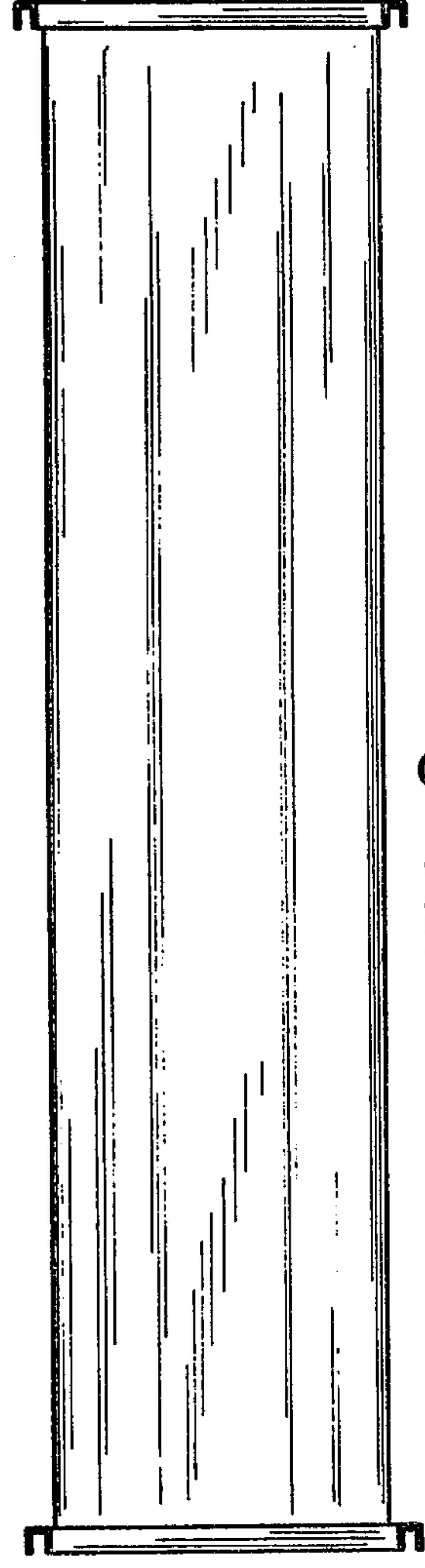

FIG. 9

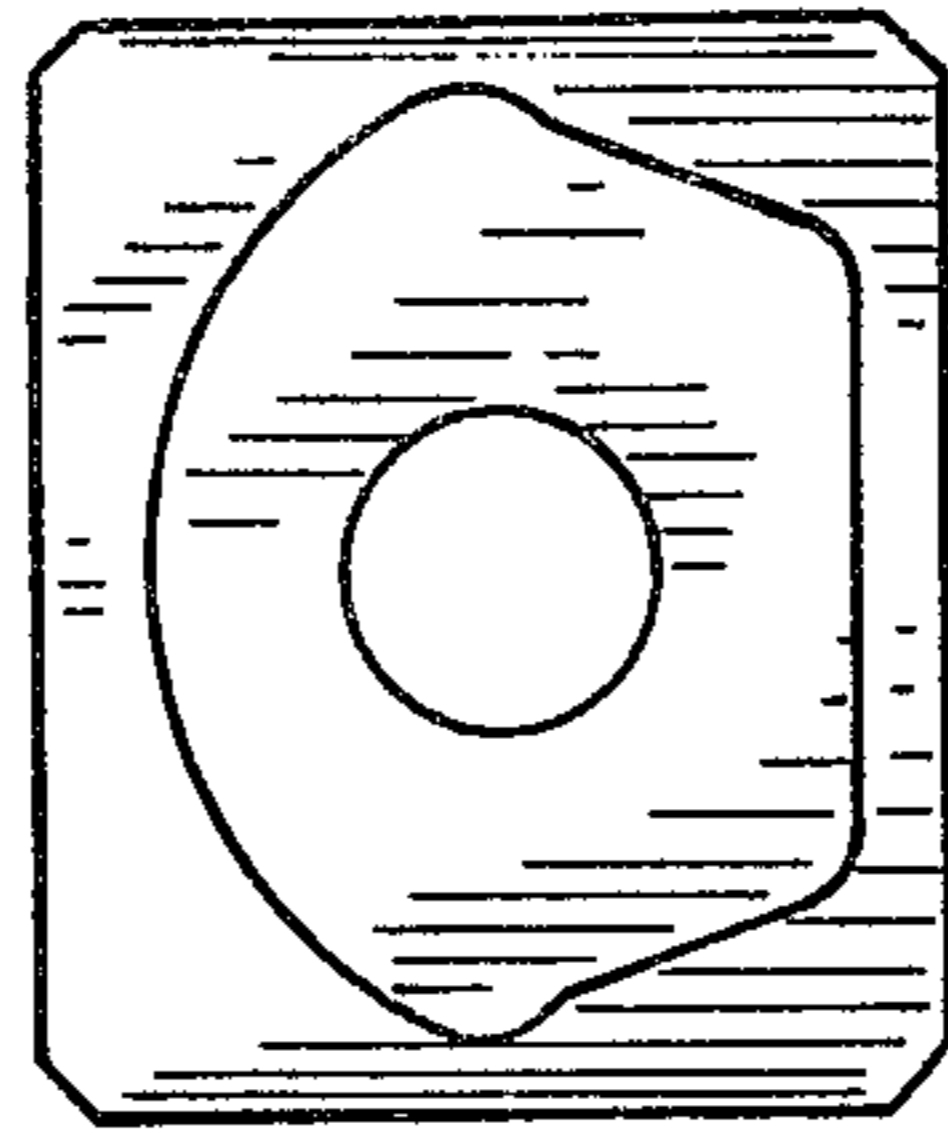

FIG. 11

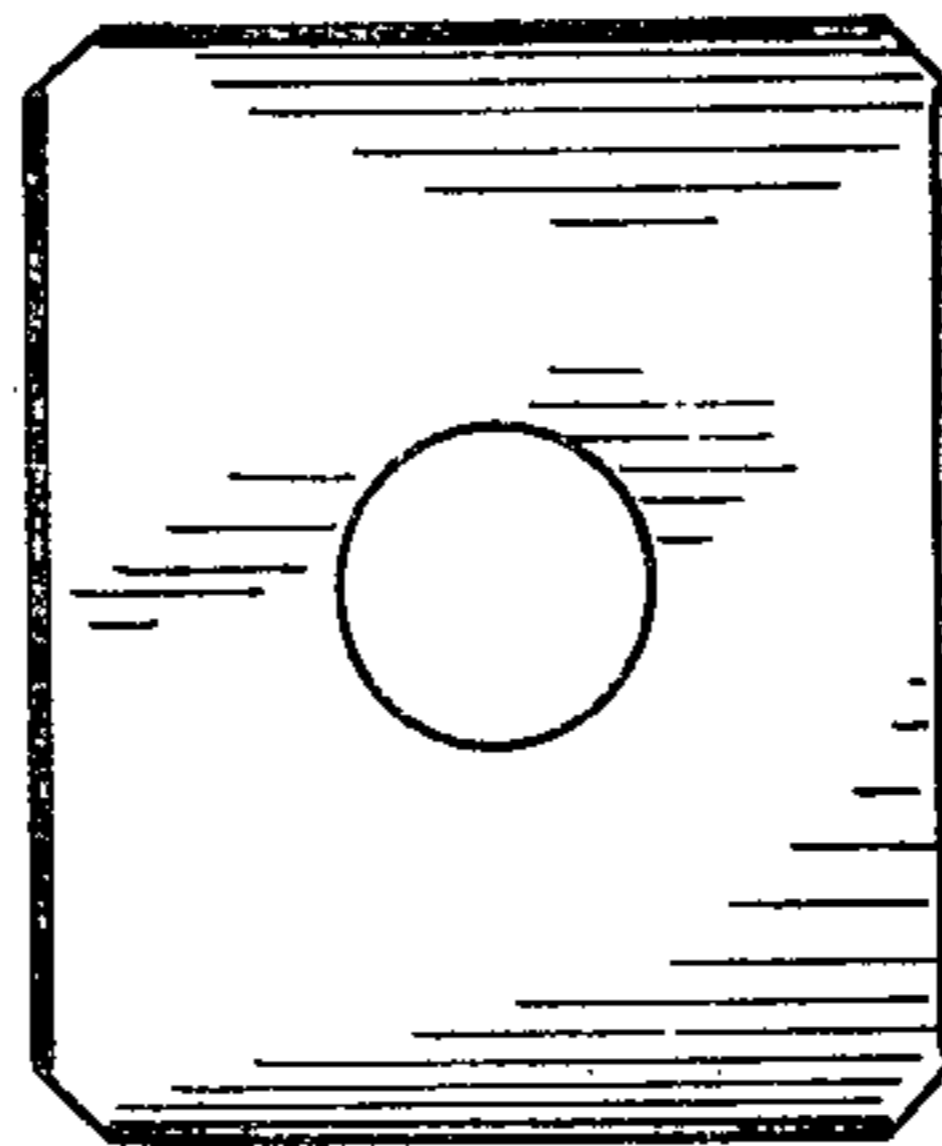

FIG. 12

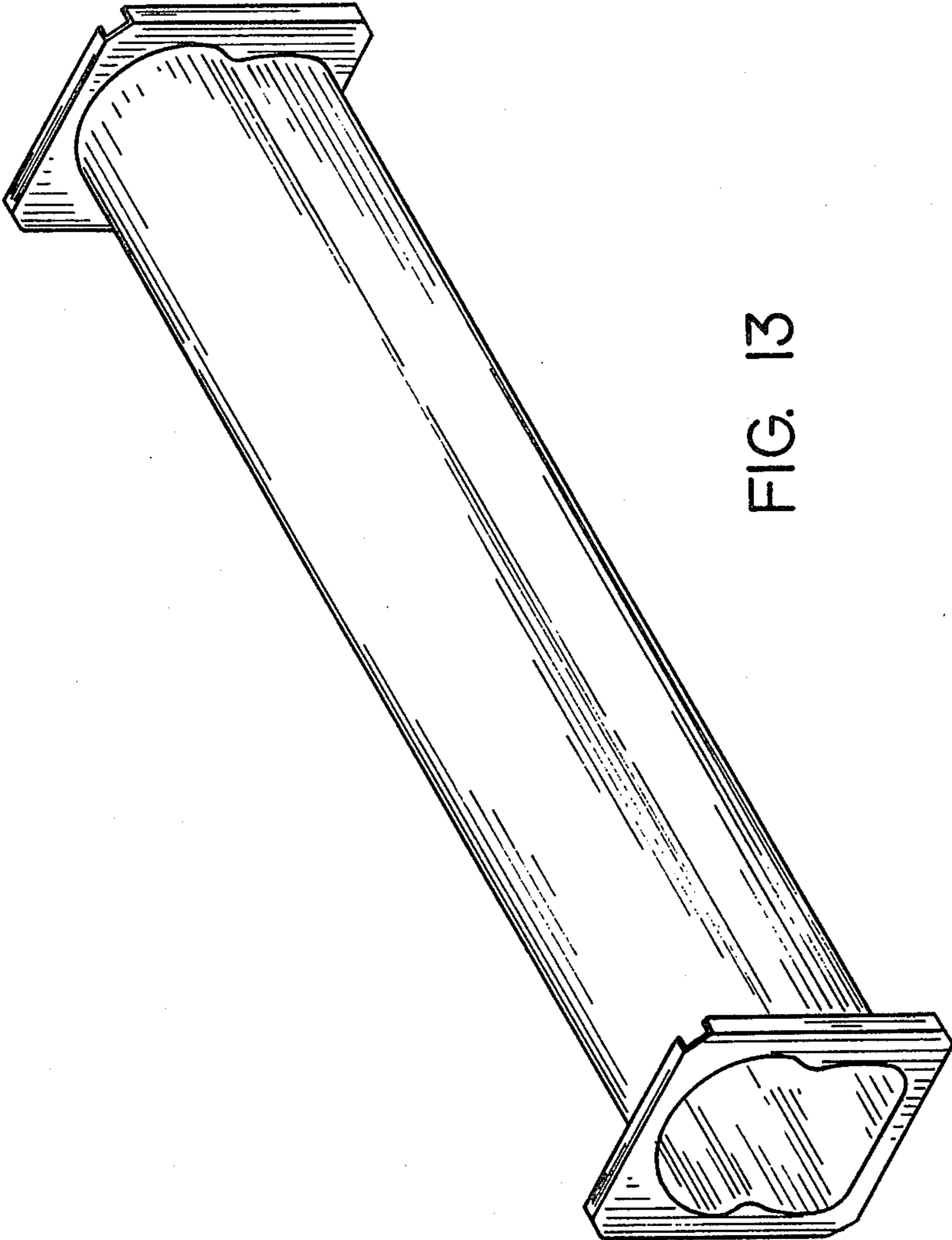

FIG. 13

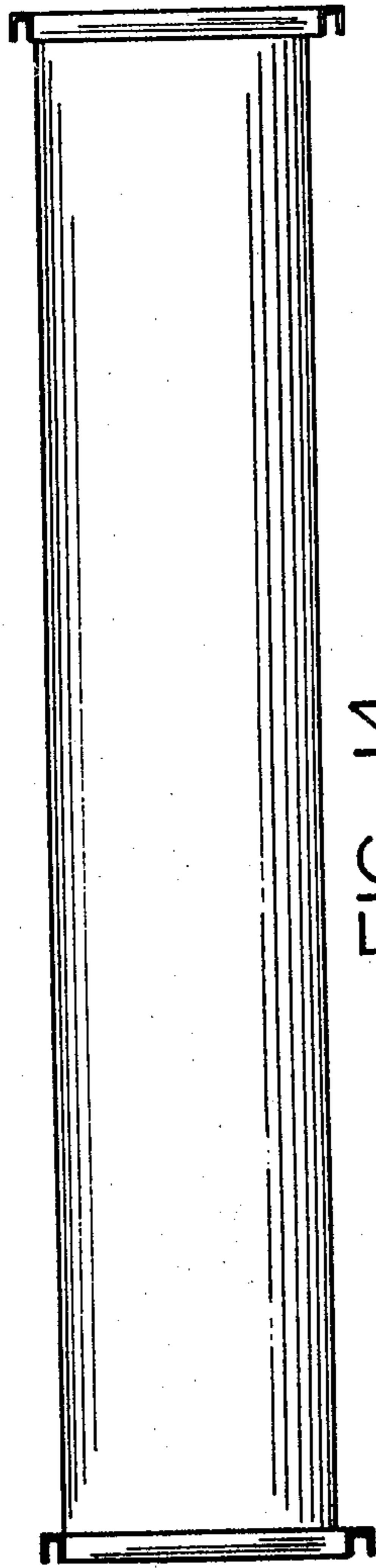

FIG. 14

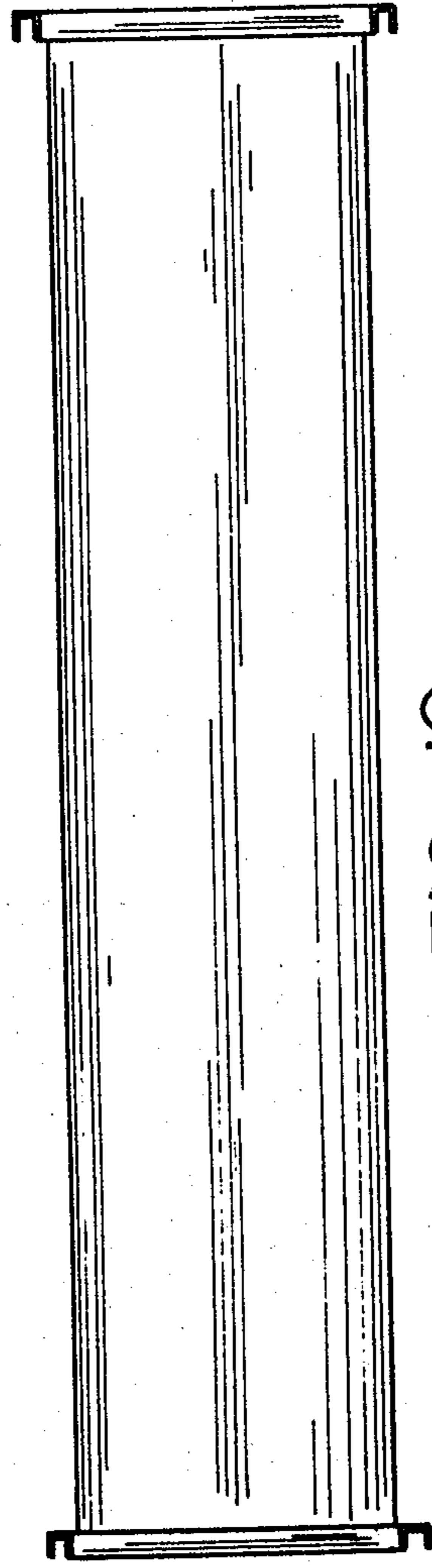

FIG. 16

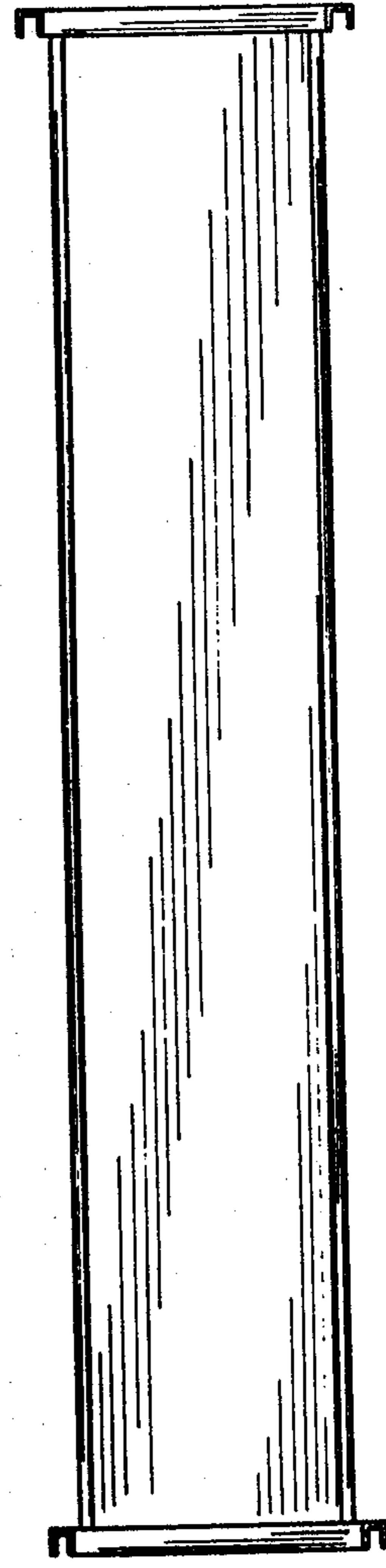

FIG. 15

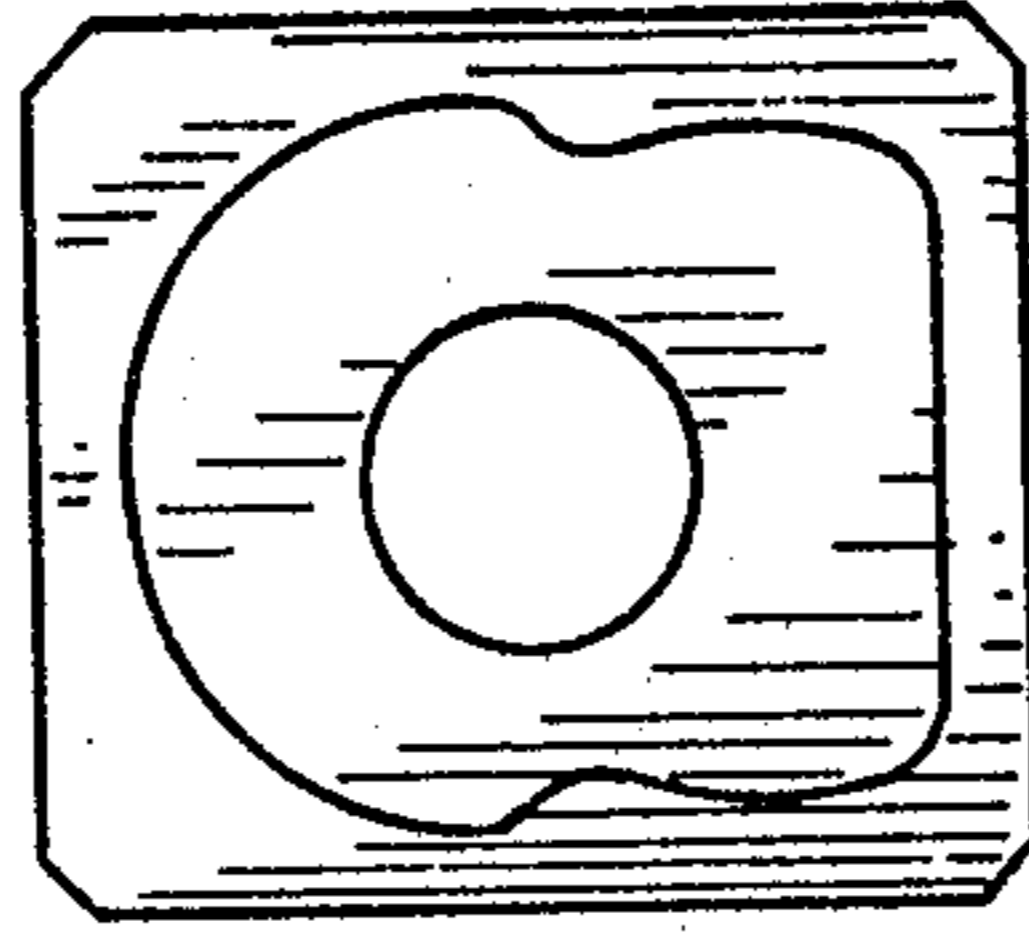

FIG. 17

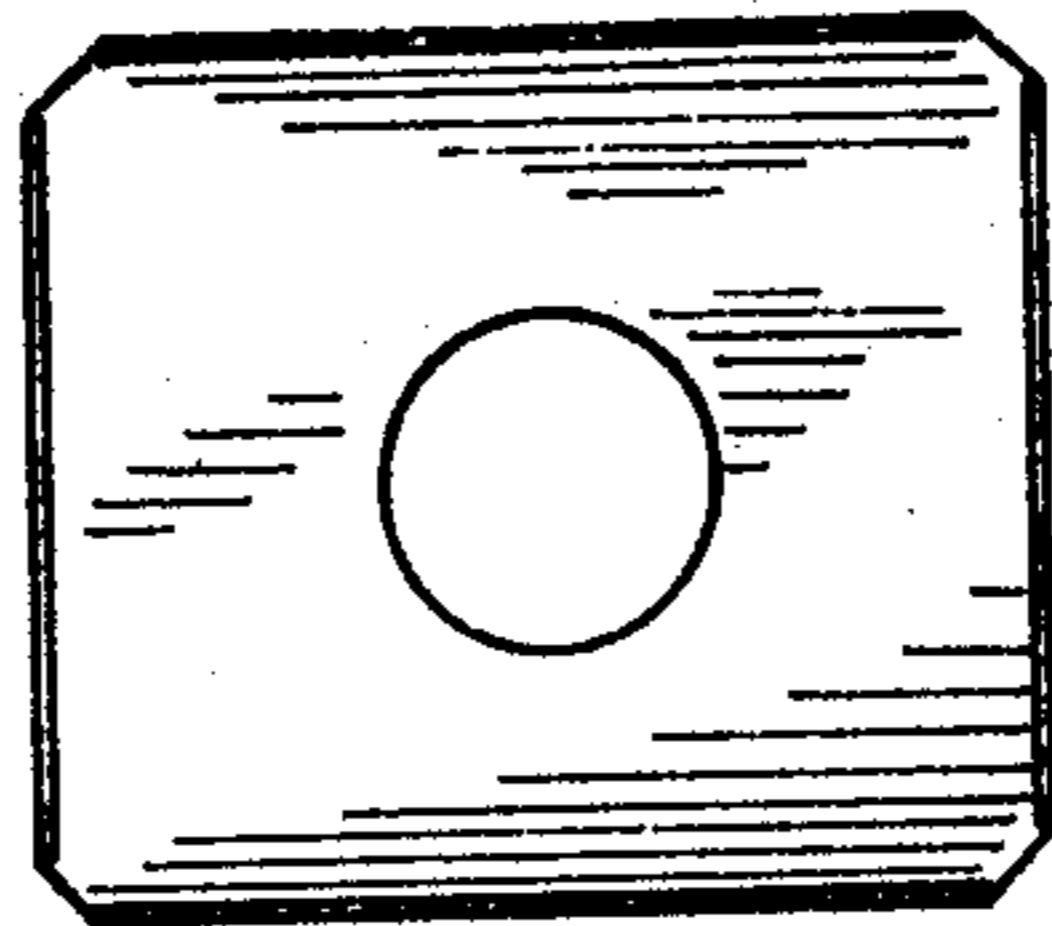

FIG. 18