

[54] TELEVISION PROJECTOR

[75] Inventor: Masayoshi Tsuchiya, Tokyo, Japan

[73] Assignee: Sony Corporation, Tokyo, Japan

[**] Term: Years

[21] Appl. No.: 373,130

[22] Filed: Apr. 29, 1982

[30] Foreign Application Priority Data

Oct. 30, 1981 [JP] Japan 56-048429

[52] U.S. Cl. D14/79; D14/77; D14/83

[58] Field of Search D14/77, 79-84; 312/7.2

[56] References Cited

U.S. PATENT DOCUMENTS

247,176	6/1976	Girson et al. .	
262,704	8/1979	Pierog .	
D. 265,090	6/1982	Coban	D14/83 X
D. 267,875	2/1983	Mitchell et al.	D14/82 X
D. 271,200	11/1983	Kawasaki et al.	D14/83 X
3,943,282	6/1975	Muntz .	
4,209,807	6/1980	Arita	D14/83

OTHER PUBLICATIONS

Retailing Home Furnishings, 3-1-82, Video Advertising Supplement, Sony KP-5040 Ad.

Design patent to Inoue et al. set forth in Jul. 1, 1980 Official Gazette Widworld Entertainment Systems, Inc. copyright 1976.

Advertising brochure for Sony Projection System and Projection TV.

Advertising brochure of Sony Corporation entitled "What's Better Than a Box Seat."

Page 39, of Japanese Official Gazette first sheet of patent 50-68617 filed 1973, pp. 27-31 of the April 1980 Video Play.

Primary Examiner—Jane E. Corrigan

Attorney, Agent, or Firm—Lewis H. Eslinger; Alvin Somderbrand

[57] CLAIM

The ornamental design for a television projector, as shown and described.

DESCRIPTION

FIG. 1 is a perspective view of the television projector embodying my design;

FIG. 2 is a top view;

FIG. 3 is a front view;

FIG. 4 is a left side view;

FIG. 5 is a right side view;

FIG. 6 is a rear view;

FIG. 7 is a bottom view; and

FIG. 8 is a perspective view in the shut position.

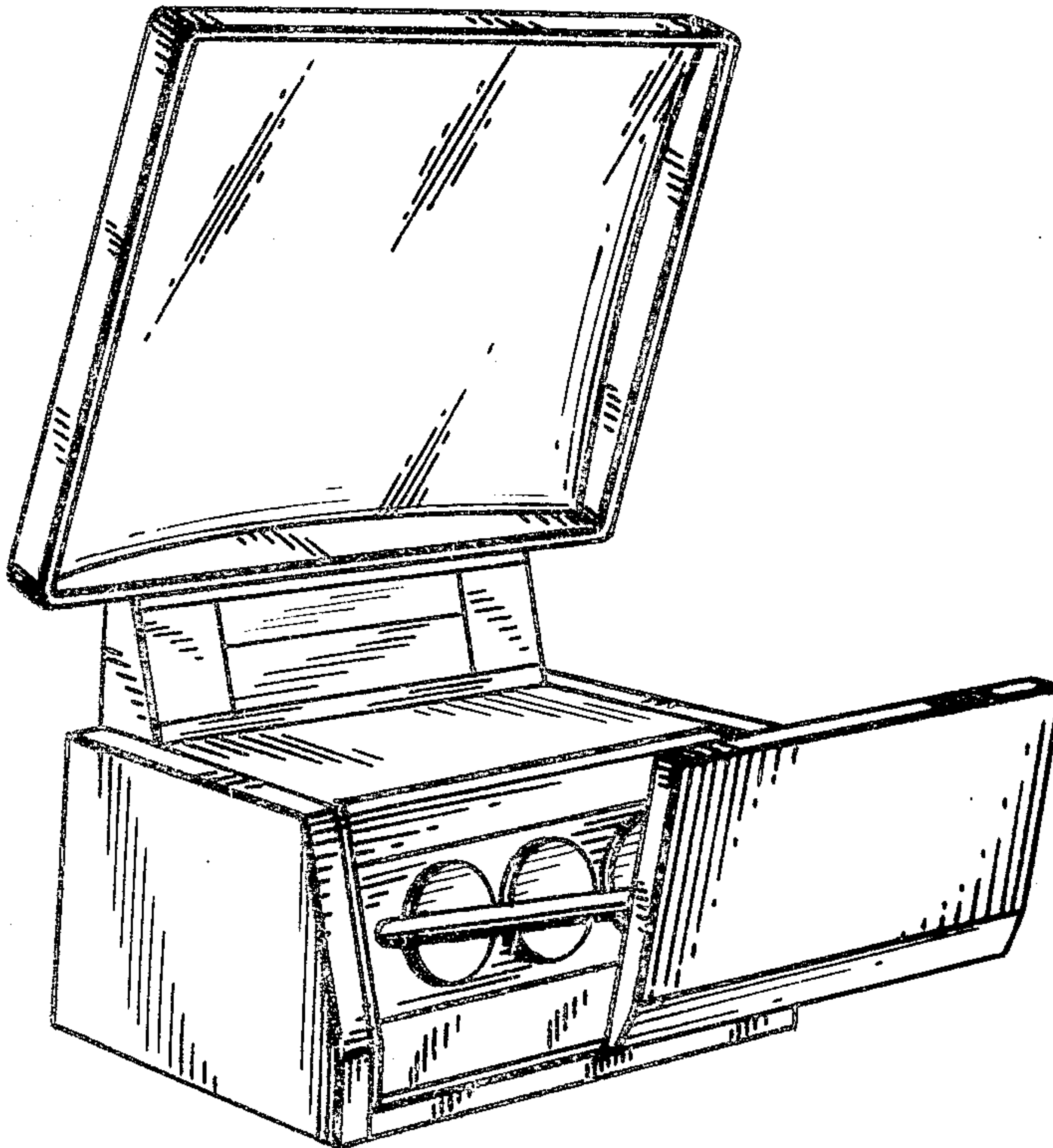

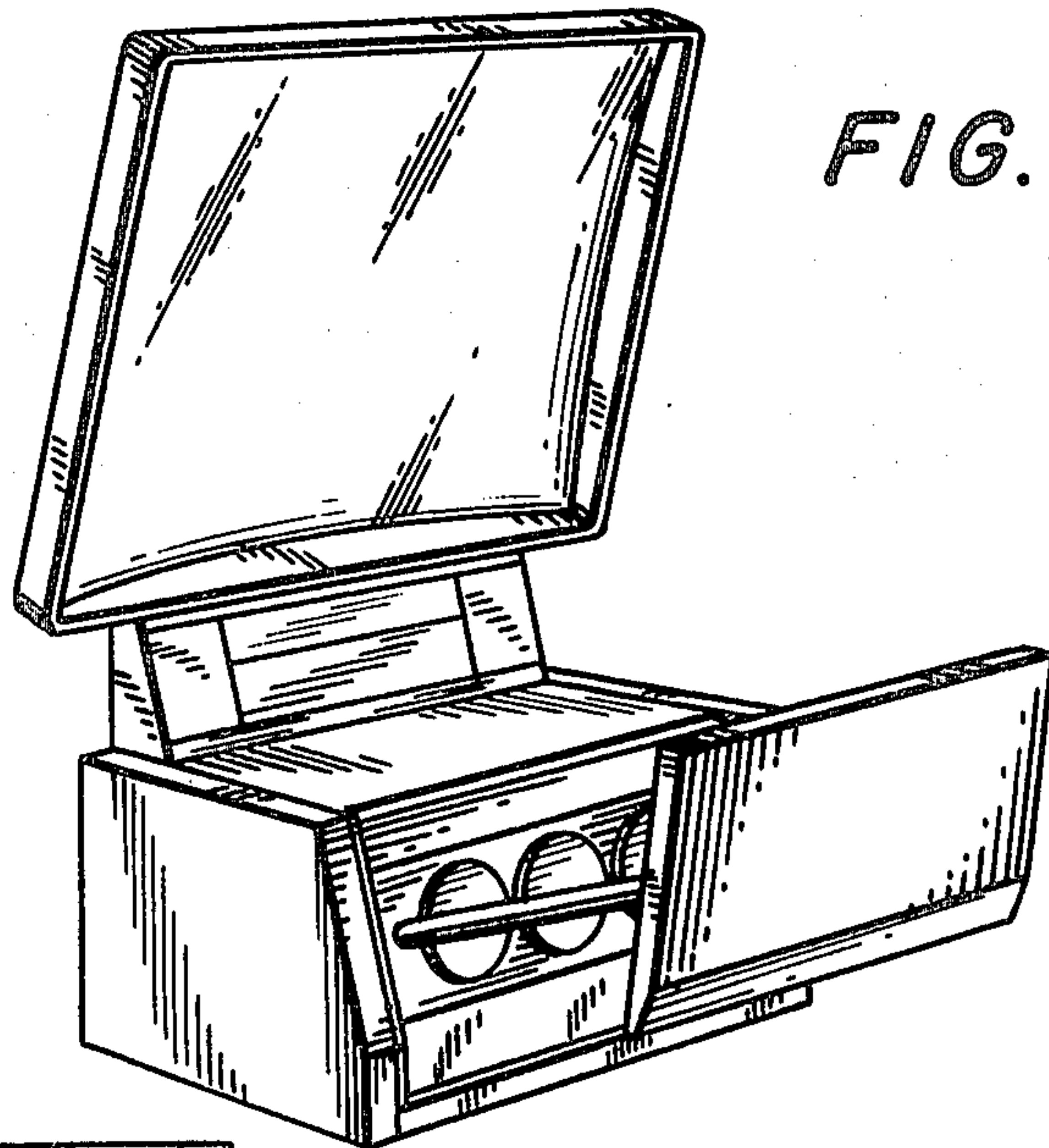

FIG. 1

FIG. 2

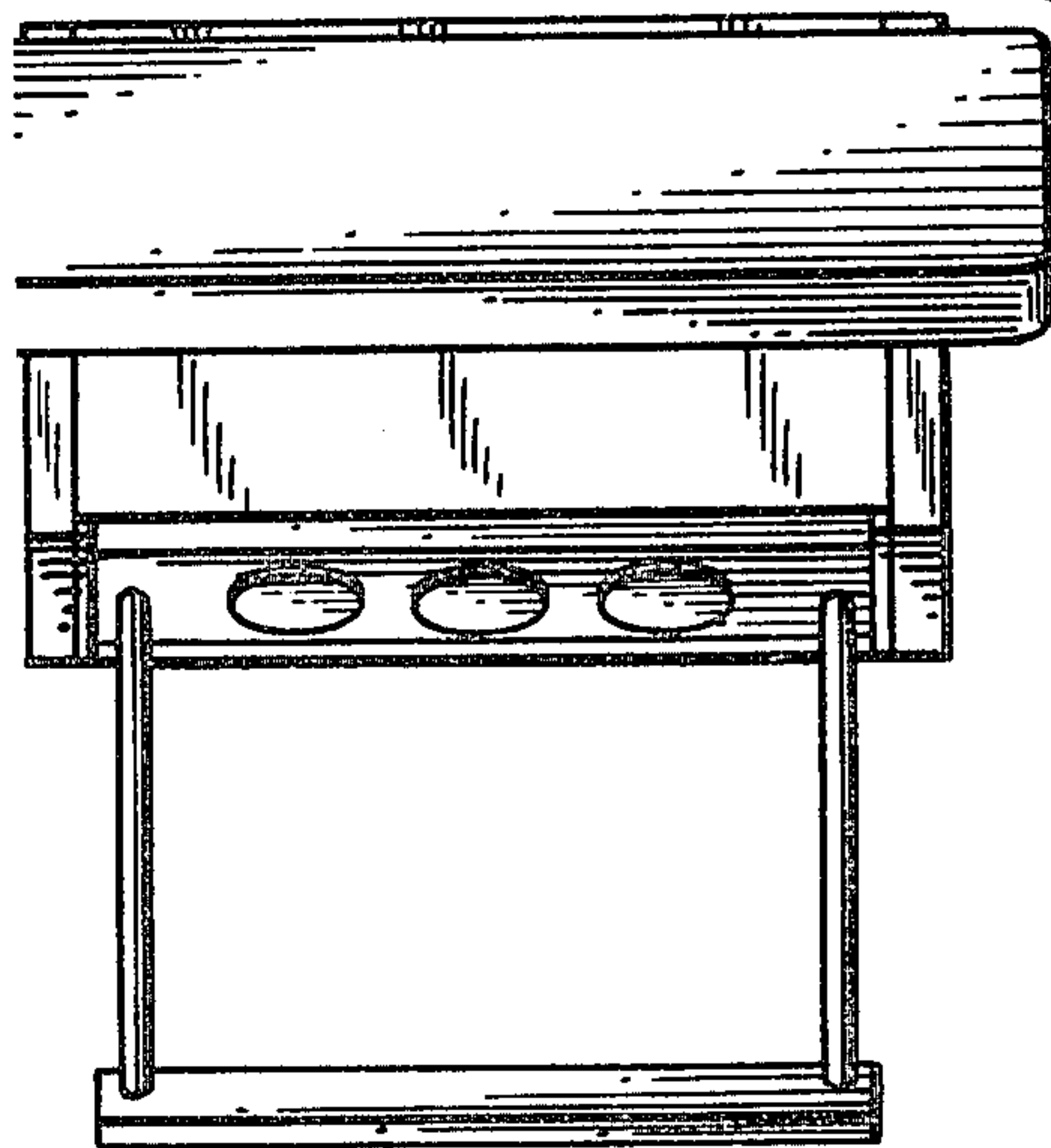

FIG. 3

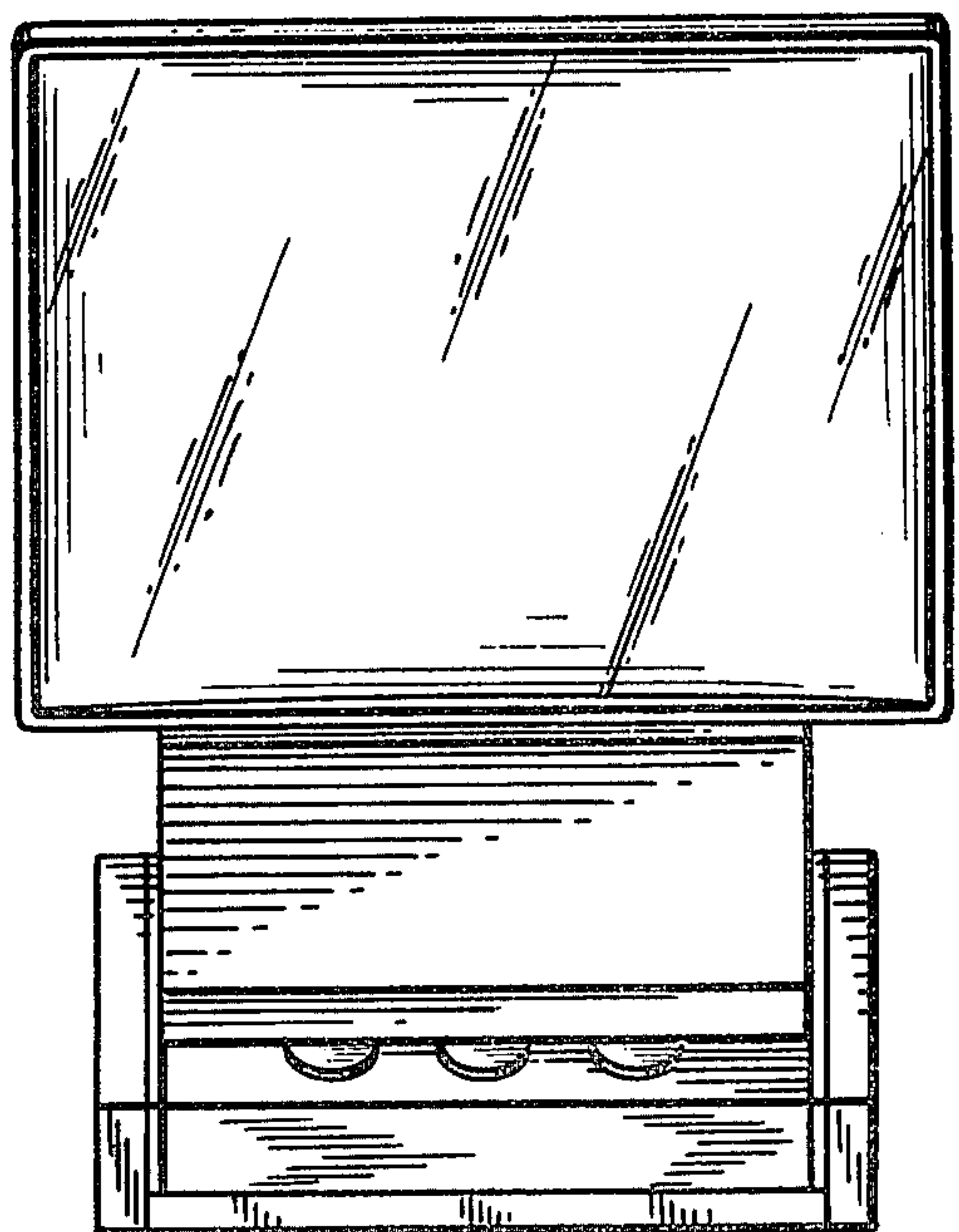
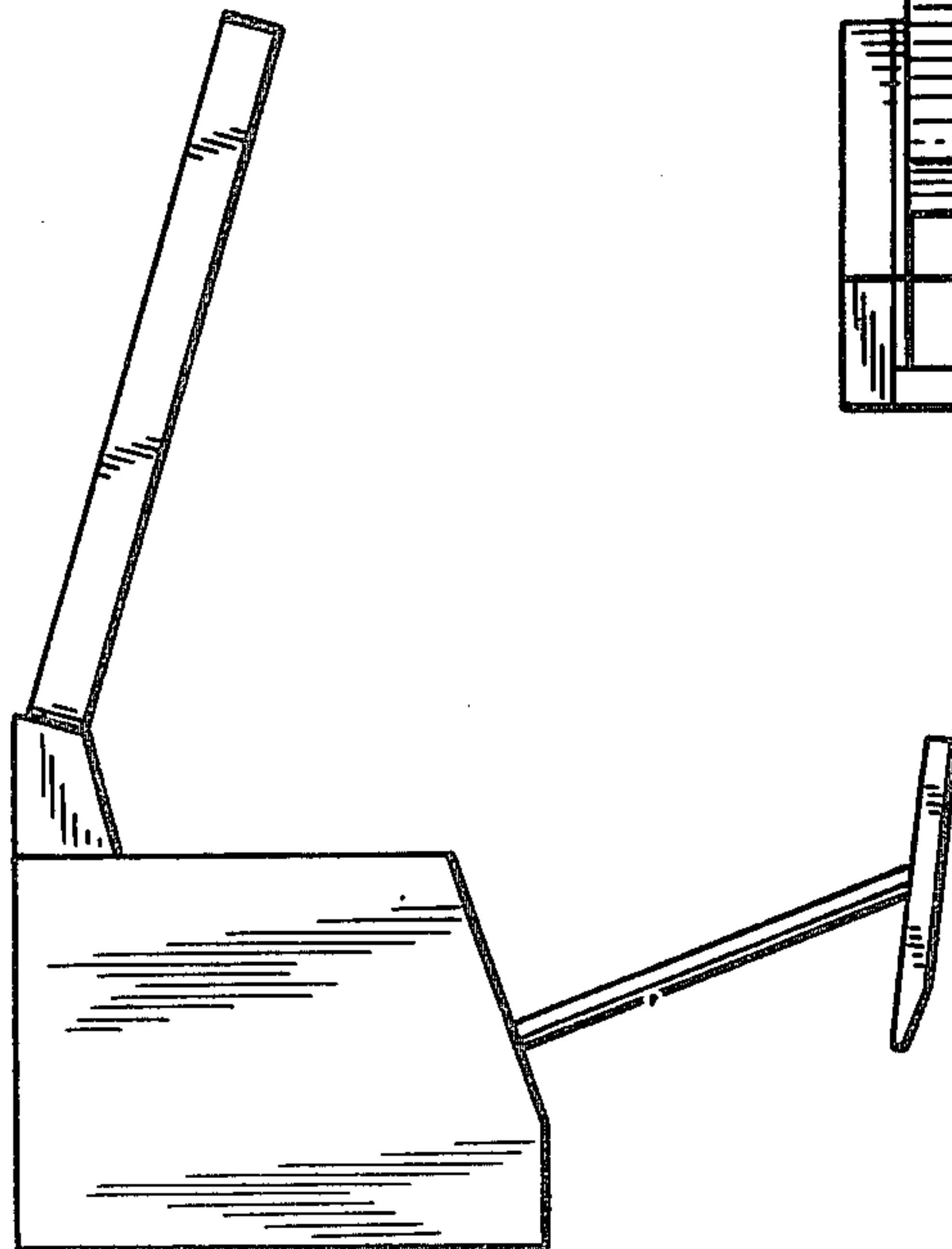

FIG. 4



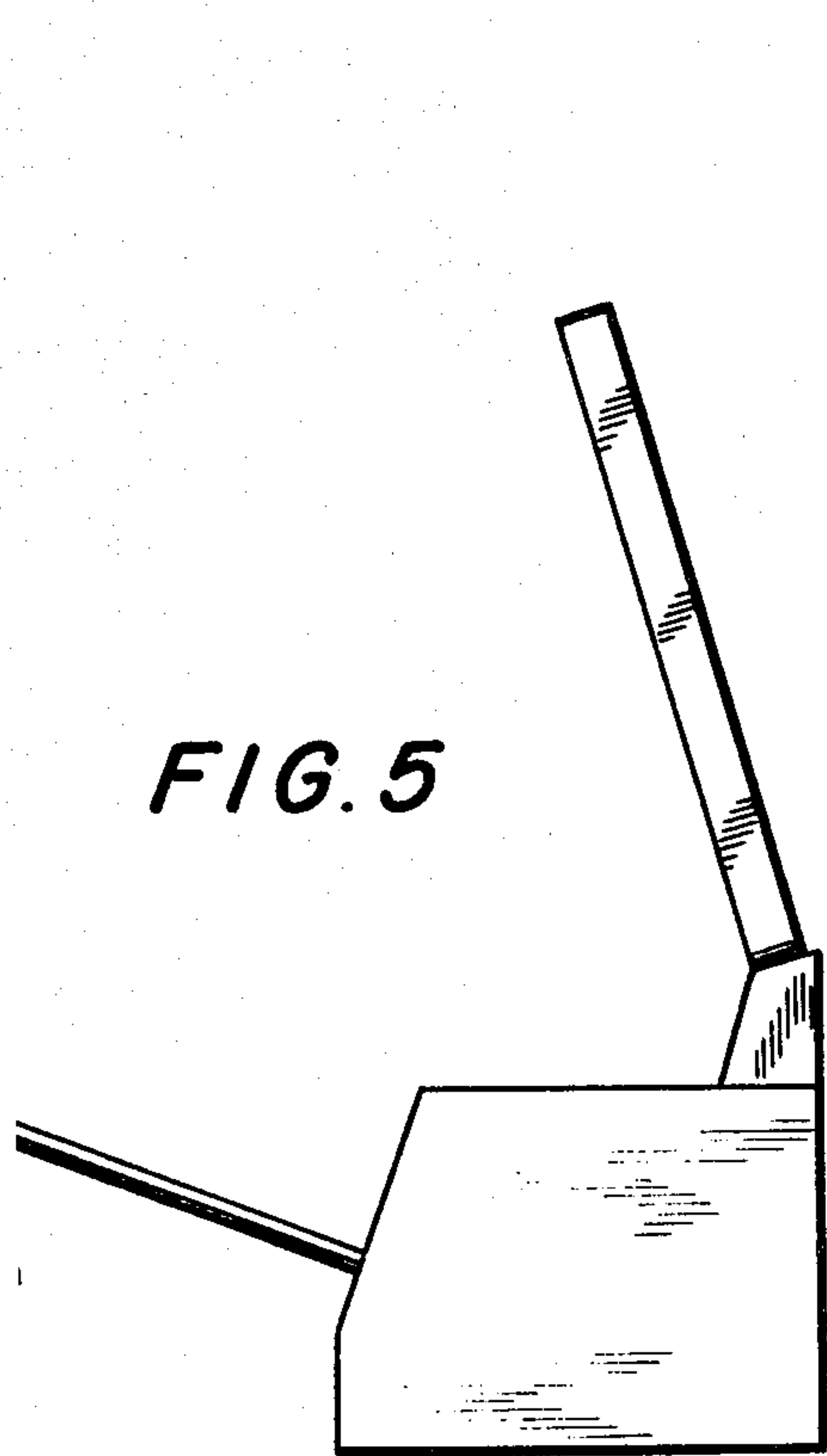

FIG. 6

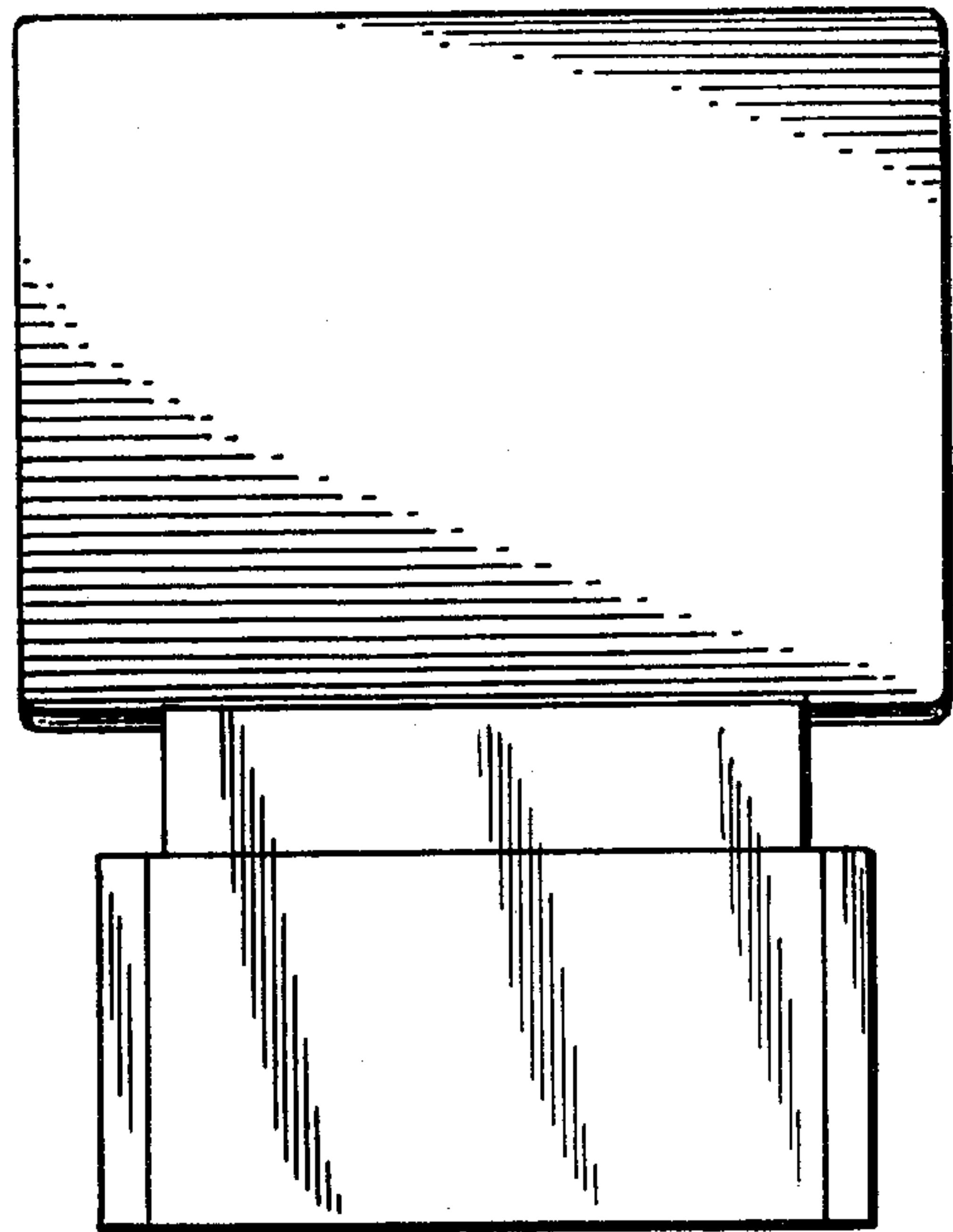

FIG. 7

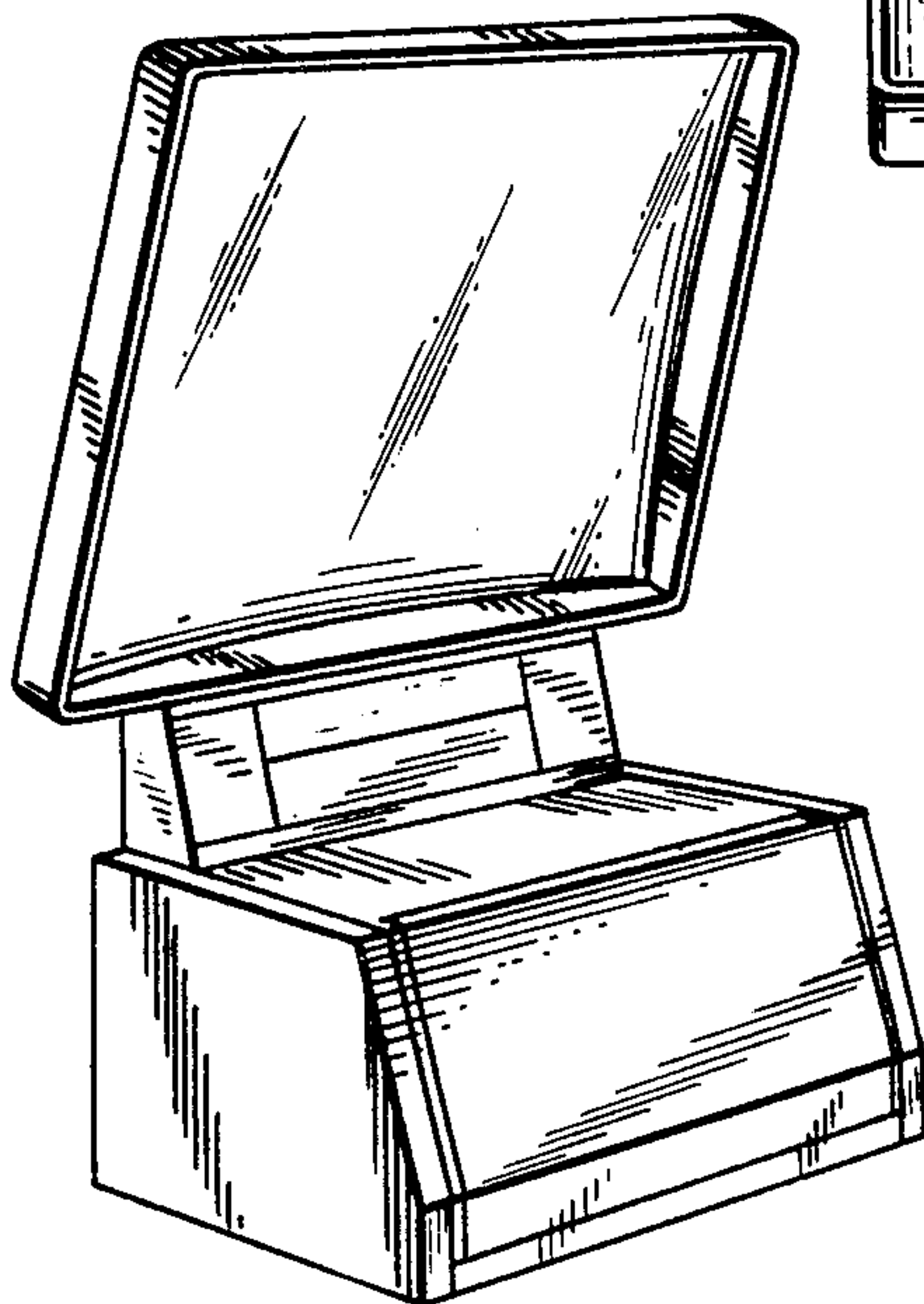
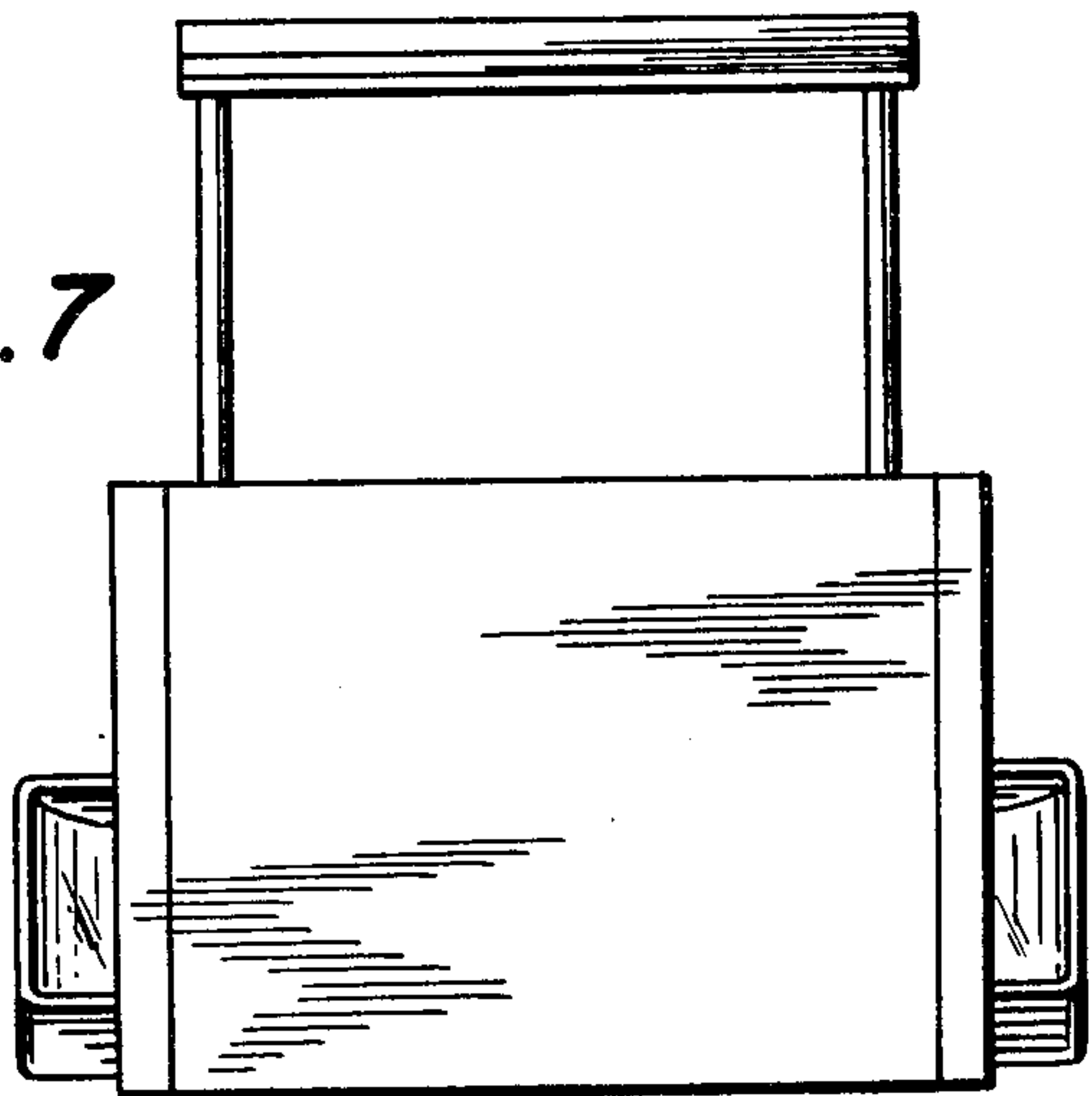

FIG. 8