

[54] PACKAGING CONTAINER

[75] Inventor: Rodney D. Borst, Oregon, Wis.

[73] Assignee: Seron Manufacturing Company, Joliet, Ill.

[**] Term: 14 Years

[21] Appl. No.: 377,061

[22] Filed: May 11, 1982

[52] U.S. Cl. D9/415

[58] Field of Search 206/463, 462, 461, 471, 206/495; D9/415, 418, 424, 426

[56] References Cited

U.S. PATENT DOCUMENTS

D. 214,996	8/1969	Cline	D9/415
3,861,528	1/1975	Damuth	206/463
4,020,694	5/1977	Mayhew	206/461 X

Primary Examiner—Robert C. Spangler
Attorney, Agent, or Firm—Wood, Dalton, Phillips,
Mason & Rowe

[57] CLAIM

The ornamental design for a packaging container, substantially as shown and described.

DESCRIPTION

FIG. 1 is a perspective view of a packaging container showing my new design;
 FIG. 2 is a side elevational view showing the side opposite that seen in FIG. 1;
 FIG. 3 is a top plan view;
 FIG. 4 is a bottom plan view;
 FIG. 5 is an elevational view looking from the left of FIG. 2;
 FIG. 6 is an elevational view looking from the right of FIG. 2; and
 FIG. 7 is a perspective view with the packaging container in a partially opened condition.

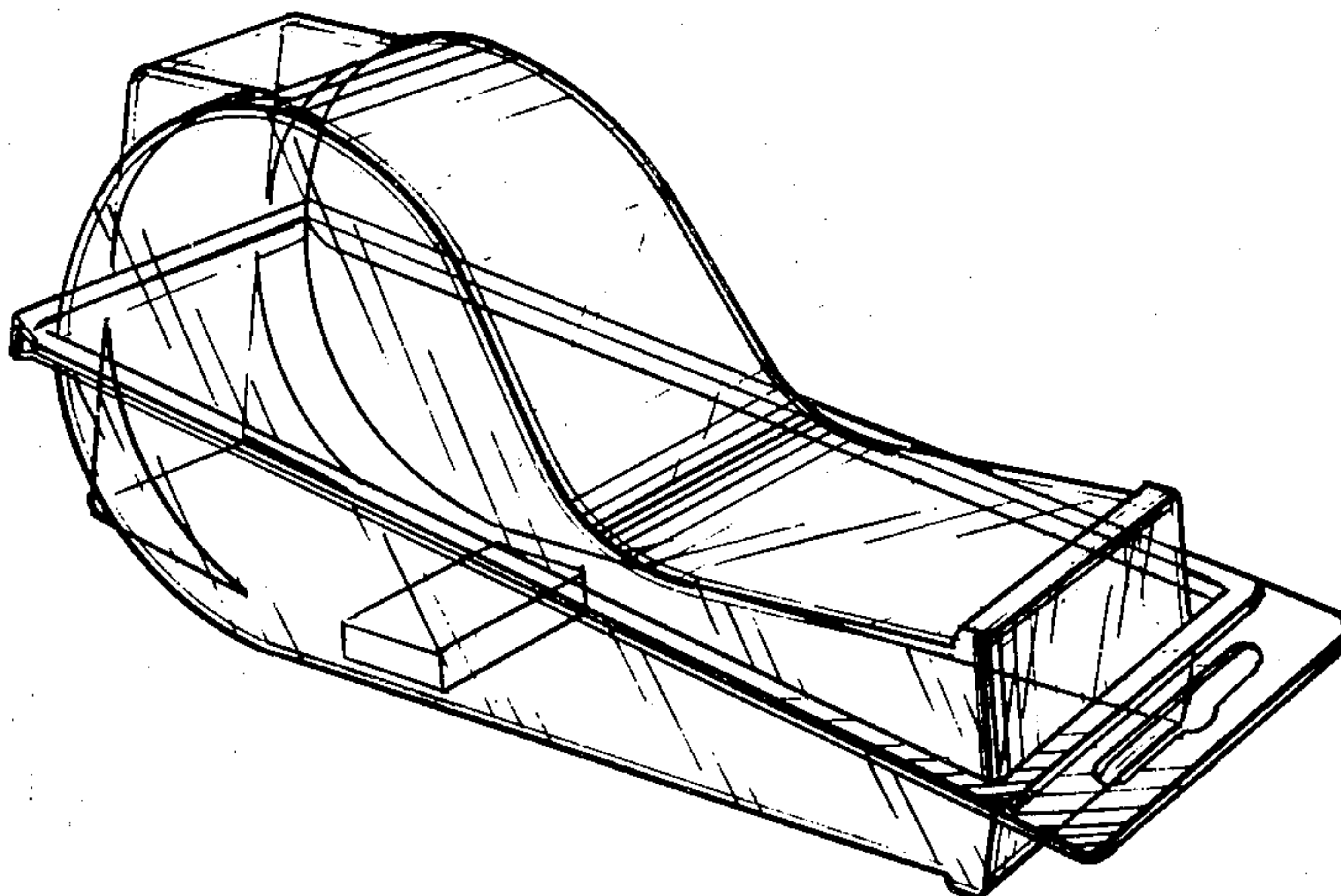

FIG. 1.

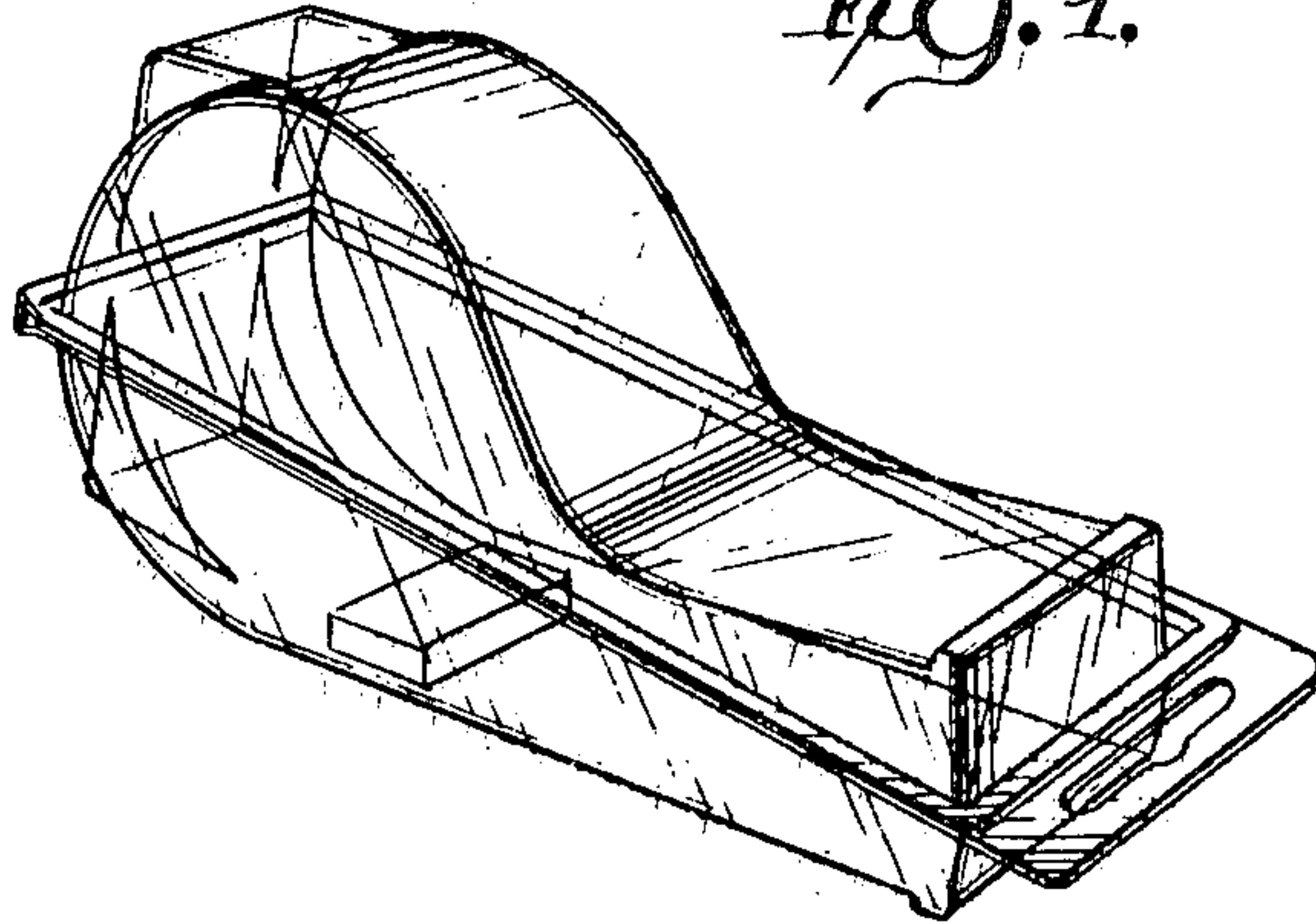

FIG. 2.

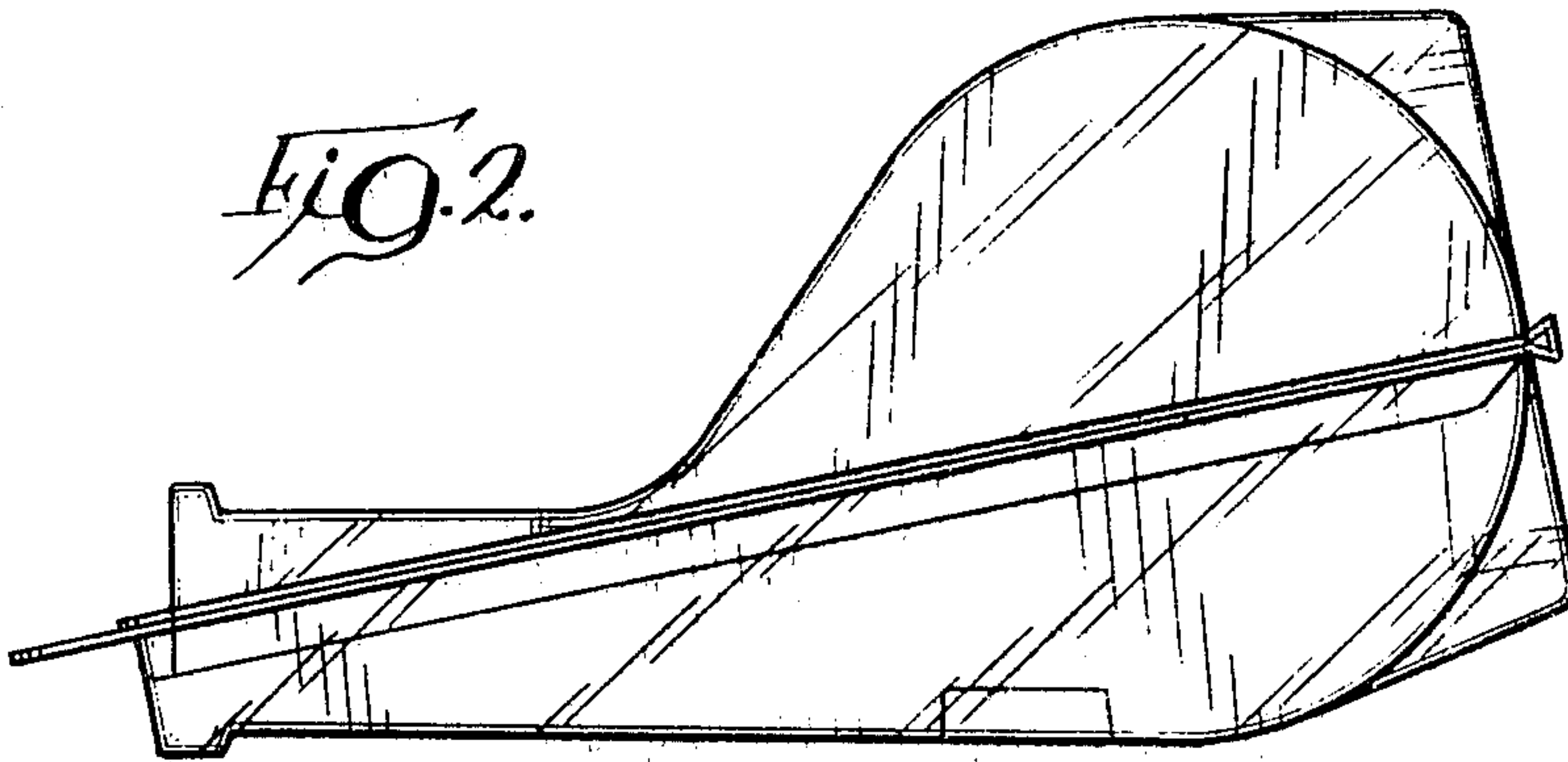

FIG. 3.

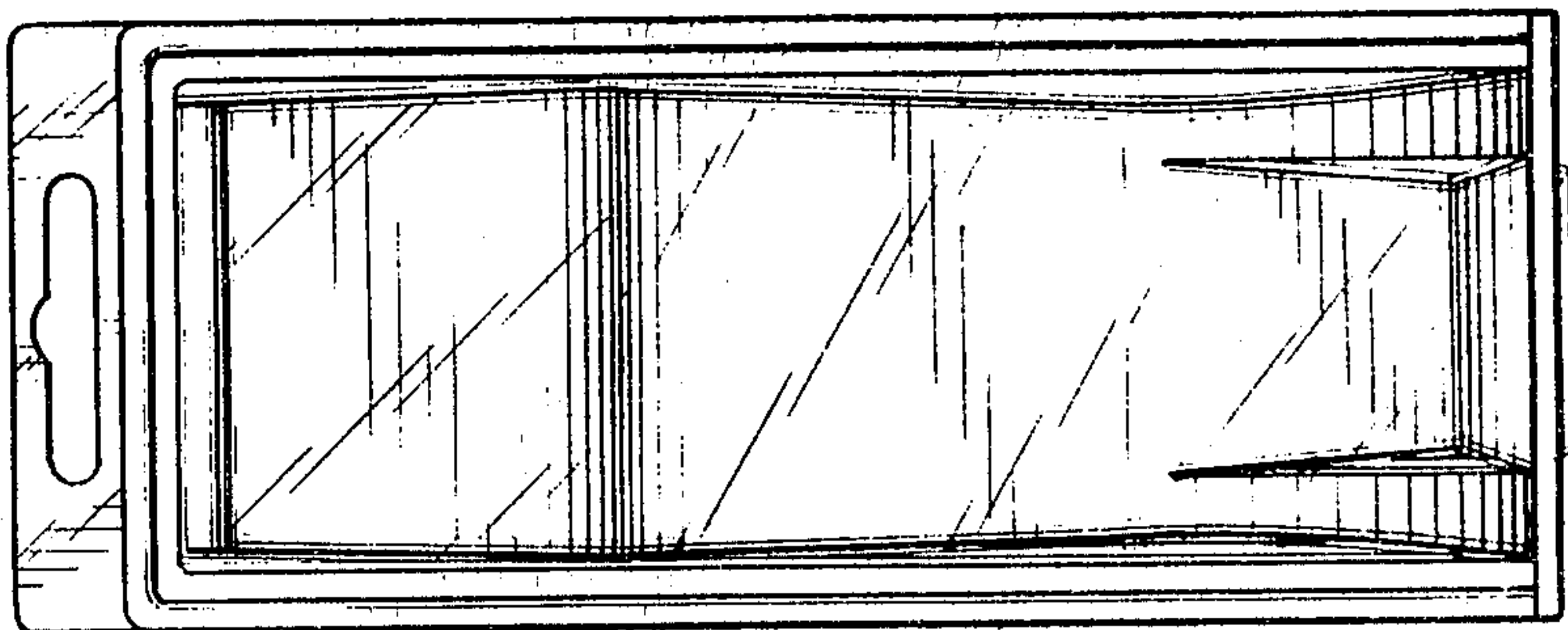

FIG. 4.

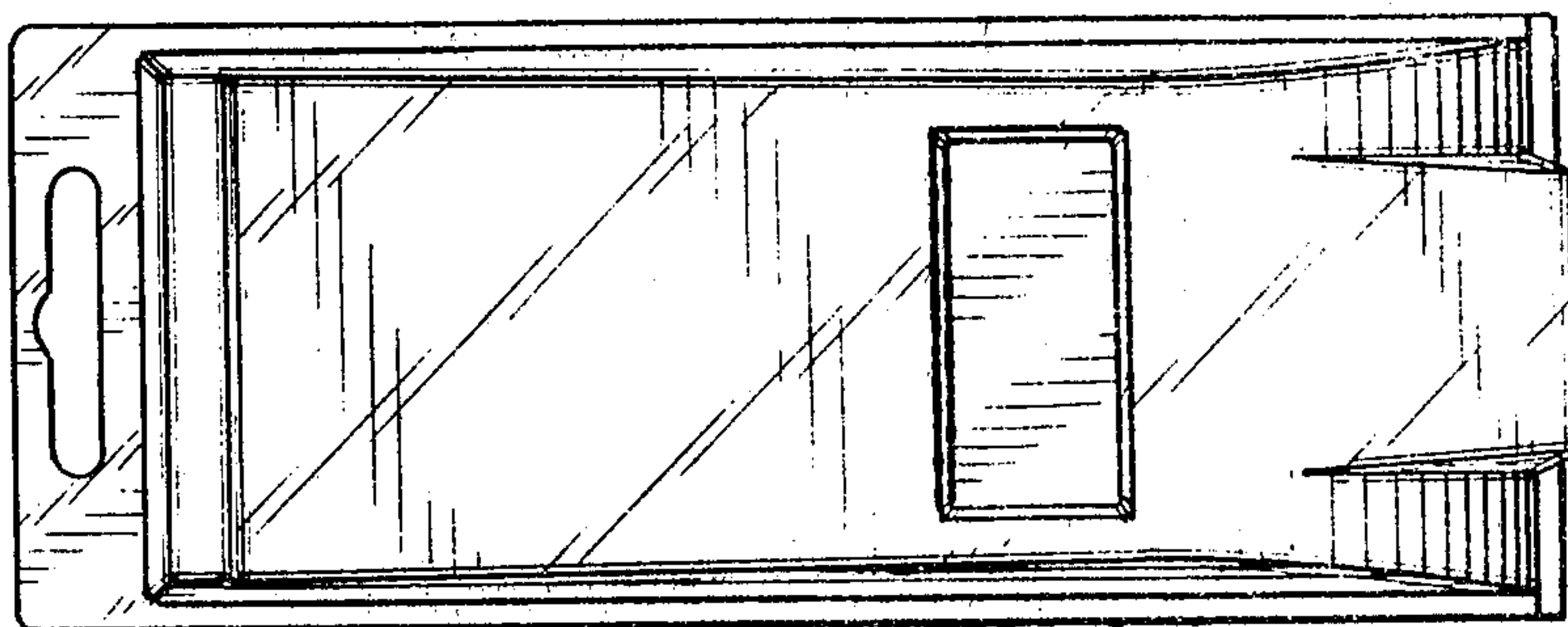

Fig. 5.

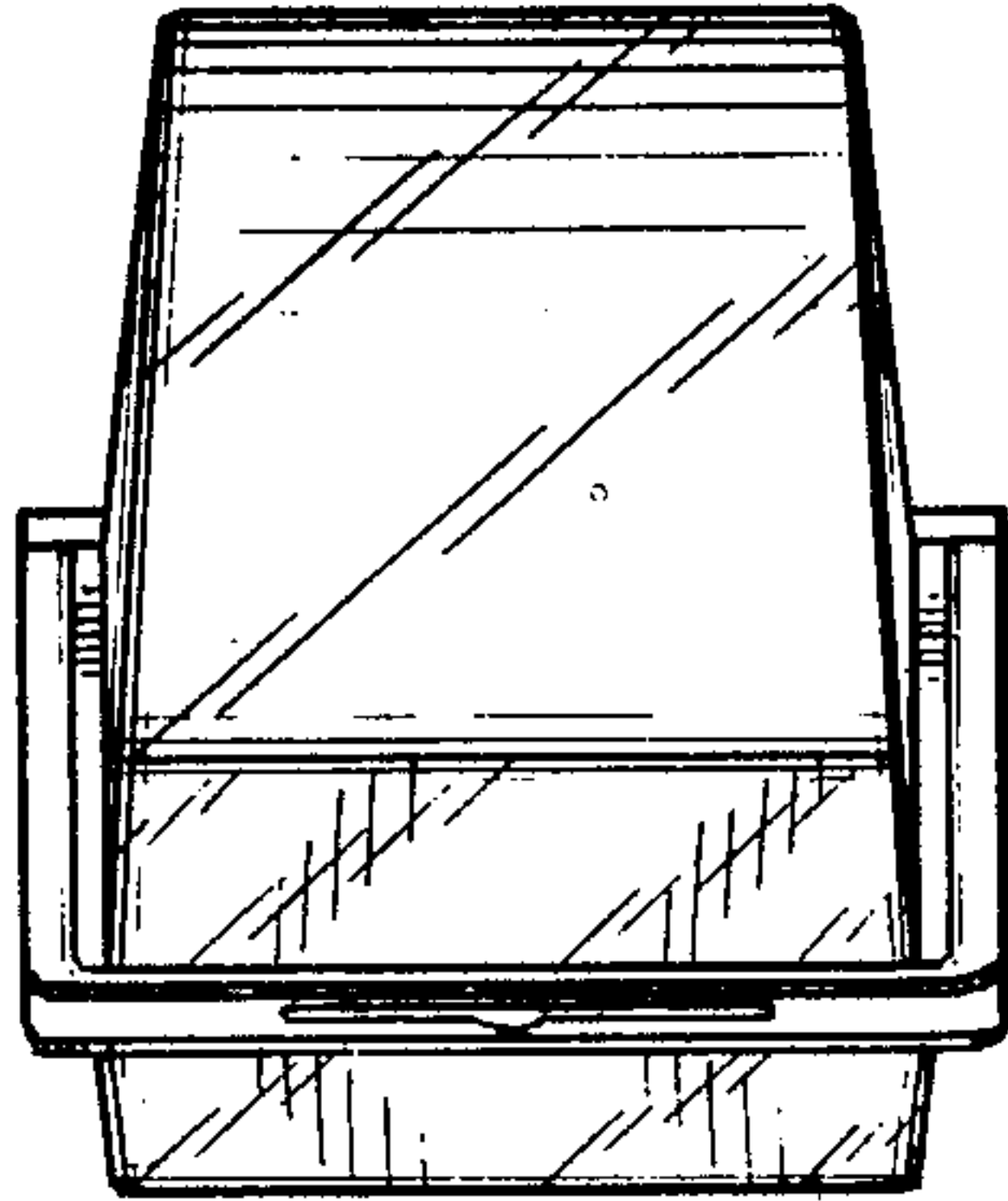

Fig. 6.

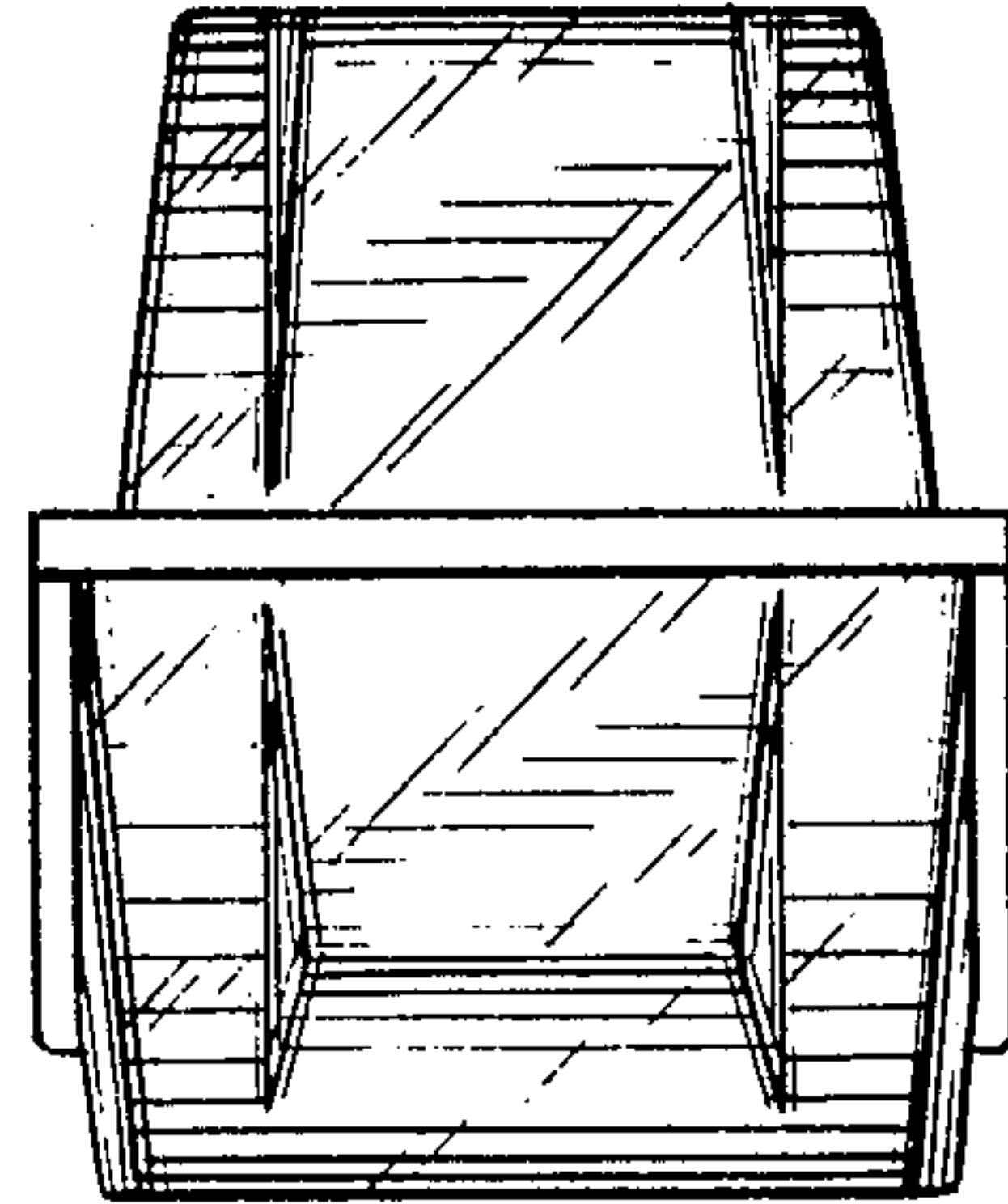

Fig. 7.

