

[54] BARBECUE FOR PLACEMENT IN AN OPENING IN A CABINET, TABLE OR THE LIKE

[75] Inventors: Susumu Naito; Kotaro Tanaka, both of Nagoya, Japan

[73] Assignee: Rinnai Kabushiki Kaisha, Aichi, Japan

[**] Term: 14 Years

[21] Appl. No.: 303,184

[22] Filed: Sep. 17, 1981

[30] Foreign Application Priority Data

Mar. 27, 1981 [JP] Japan 56-12472

[52] U.S. Cl. D7/337

[58] Field of Search D7/332, 333, 334, 335, D7/336, 337; 126/25 R, 25 A, 25 AA, 25 B, 25 C, 9 R, 9 A, 9 B, 29, 30

[56] References Cited

U.S. PATENT DOCUMENTS

- D. 184,876 4/1959 Joseph D7/337
- D. 187,095 1/1960 Joseph D7/337

OTHER PUBLICATIONS

Drive-In Restaurant, Aug. 1964, p.37 Anets Infra-Red Heat Broiler.

Restaurant Equipment Dealer, Jul. 1964, p. 13 Cecil-ware's Char-Broiler #BC 1824.
Institutions, Nov. 1, 1980, p. 128 Roundup TM Steam Food Warmer.

Primary Examiner—Wallace R. Burke
Assistant Examiner—Lynn Wilder
Attorney, Agent, or Firm—Armstrong, Nikaido, Marmelstein & Kubovcik

[57] CLAIM

The ornamental design for a barbecue for placement in an opening in a cabinet, table or the like, as shown and described.

DESCRIPTION

FIG. 1 is a front elevational view of a barbecue for placement in an opening in a cabinet, table or the like, showing our new design;

FIG. 2 is a top plan view thereof;

FIG. 3 is a rear elevational view thereof;

FIG. 4 is a bottom plan view thereof;

FIG. 5 is a left side elevational view thereof;

FIG. 6 is a right side elevational view thereof;

FIG. 7 is a left side elevational view of the same with an upper lid being open;

FIG. 8 is a top plan view of the same under the same condition;

FIG. 9 is a perspective view of the same with the lid being closed; and

FIG. 10 is a perspective view of the same with the lid being open.

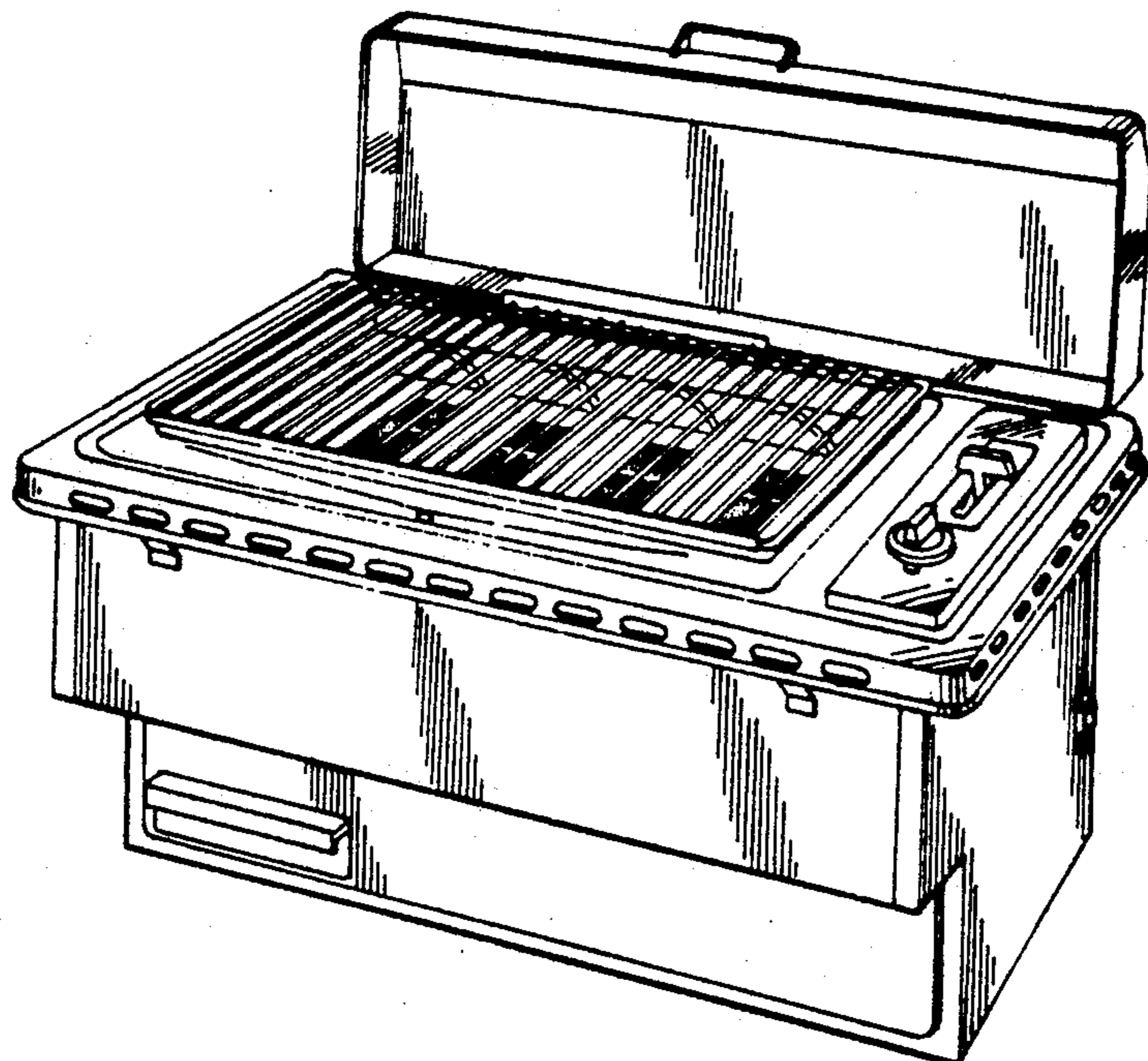

FIG. 1

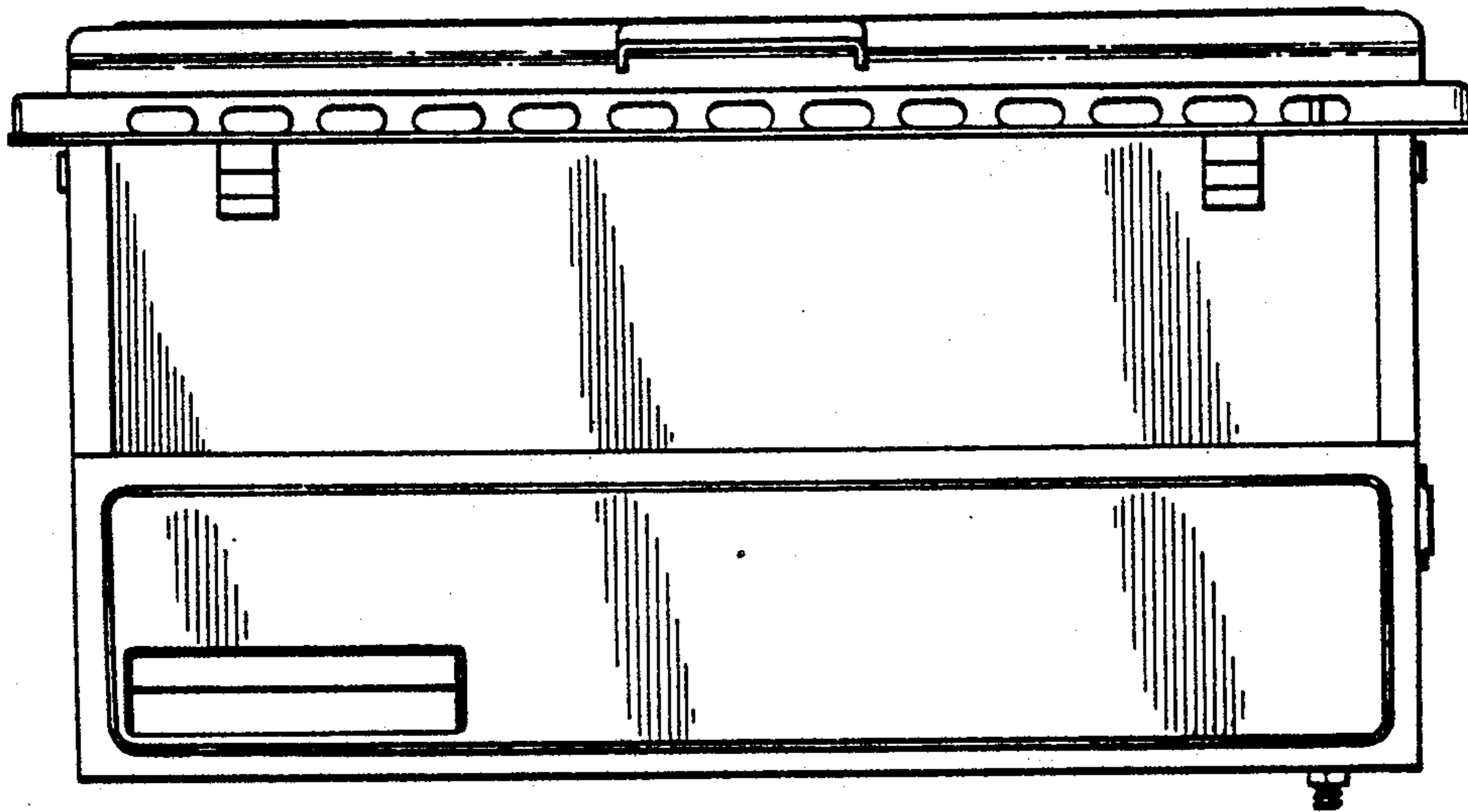

FIG. 2

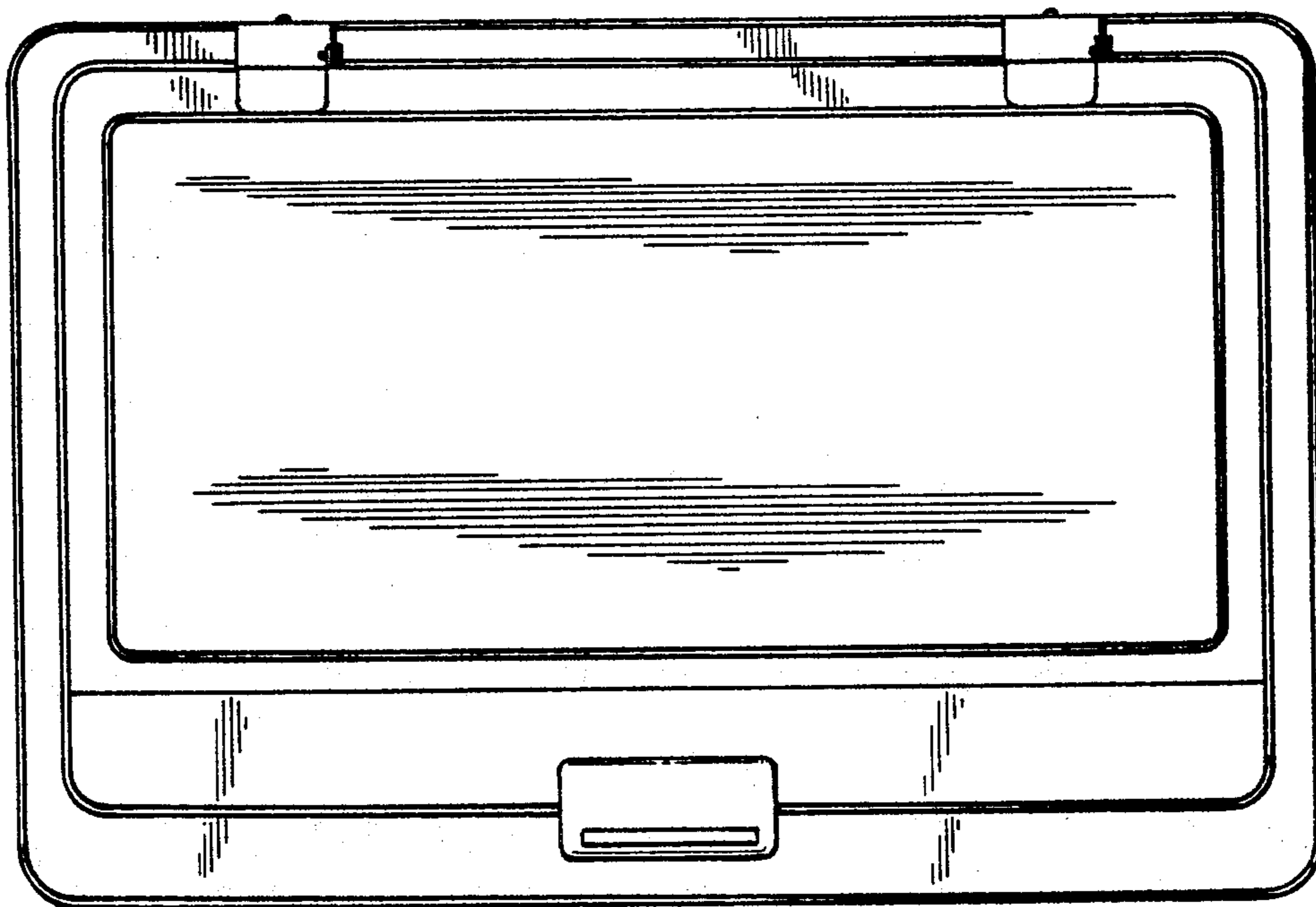

FIG. 3

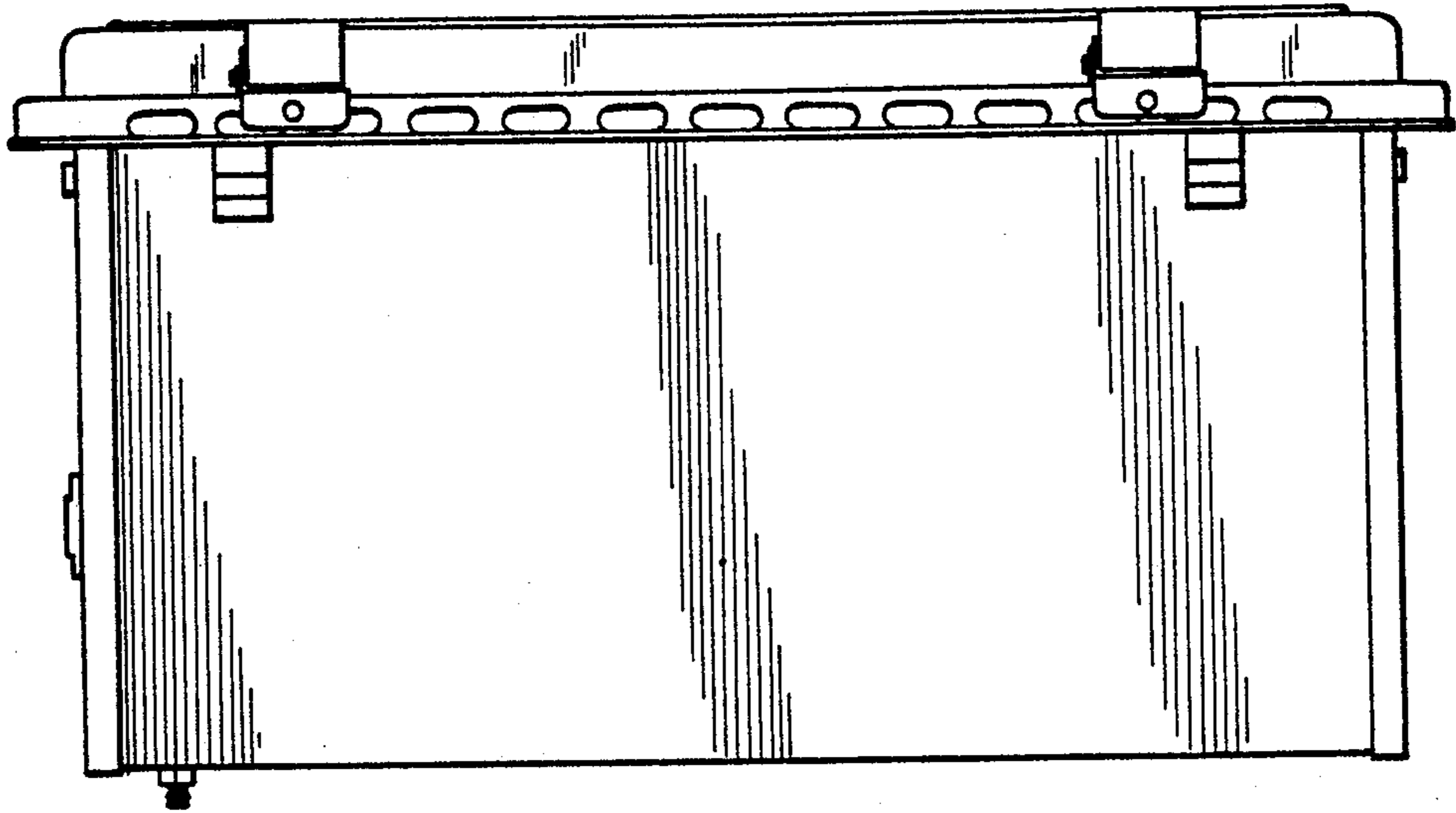

FIG. 4

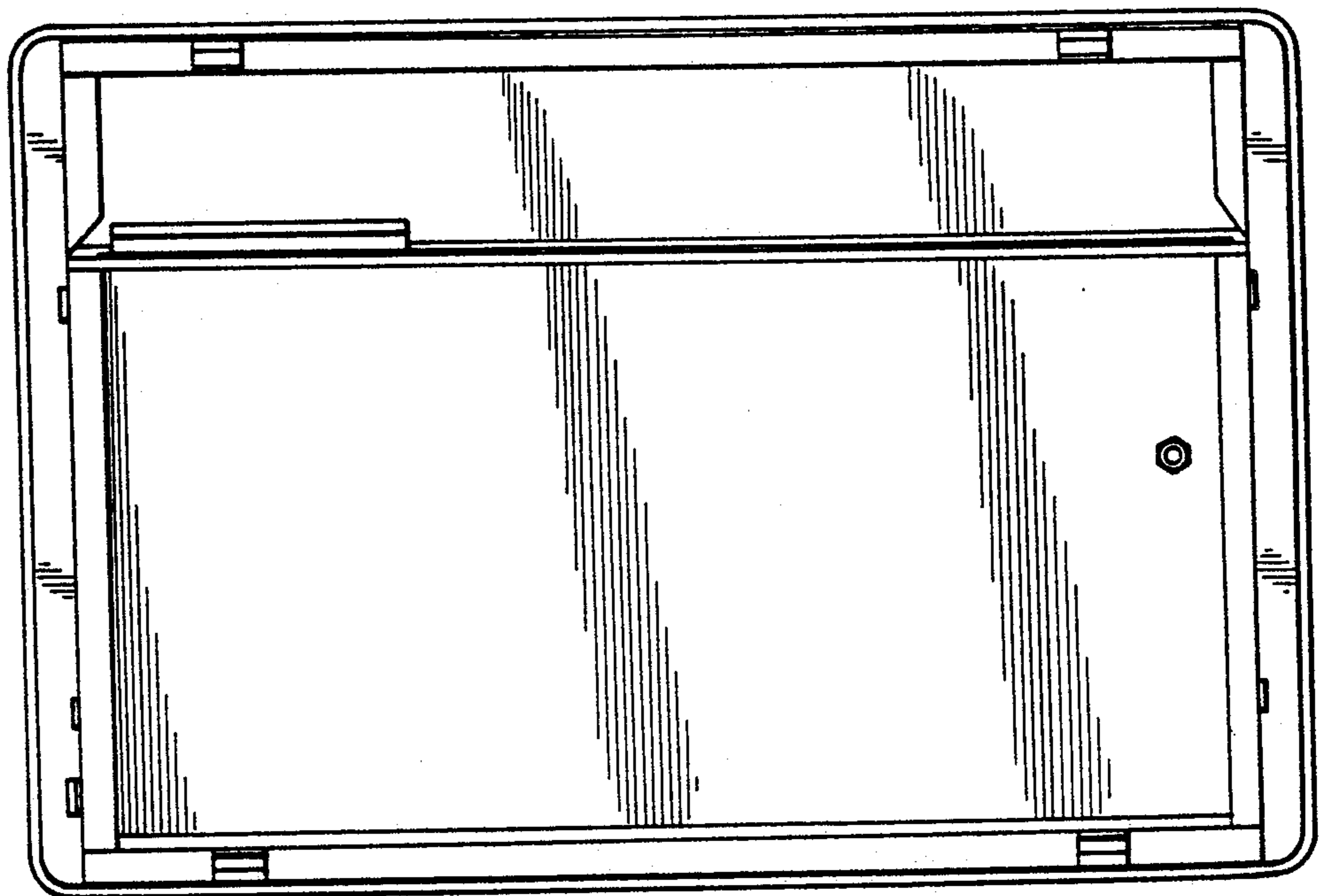

FIG. 5

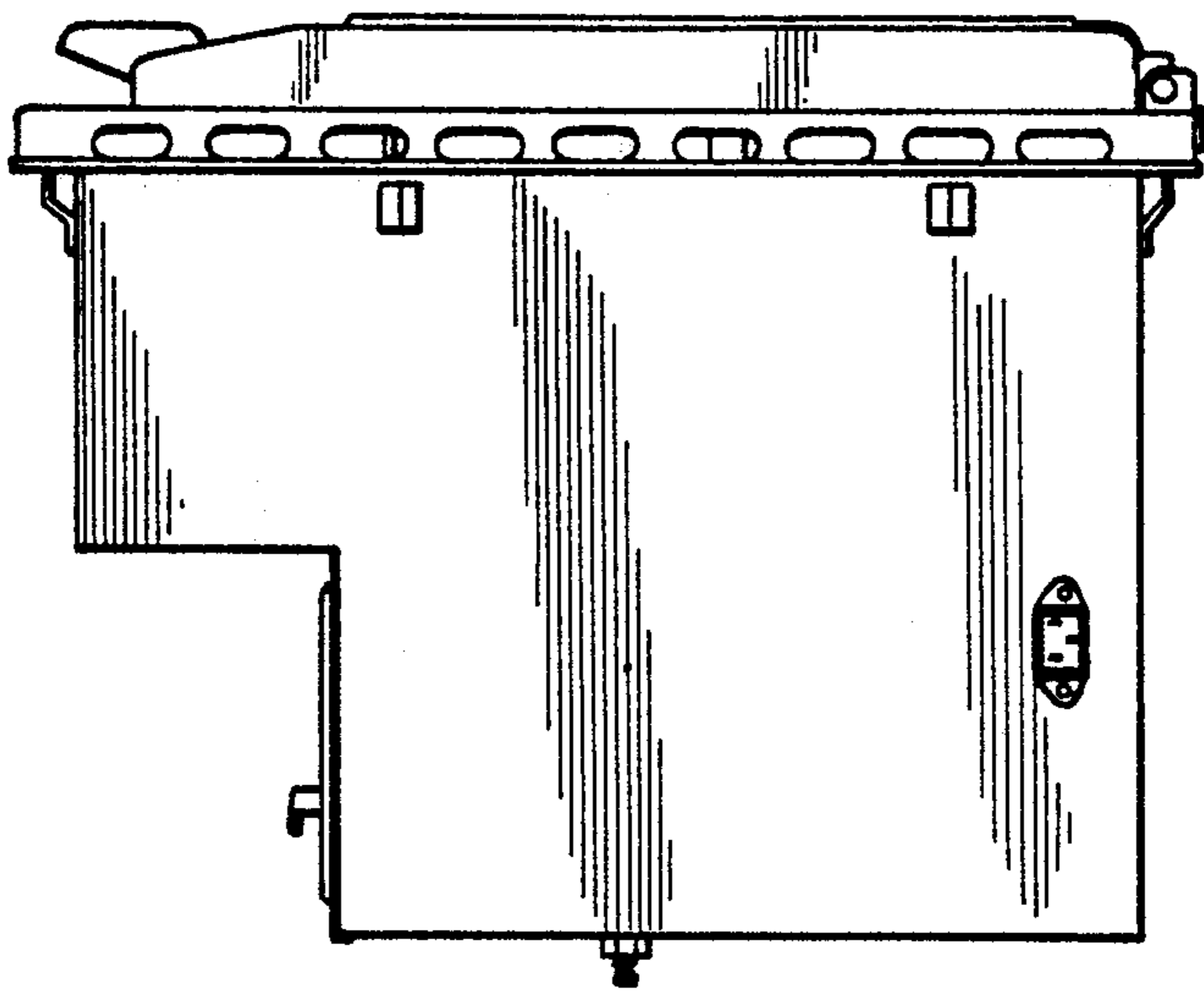

FIG. 6

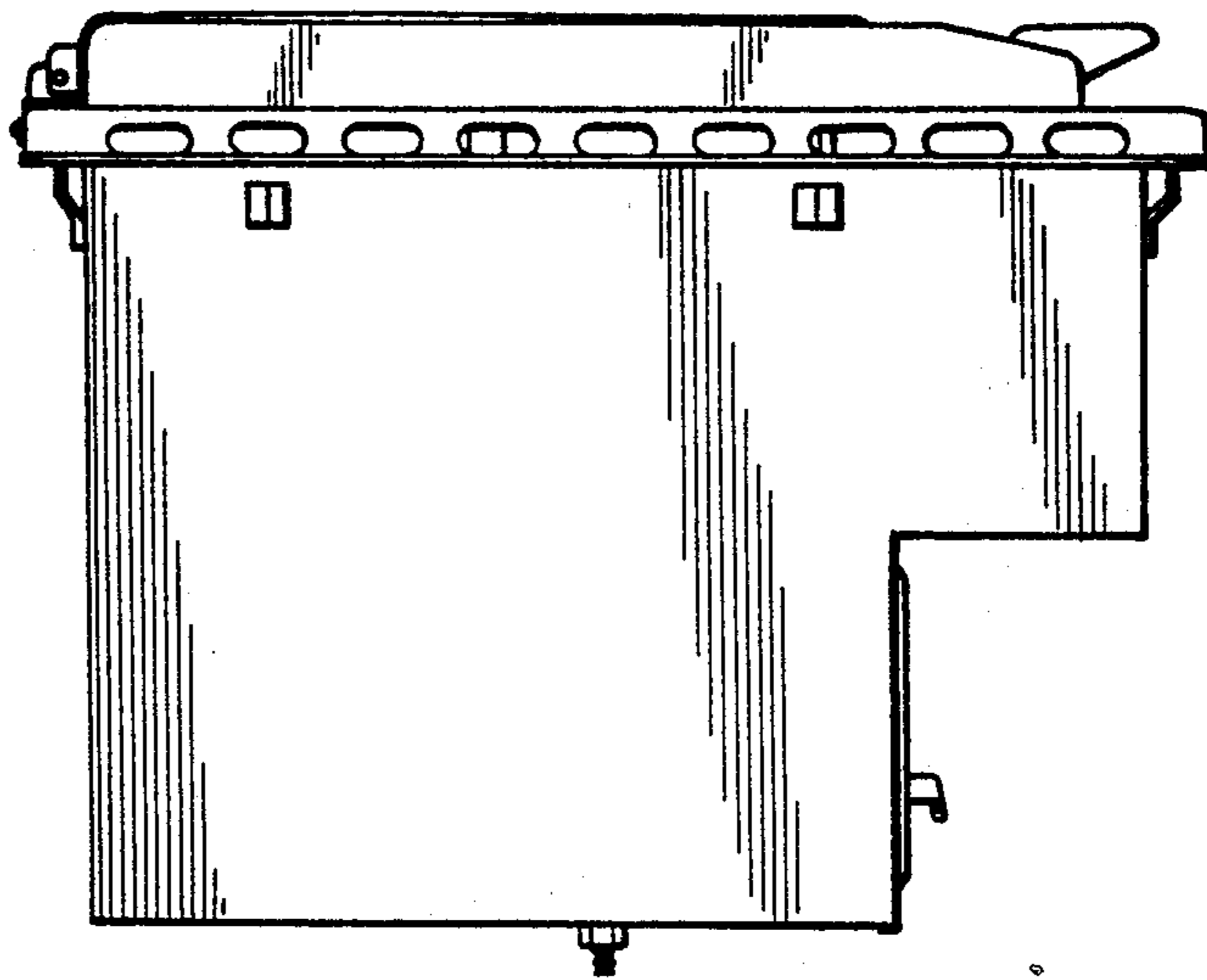

FIG. 7

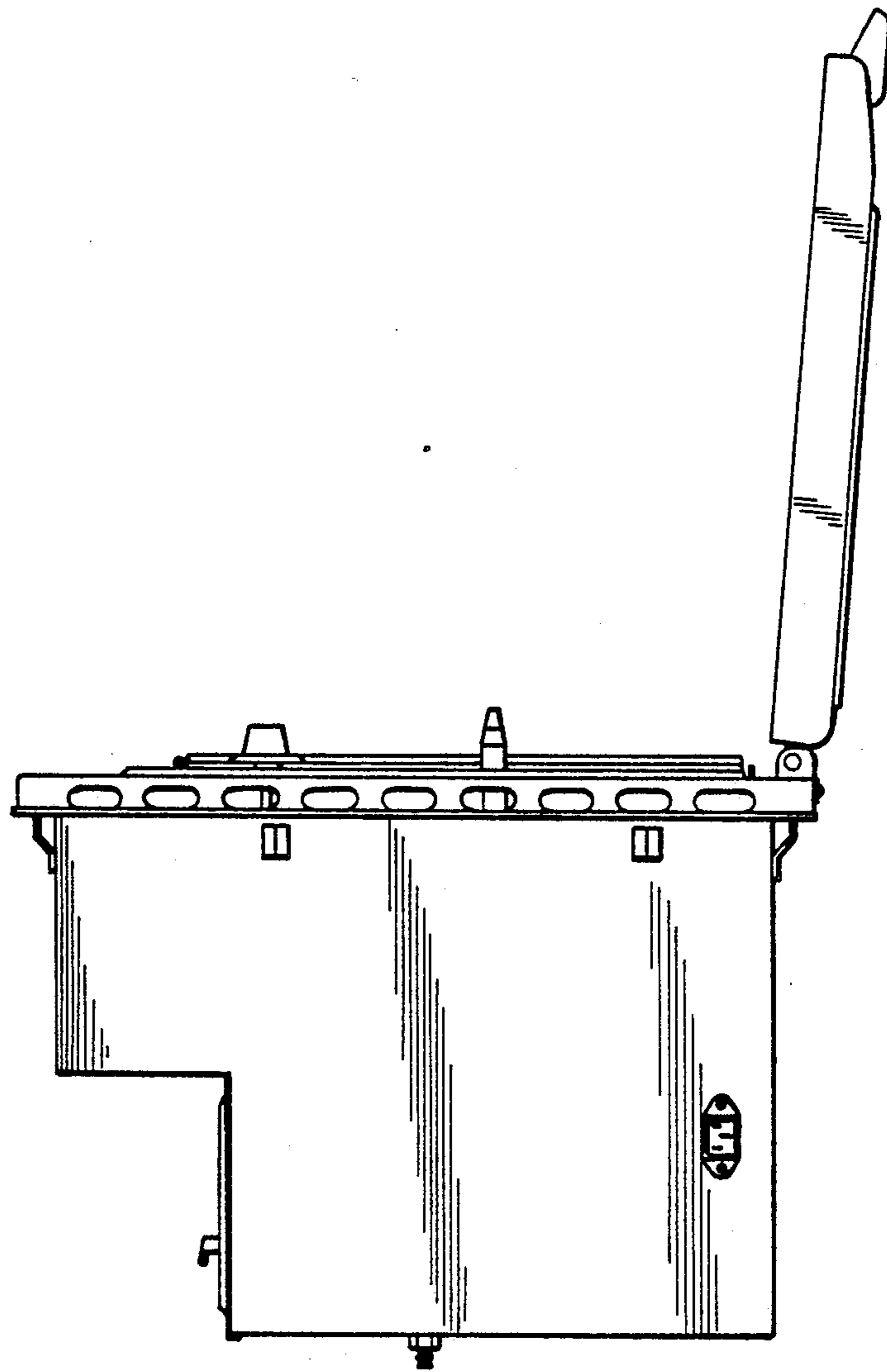

FIG. 8

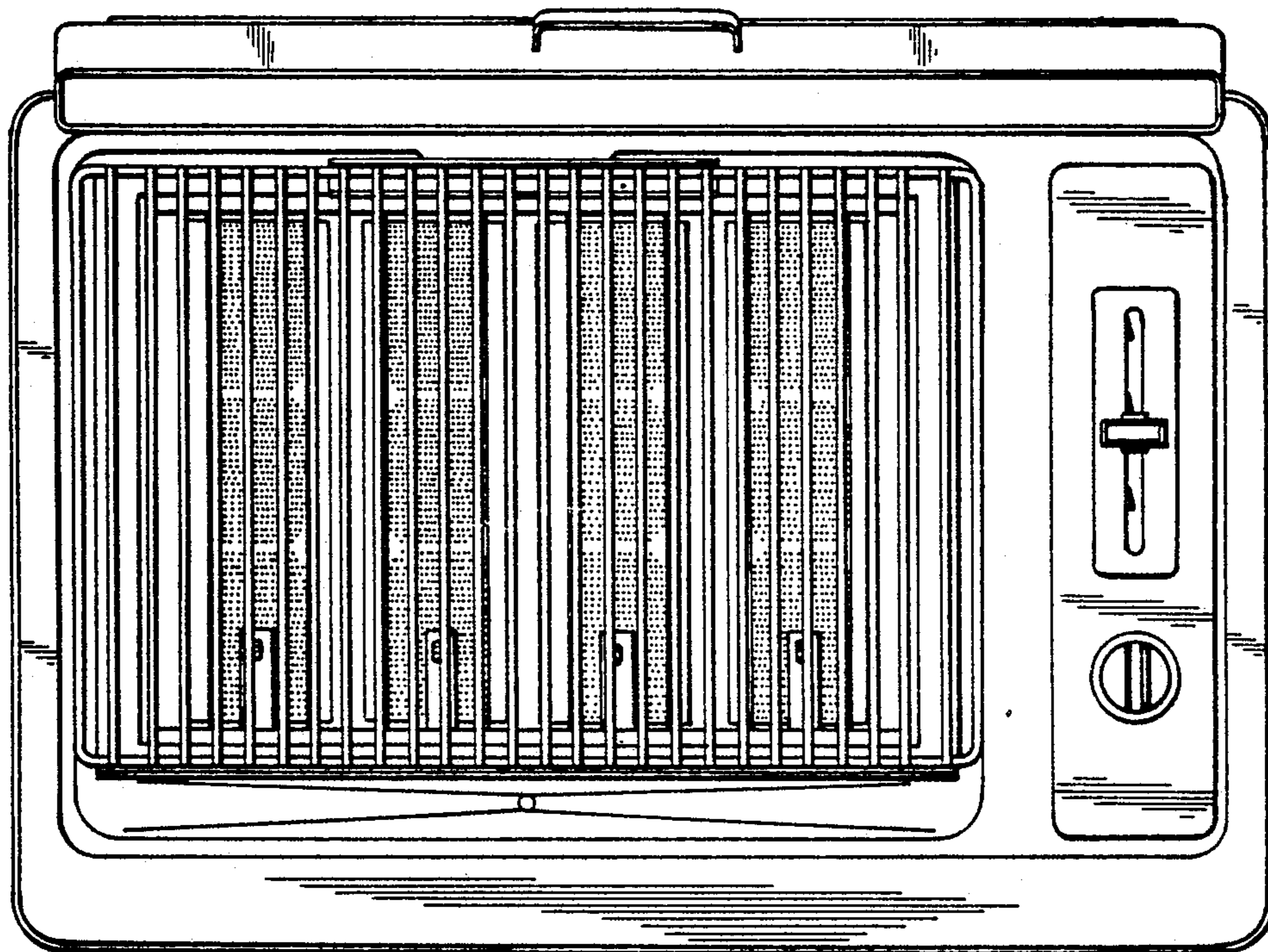

FIG. 9

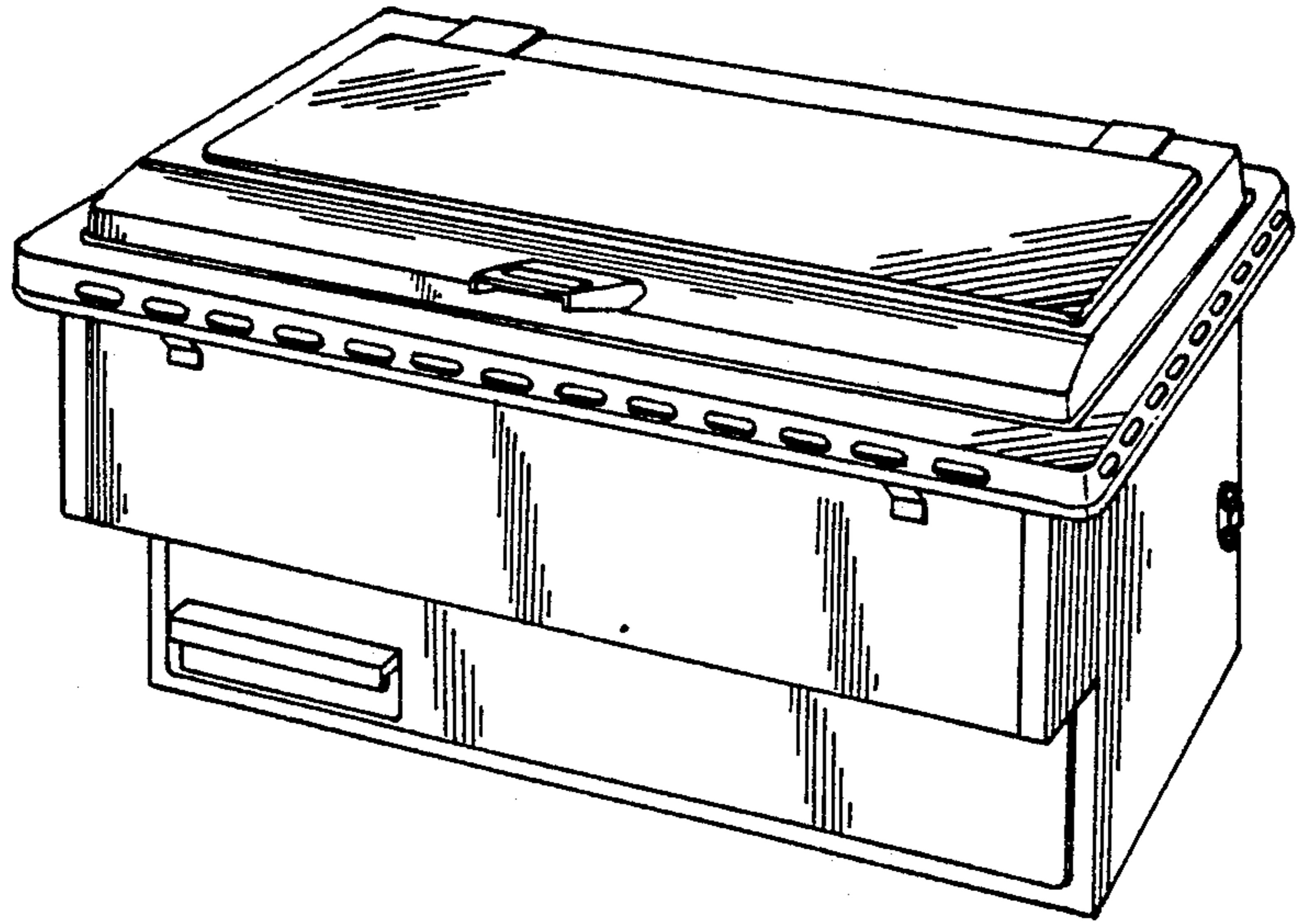

FIG. 10

