

[54] DISPENSER FOR INSTANT COFFEE, TEA, OR THE LIKE

[75] Inventor: John H. Starke, New City, N.Y.

[73] Assignee: Innovative Enterprises, Inc., New City, N.Y.

[**] Term: 14 Years

[21] Appl. No.: 401,301

[22] Filed: Jul. 22, 1982

397,788	2/1889	Eagan	222/430
1,449,571	3/1923	Younger	222/510 X
1,749,853	3/1930	Smith	222/510 X
2,123,606	7/1938	Latocha	222/430 X
2,488,254	11/1949	Allen	222/510 X
2,490,721	12/1949	Via	222/476
3,136,457	6/1964	Via, Sr.	D7/53 X

Primary Examiner—Winifred F. Herrmann
Attorney, Agent, or Firm—Ostrolenk, Faber, Gerb & Soffen

Related U.S. Application Data

[63] Continuation-in-part of Ser. No. 148,053, Jul. 29, 1980, abandoned.

[52] U.S. Cl. D7/52; D7/57

[58] Field of Search 222/476, 510, 430, 142.5, 222/196.1; D7/52, 54, 57, 399, 300, 308, 313

[56] References Cited

U.S. PATENT DOCUMENTS

D. 204,310	4/1966	Scheurn et al.	D7/76
D. 210,848	4/1968	Robb	D7/76 X
D. 242,380	11/1976	Struna et al.	D7/52 X
D. 258,257	2/1981	Bounds	D7/53

[57] CLAIM

The ornamental design for a dispenser for instant coffee, tea, or the like, as shown and described.

DESCRIPTION

FIG. 1 is a perspective view of a dispenser for instant coffee, tea, or the like, showing my new design; FIG. 2 is a front elevational view thereof; FIG. 3 is a top view thereof; FIG. 4 is a bottom view thereof; FIG. 5 is a side view thereof, showing it in a different operative position than that shown in FIG. 2; FIG. 6 is a cross-sectional, elevational view thereof along the lines 6—6 of FIG. 3; and FIG. 7 is a fragmentary perspective view thereof in a different condition.

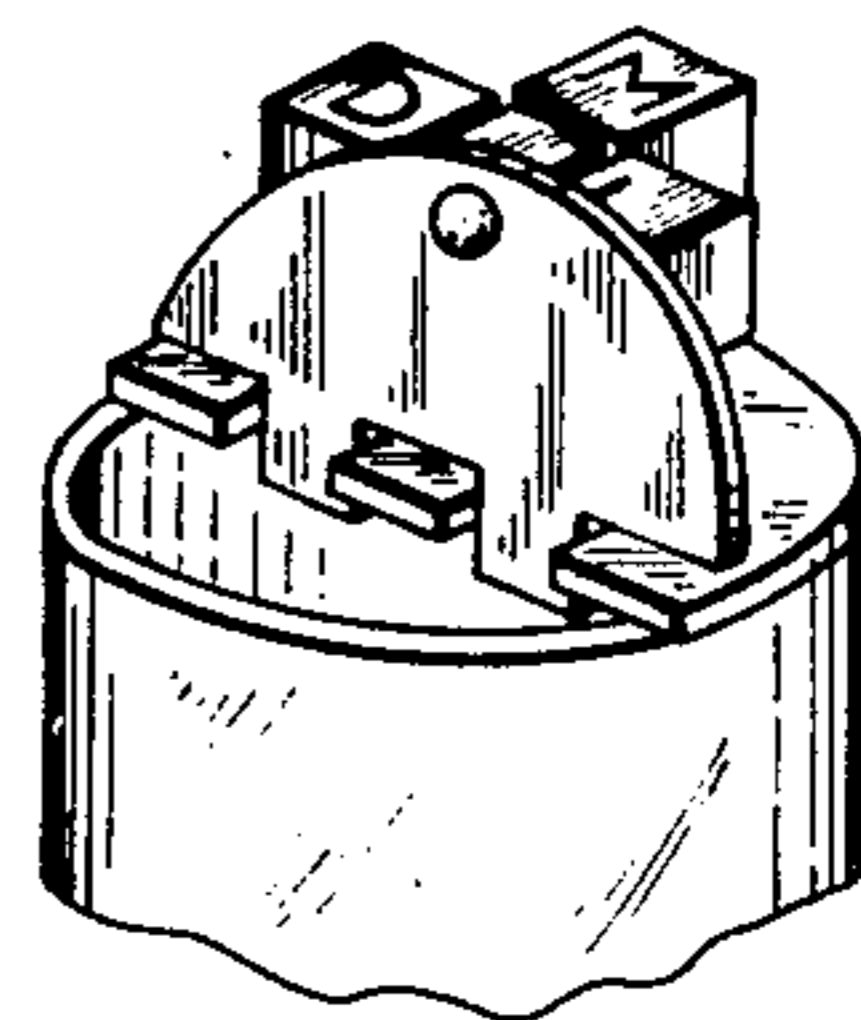
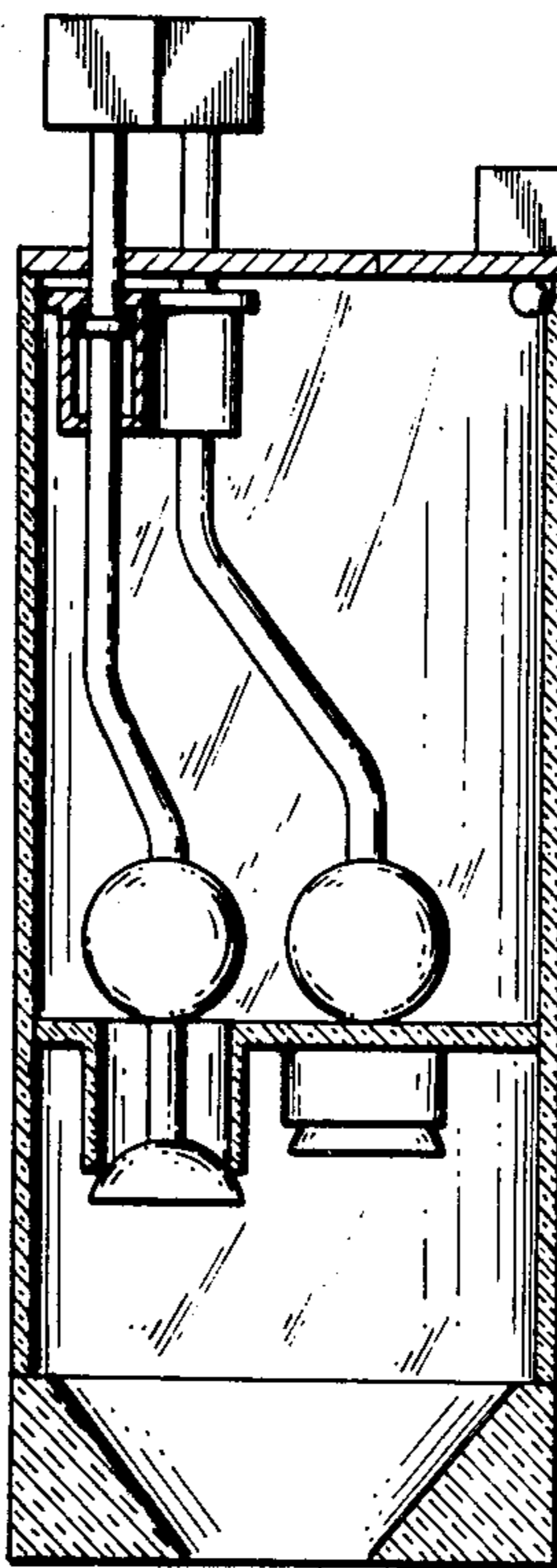
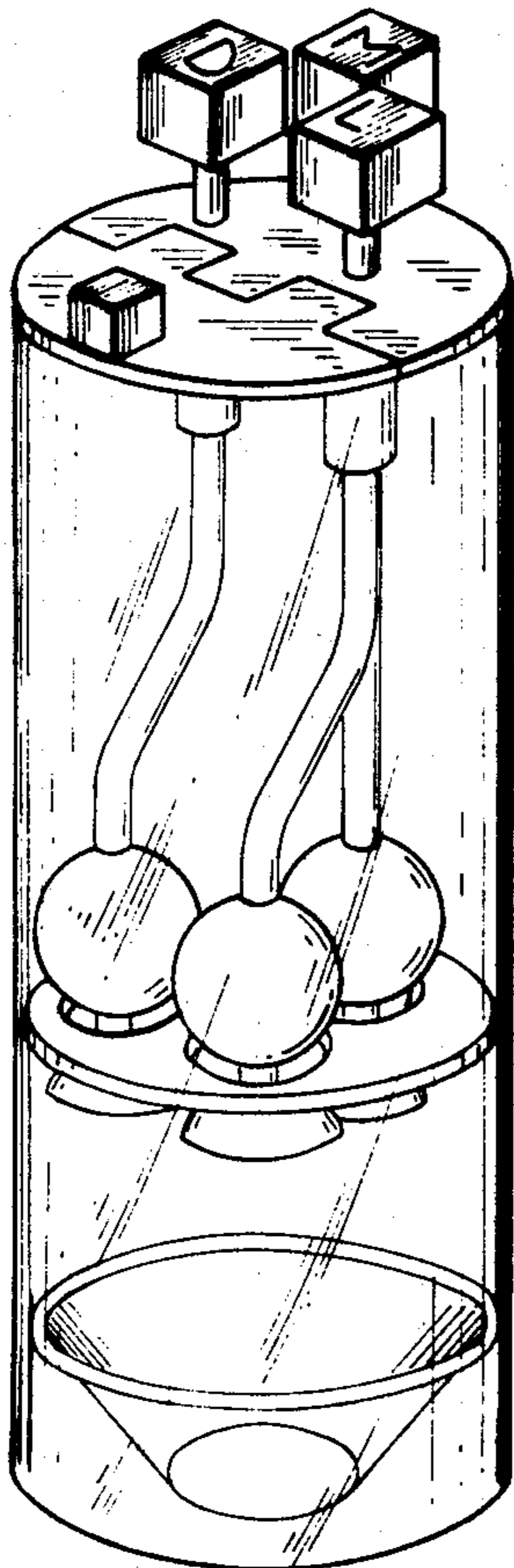

FIG. 1.

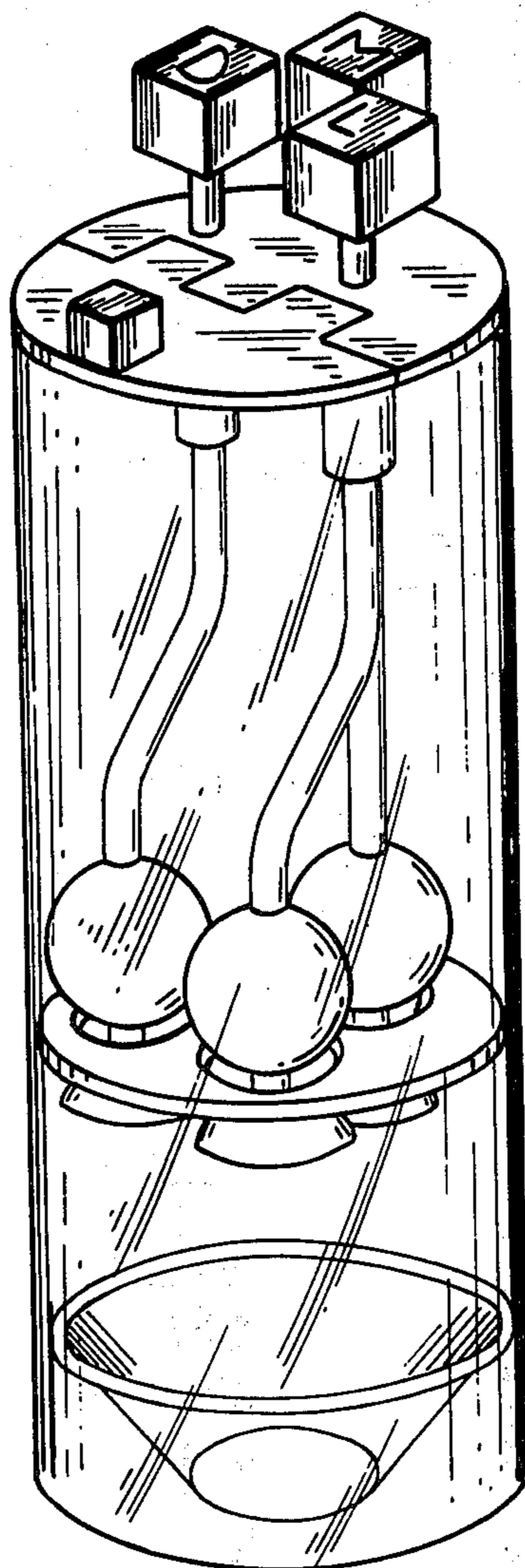

FIG. 2.

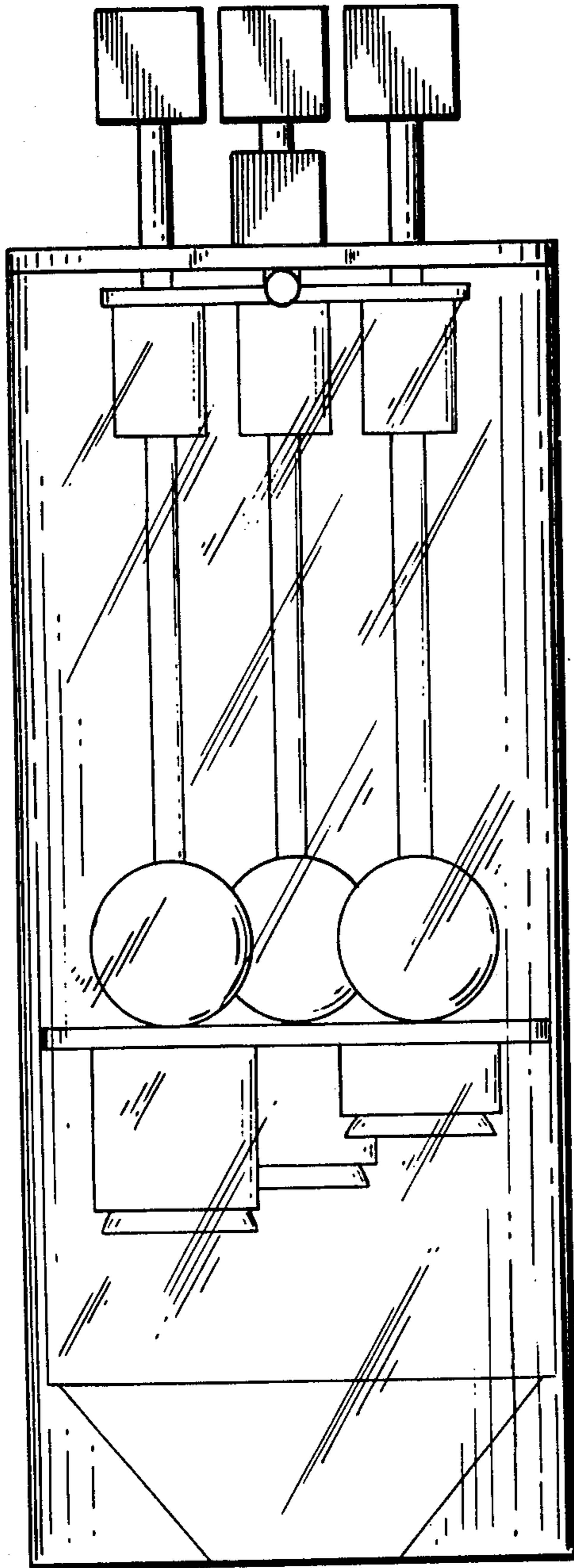

FIG. 3.

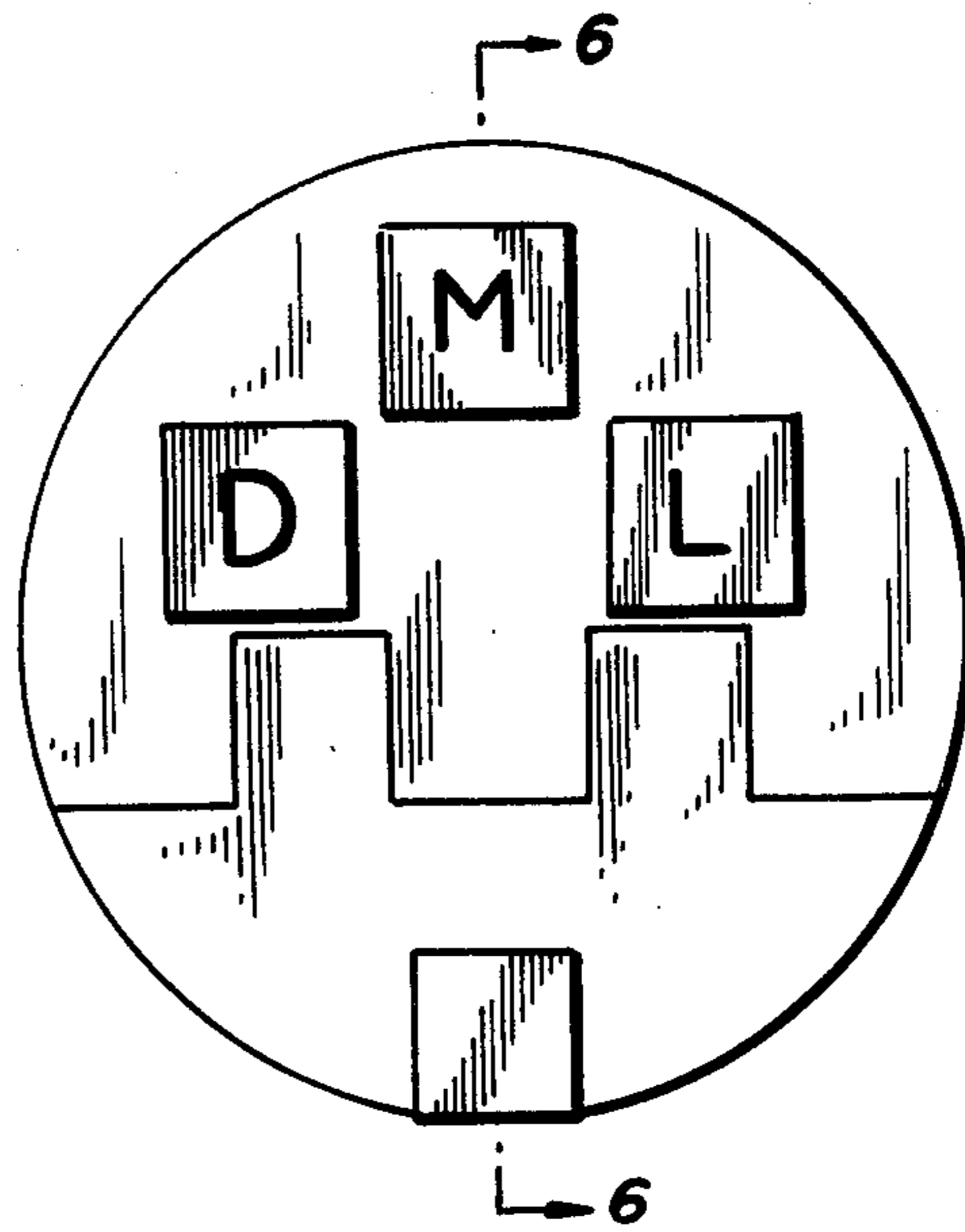

FIG. 4.

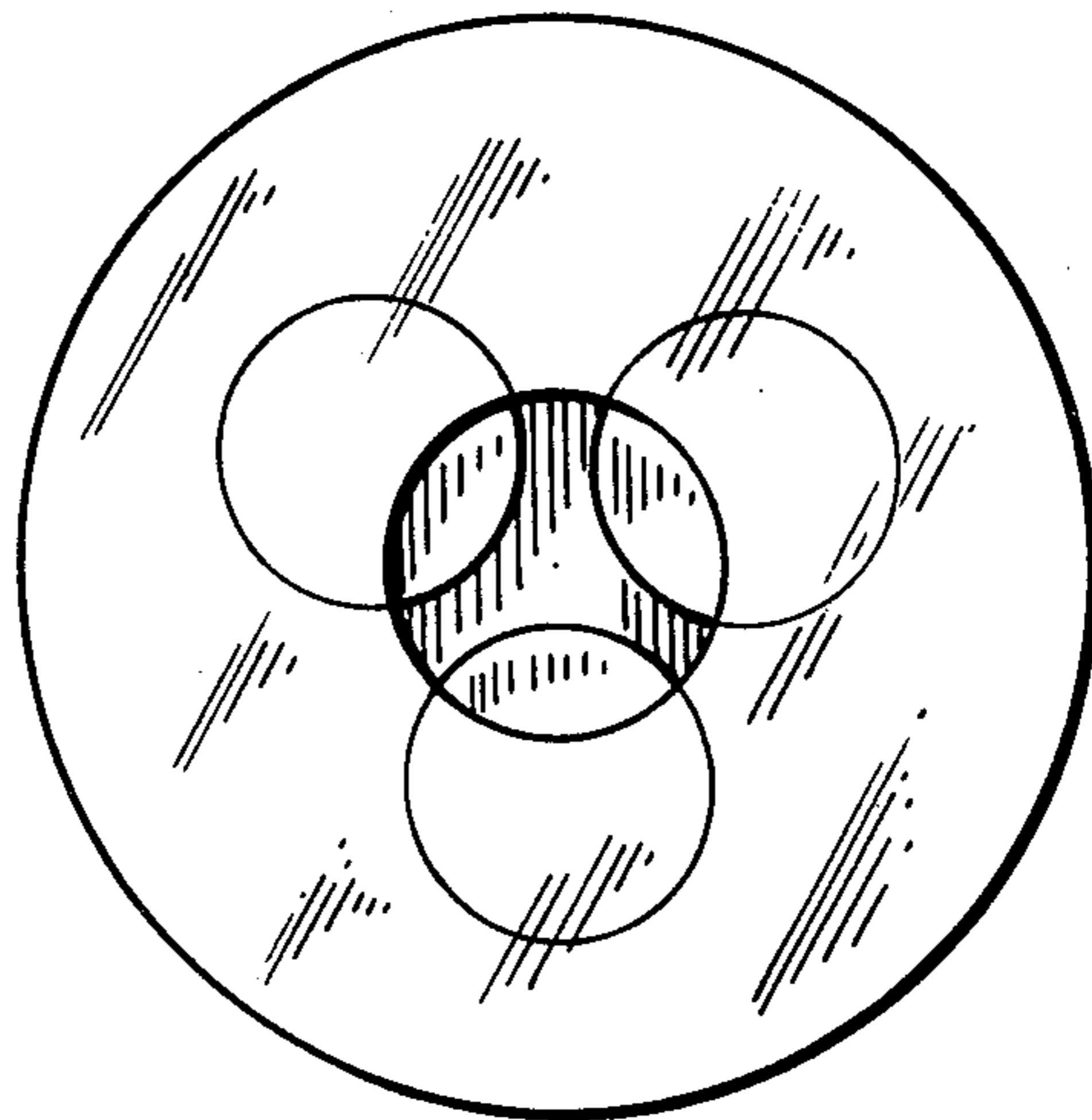

FIG. 5.

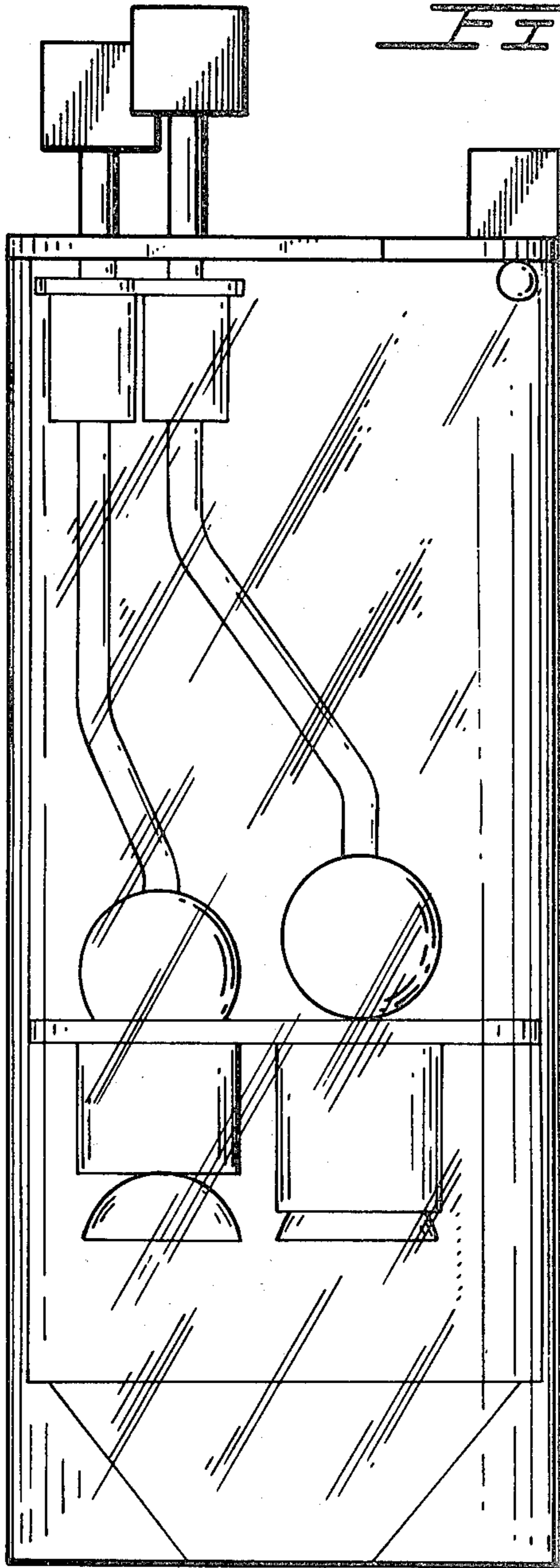

FIG. 6.

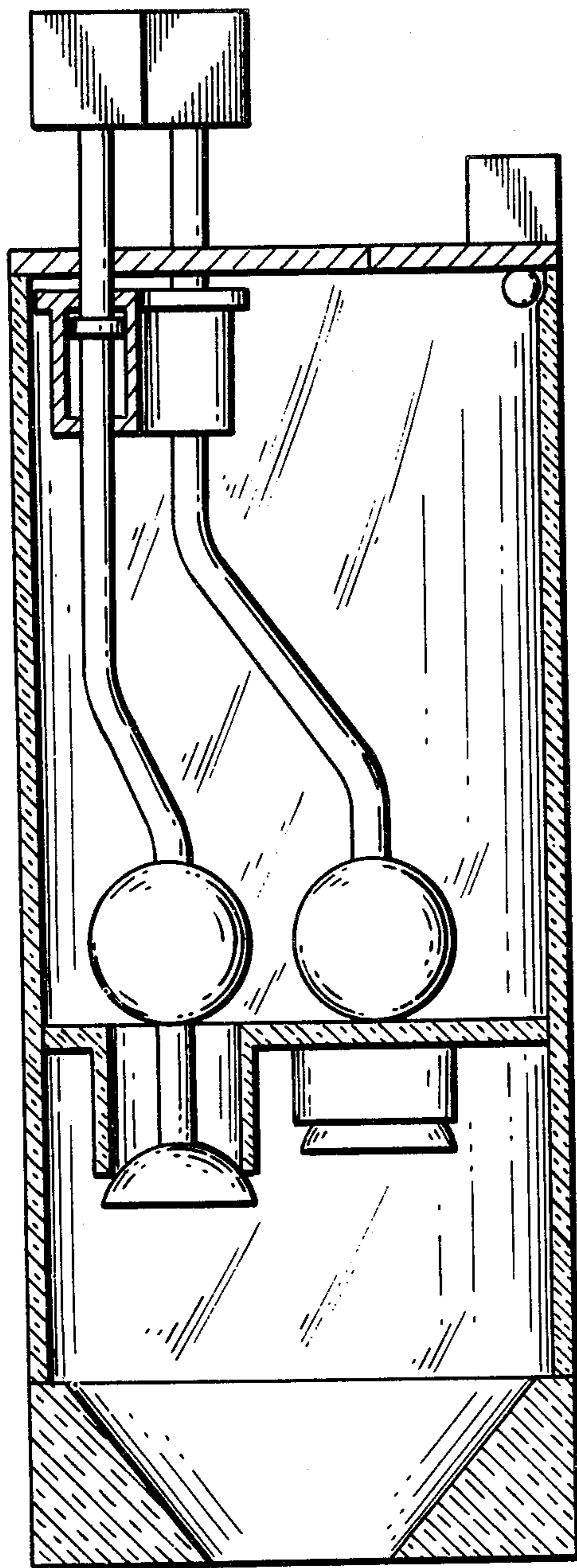

FIG. 7.

