

United States Patent [19]

Sartor

[11] Patent Number: **Des. 275,813**

[45] Date of Patent: **** Oct. 9, 1984**

[54] **SKI BOOT**

[75] Inventor: **Mariano Sartor, Montebelluna, Italy**

[73] Assignee: **NORDICA, S.p.A., Montebelluna, Italy**

[**] Term: **14 Years**

[21] Appl. No.: **367,843**

[22] Filed: **Apr. 13, 1982**

[30] **Foreign Application Priority Data**

Oct. 16, 1981 [IT] Italy 23250-B/81 [U]

[52] U.S. Cl. **D2/276**

[58] Field of Search **D2/264-324;**
36/1, 1.5, 96, 112-121, 59 C, 50

[56] **References Cited**

U.S. PATENT DOCUMENTS

3,535,800 10/1970 Stöhr **D2/276 X**

3,968,578 7/1976 Rathmell 36/121
4,043,059 8/1977 Rathmell 36/121

FOREIGN PATENT DOCUMENTS

2407681 7/1979 France 36/119

Primary Examiner—Louis S. Zarfes

Attorney, Agent, or Firm—Guido Modiano; Albert Josif

[57] CLAIM

The ornamental design for a ski boot, as shown.

DESCRIPTION

FIG. 1 is a lateral view of a ski boot showing my new design;

FIG. 2 is another lateral view thereof, opposite to that of FIG. 1;

FIG. 3 is a front perspective view thereof;

FIG. 4 is a rear perspective view thereof;

FIG. 5 is a top perspective view thereof;

FIG. 6 is a bottom plan view thereof;

FIG. 7 is a front right perspective view thereof.

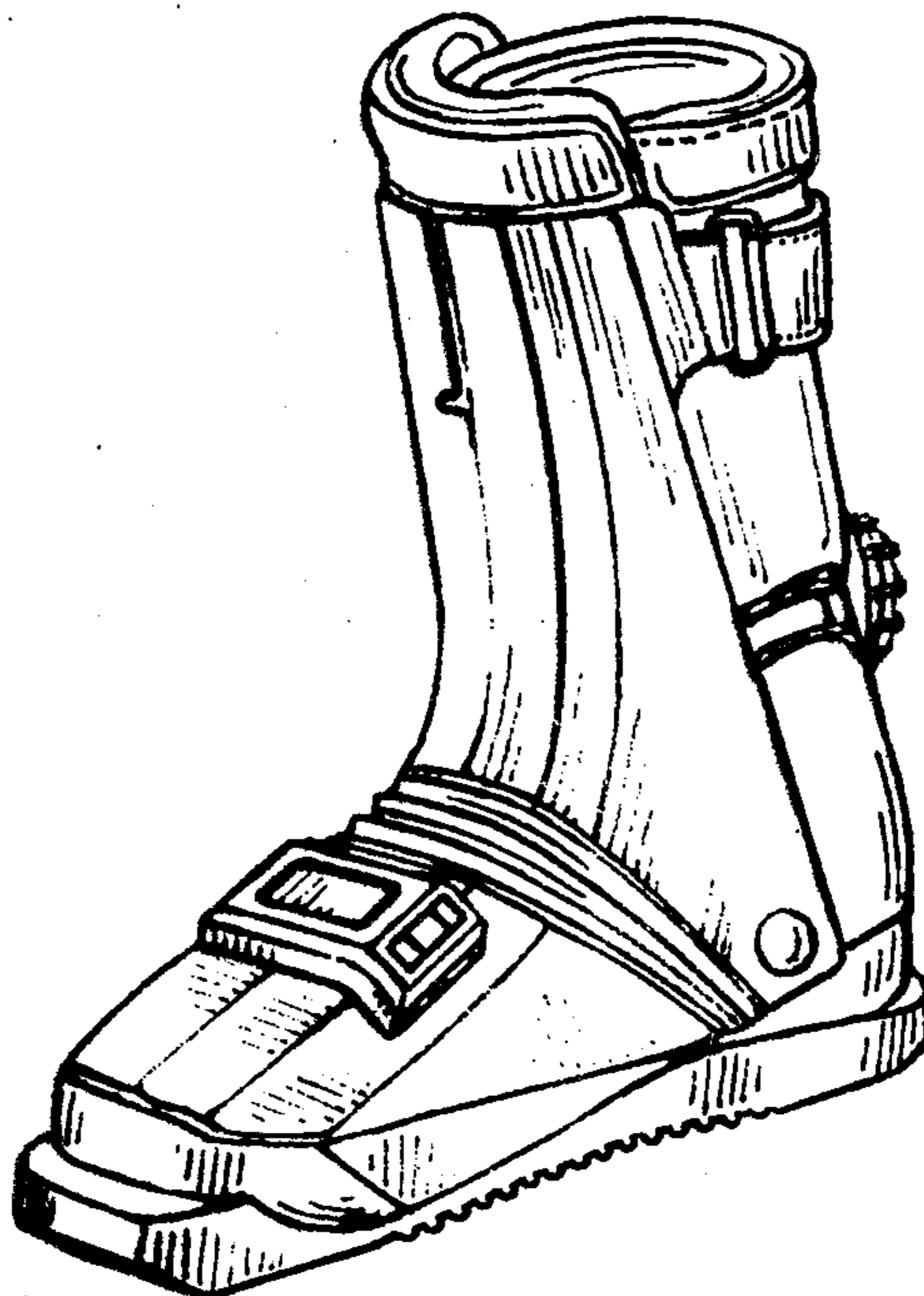

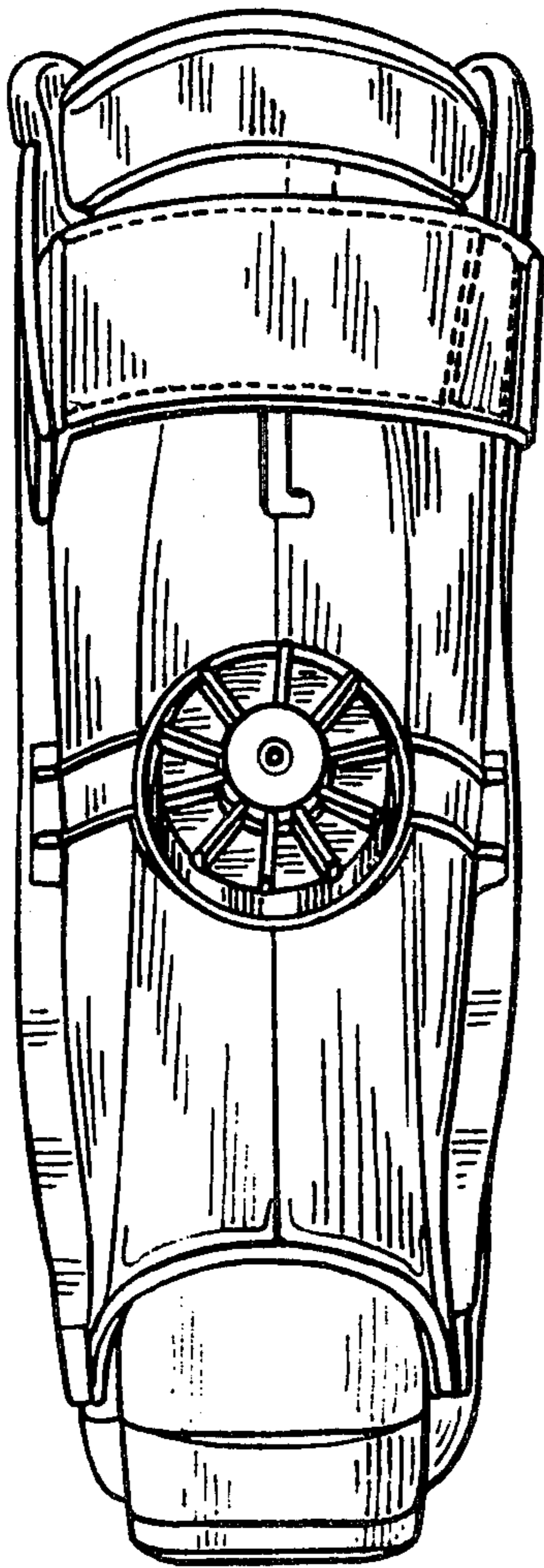

FIG. 4

FIG. 3

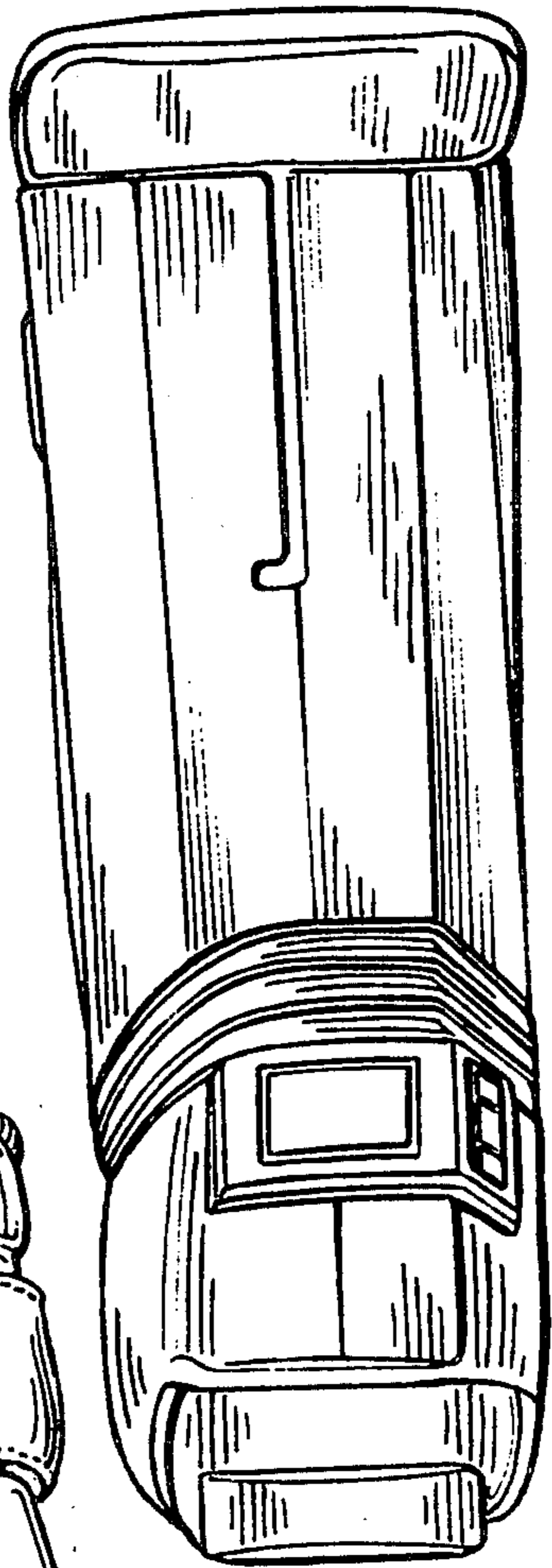
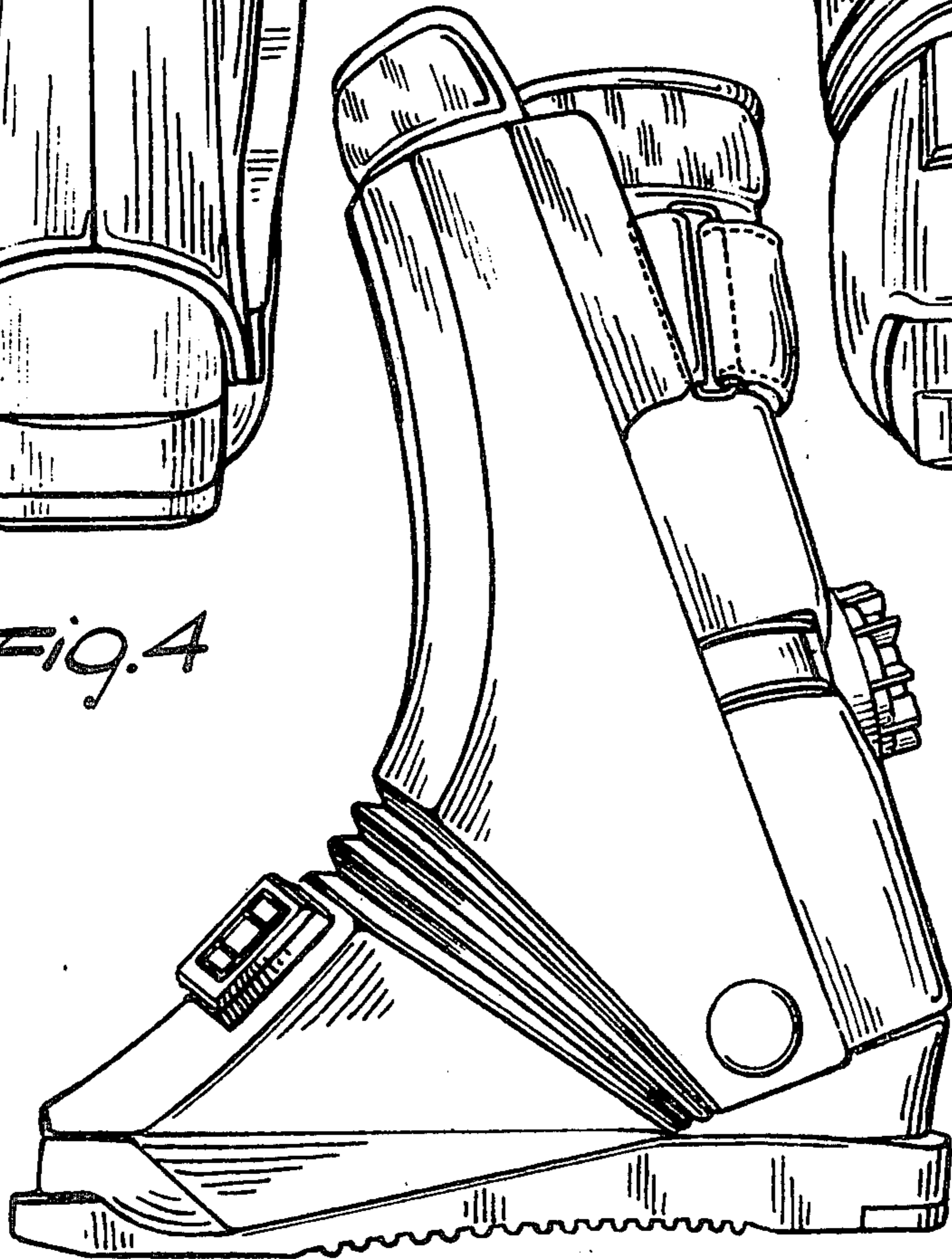

FIG. 1



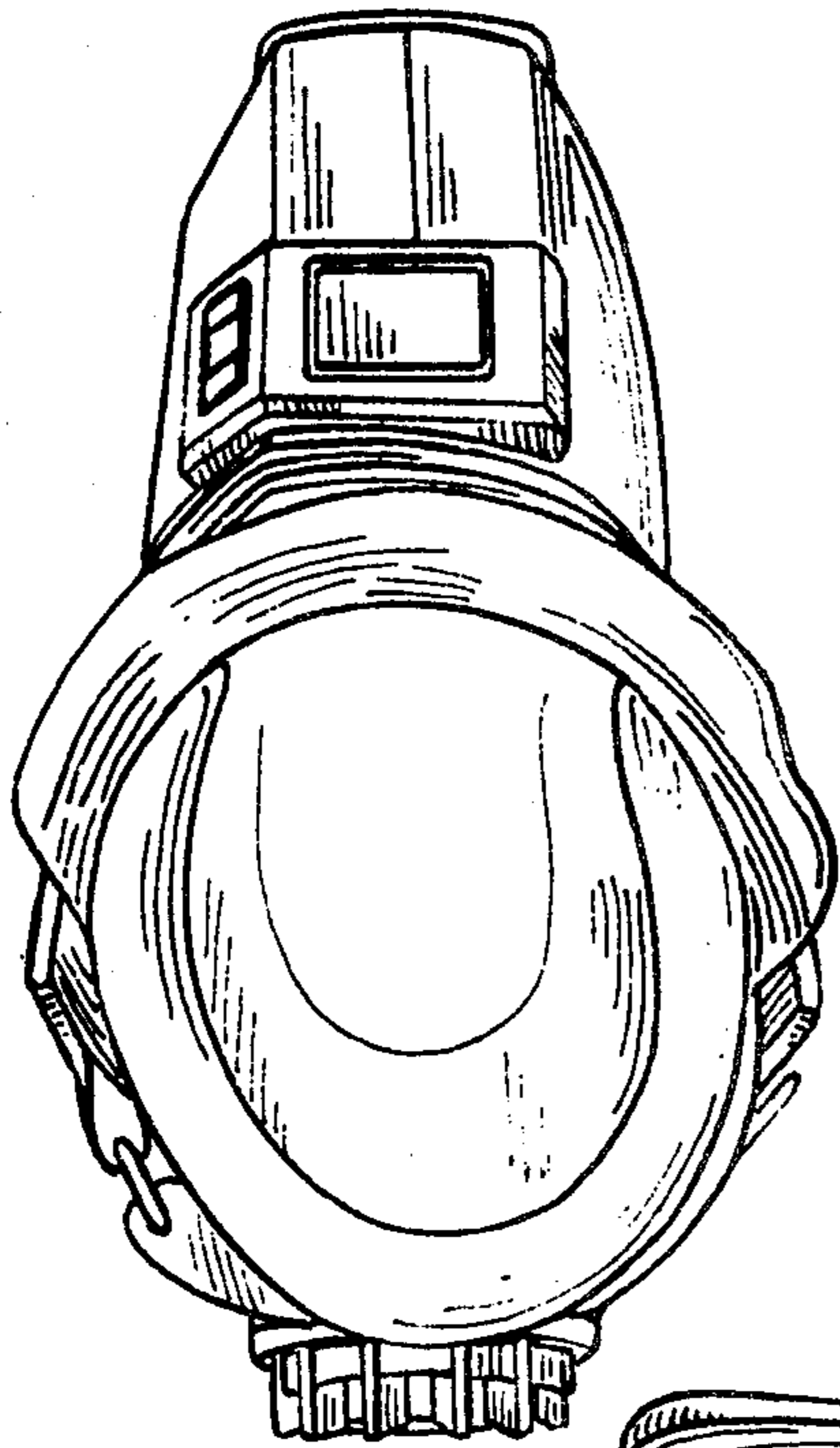

FIG. 5

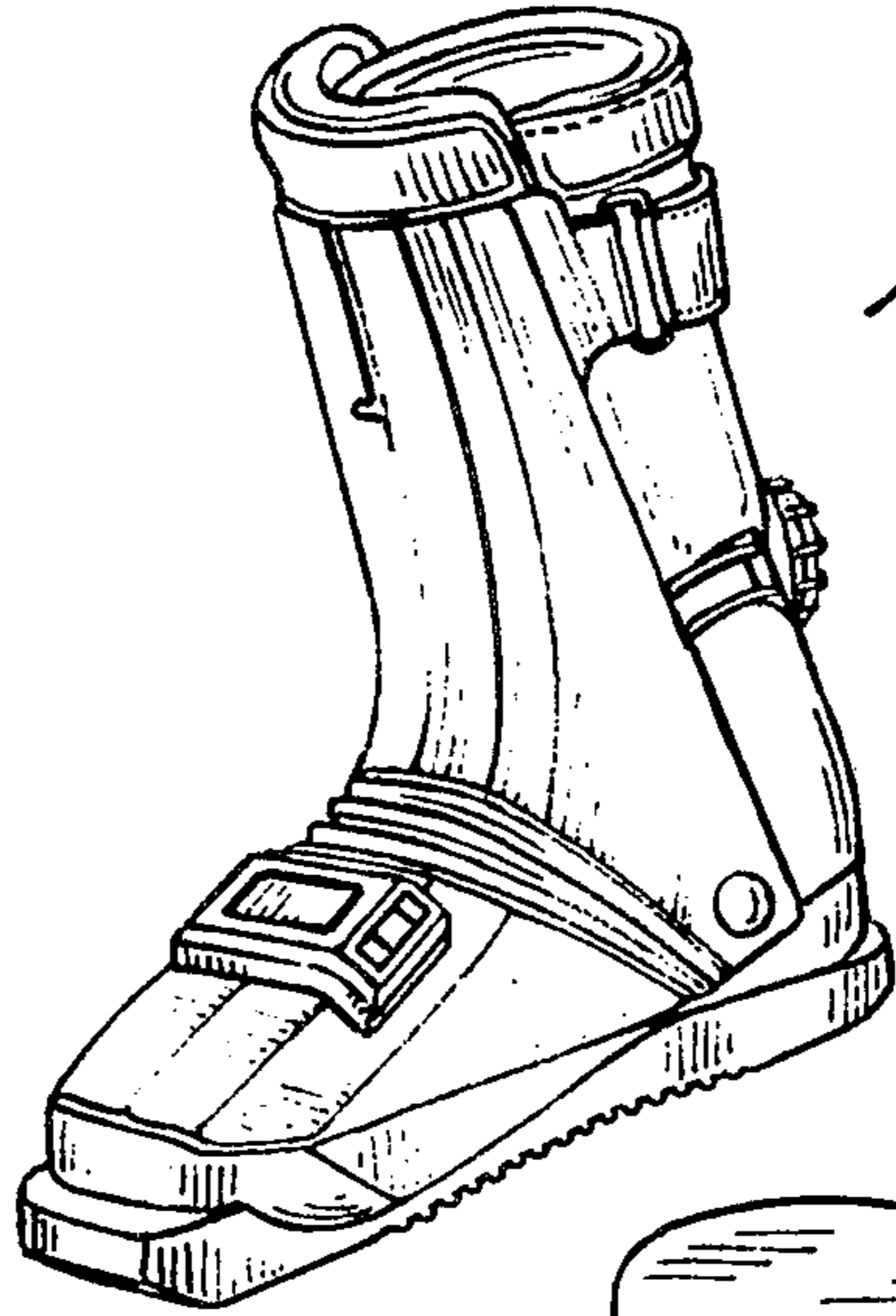

FIG. 7

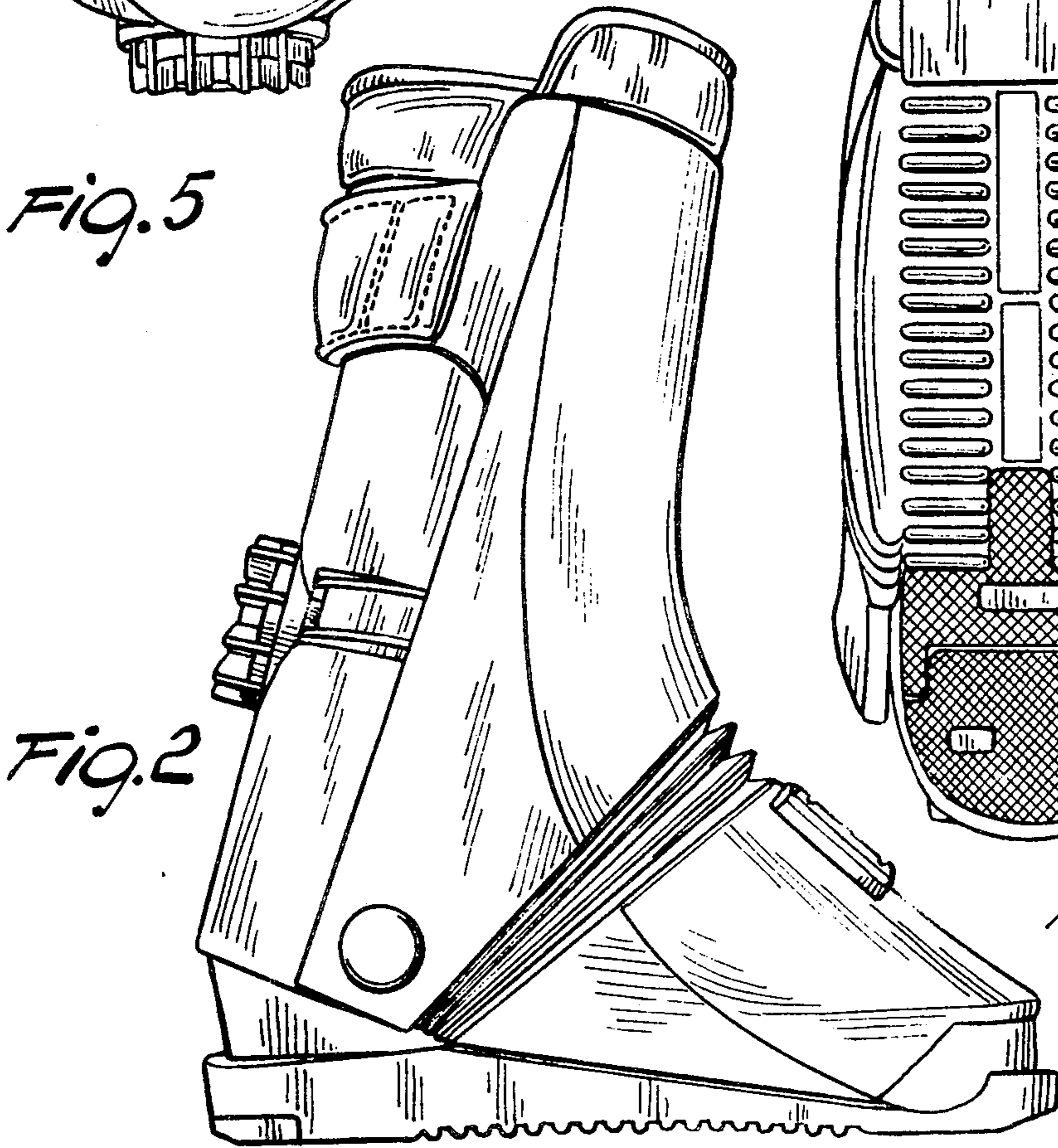

FIG. 2

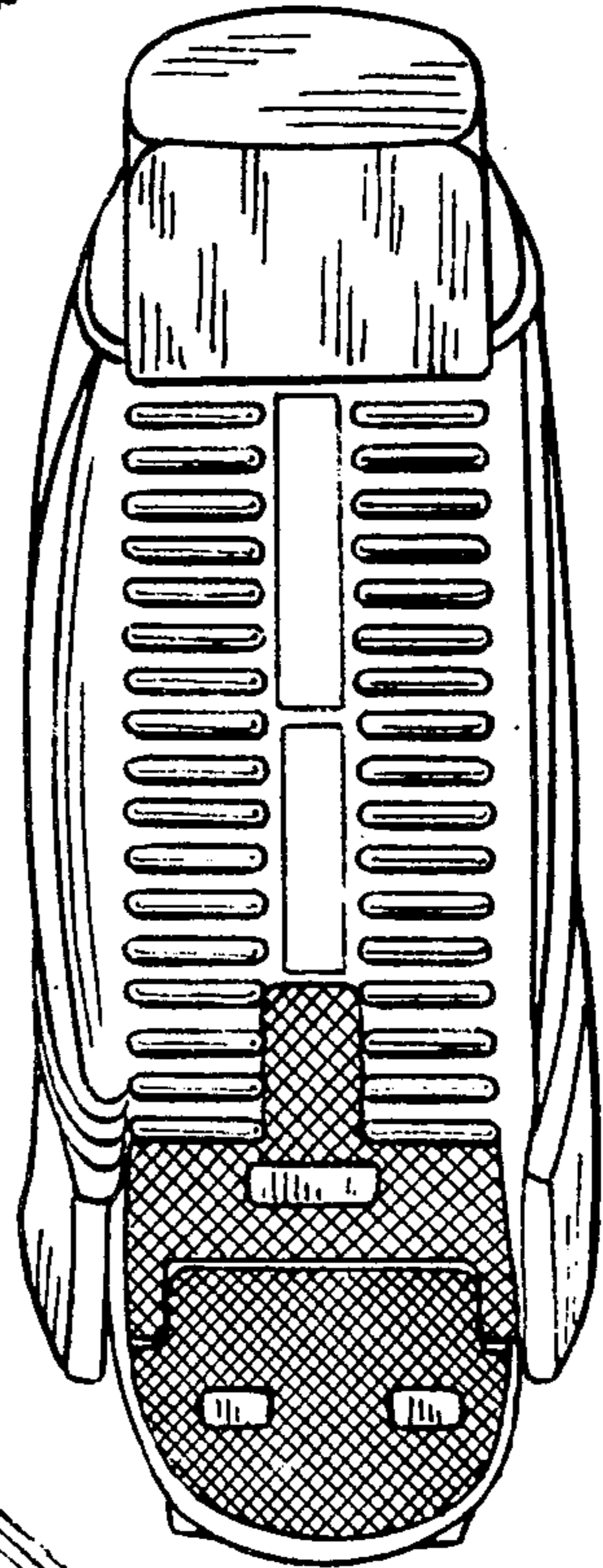

FIG. 6