

[54] PREGNANCY DIAGNOSTIC APPARATUS

[75] Inventor: David S. Byrne, Atlantic Highlands, N.J.

[73] Assignee: Warner-Lambert Company, Morris Plains, N.J.

[**] Term: 14 Years

[21] Appl. No.: 524,256

[22] Filed: Aug. 18, 1983

[52] U.S. Cl. D24/8; D9/341

[58] Field of Search 206/569, 45.34; 128/738; D9/418, 341, 455; D24/17, 99

[56] References Cited

U.S. PATENT DOCUMENTS

- D. 185,388 6/1959 Peters D24/17 X
- D. 241,173 8/1976 Corneille D24/17
- D. 241,174 8/1976 Corneille D24/17
- D. 257,227 10/1980 Youngberg D9/418

- D. 259,922 7/1981 Seki D9/418
- 3,579,306 5/1971 Crane 206/569 X
- 4,122,947 10/1978 Falla 206/569
- 4,151,833 5/1979 Polishuk 206/569 X
- 4,246,907 1/1981 Bullock 128/738

Primary Examiner—Bernard Ansher
Attorney, Agent, or Firm—Gary M. Nath; Daniel A. Scola, Jr.

[57] CLAIM

The ornamental design for a pregnancy diagnostic apparatus, as shown and described.

DESCRIPTION

- FIG. 1 is a front perspective view of a pregnancy diagnostic apparatus showing my new design;
- FIG. 2 is a front view;
- FIG. 3 is a right side view;
- FIG. 4 is a top plan view;
- FIG. 5 is a bottom plan view with enclosure;
- FIG. 6 is a bottom plan view without the enclosure.

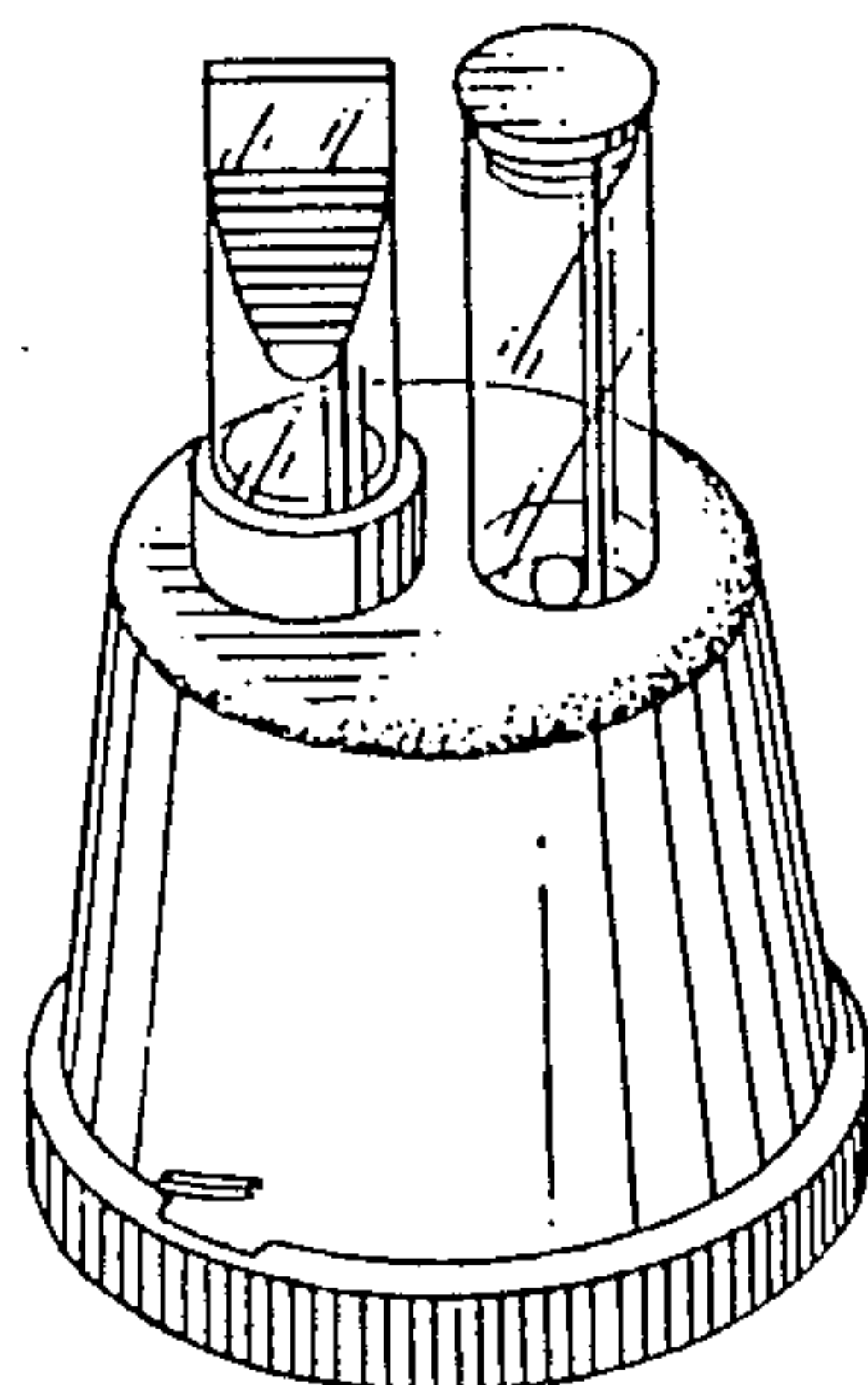
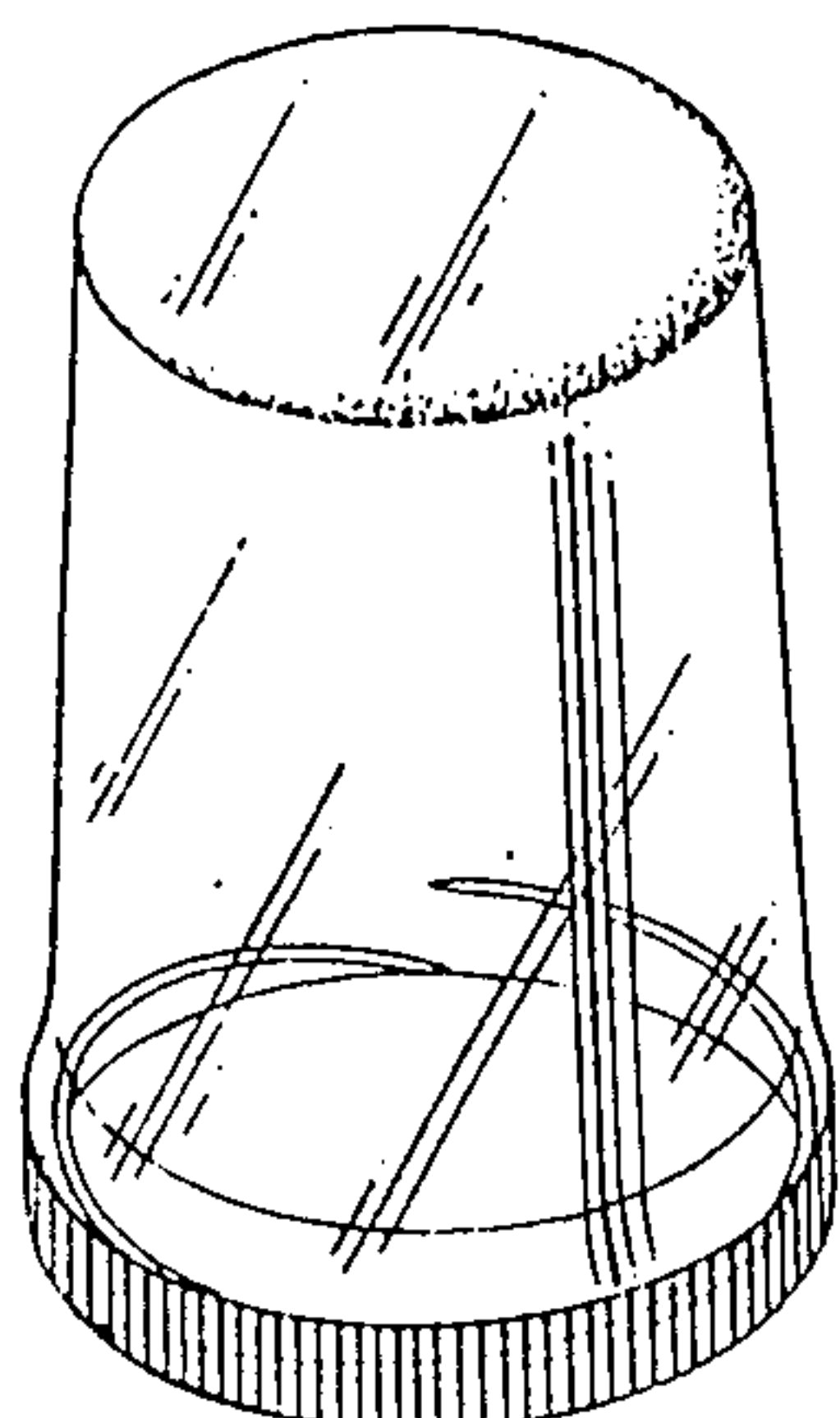

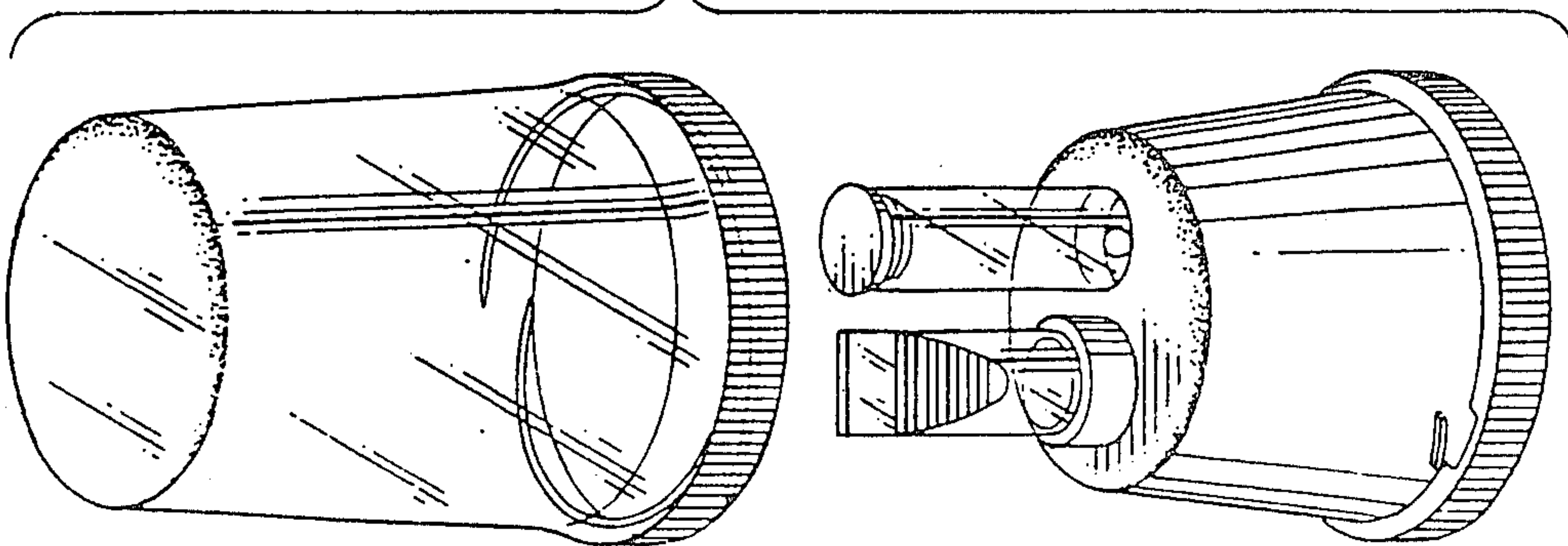

Fig. 1

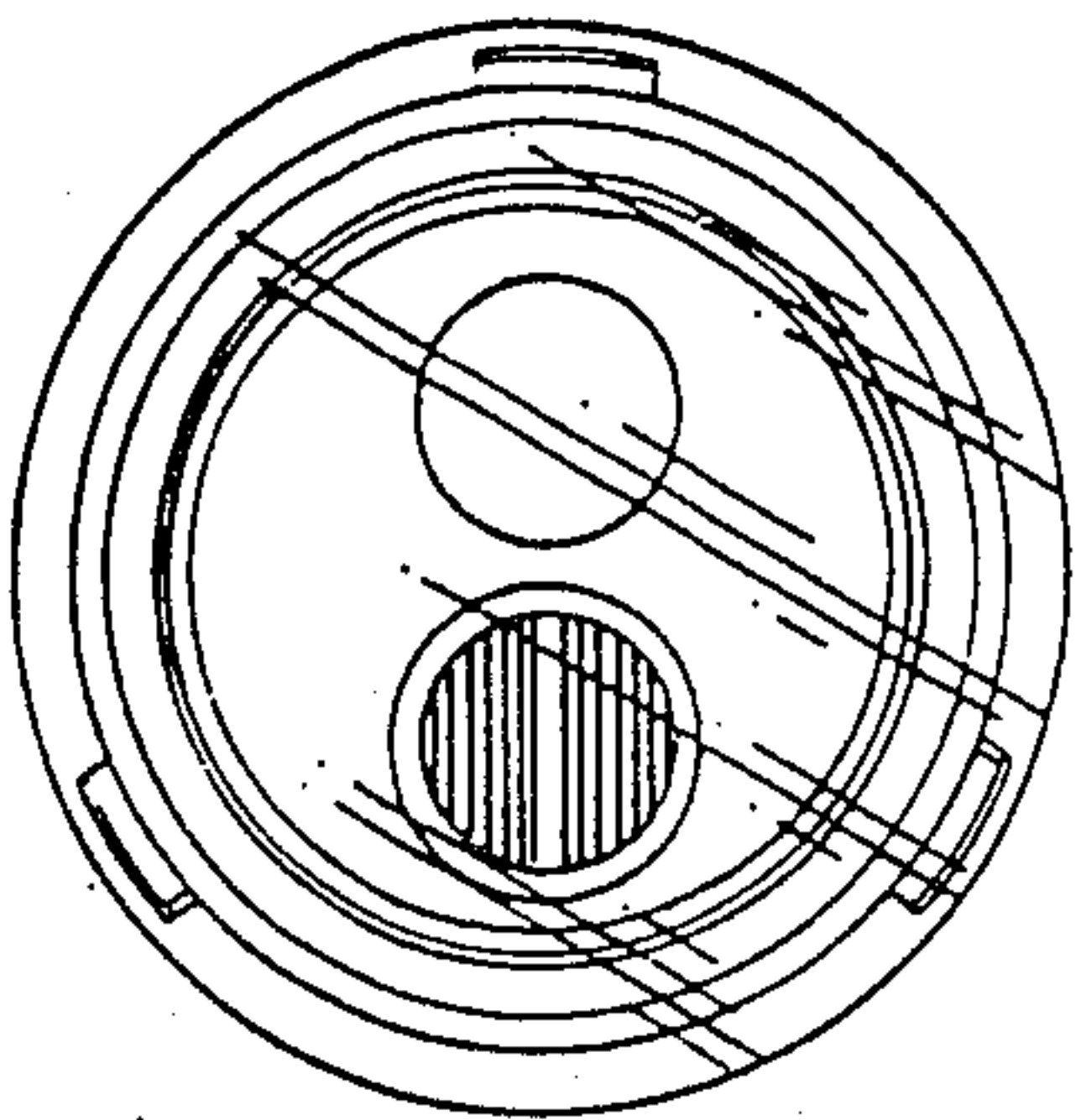

Fig. 2

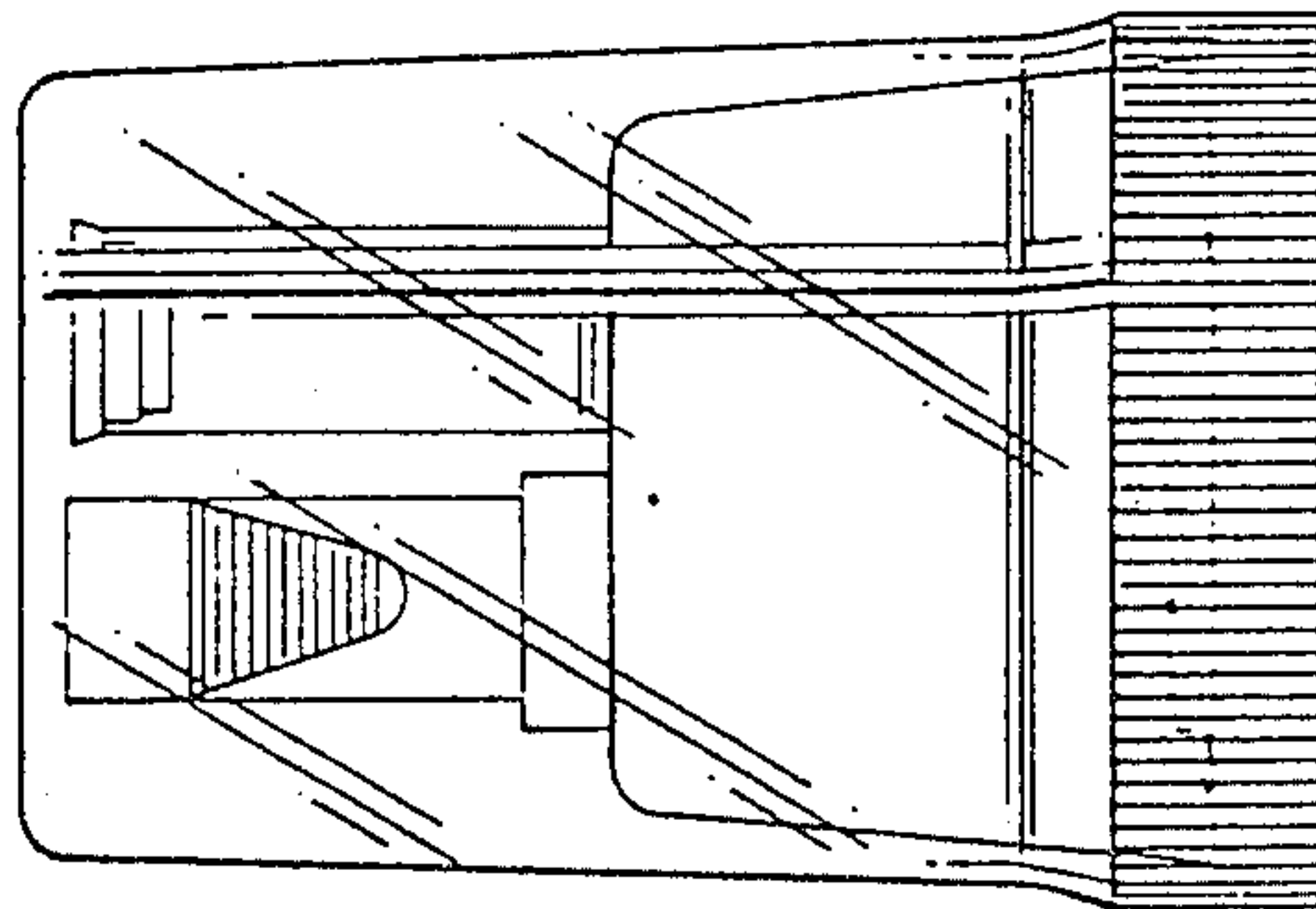

Fig. 3

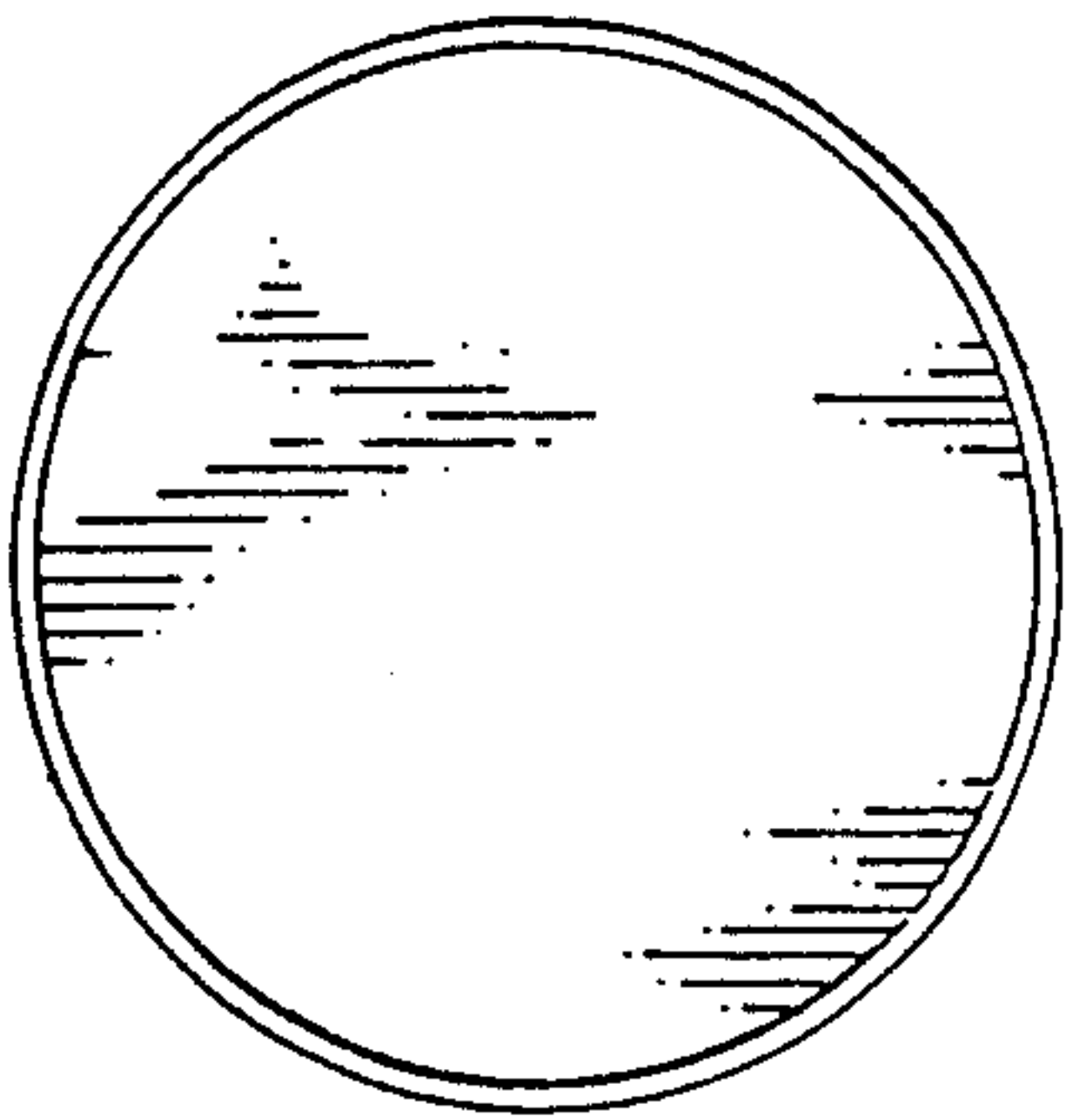

Fig. 4

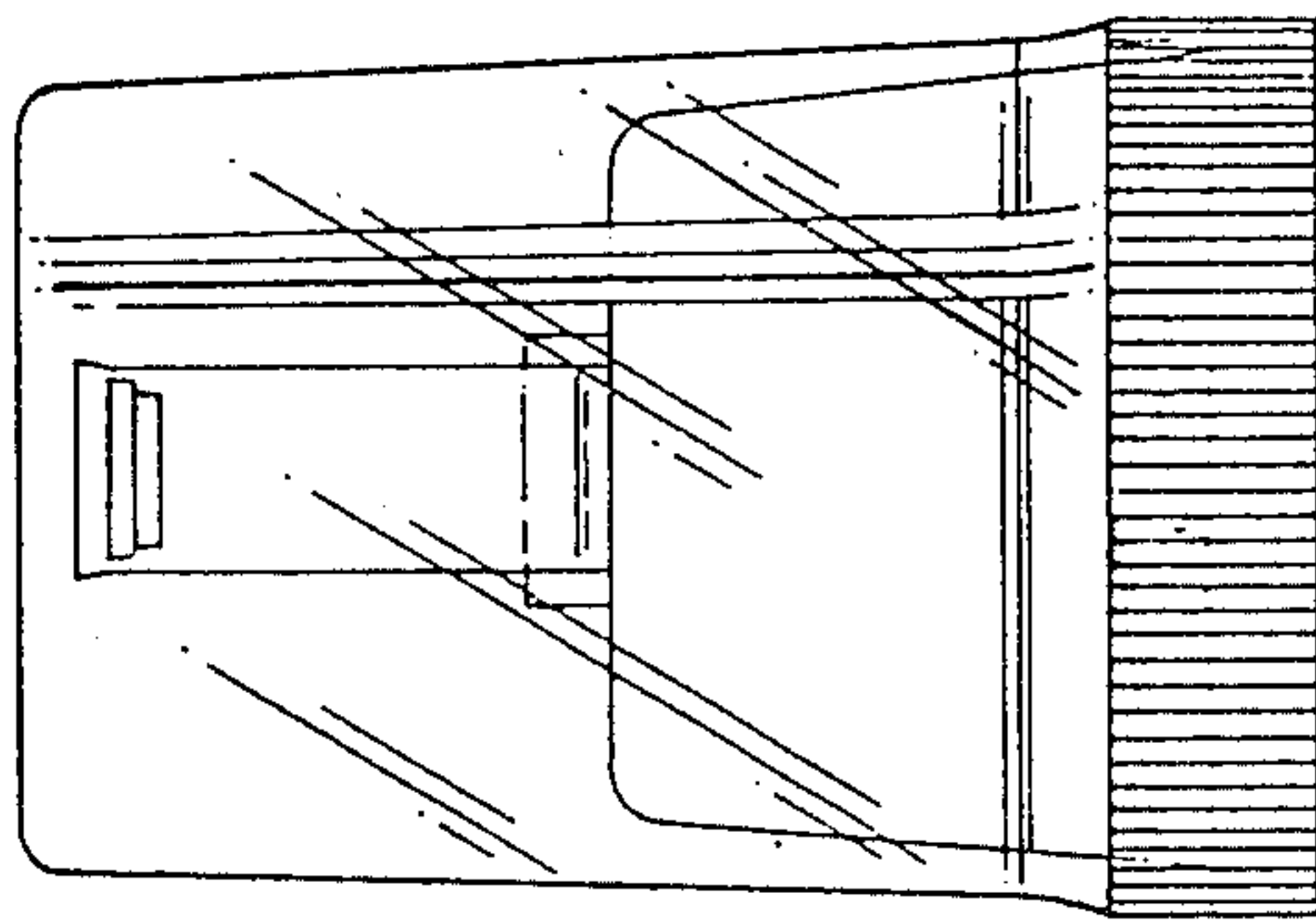

Fig. 5

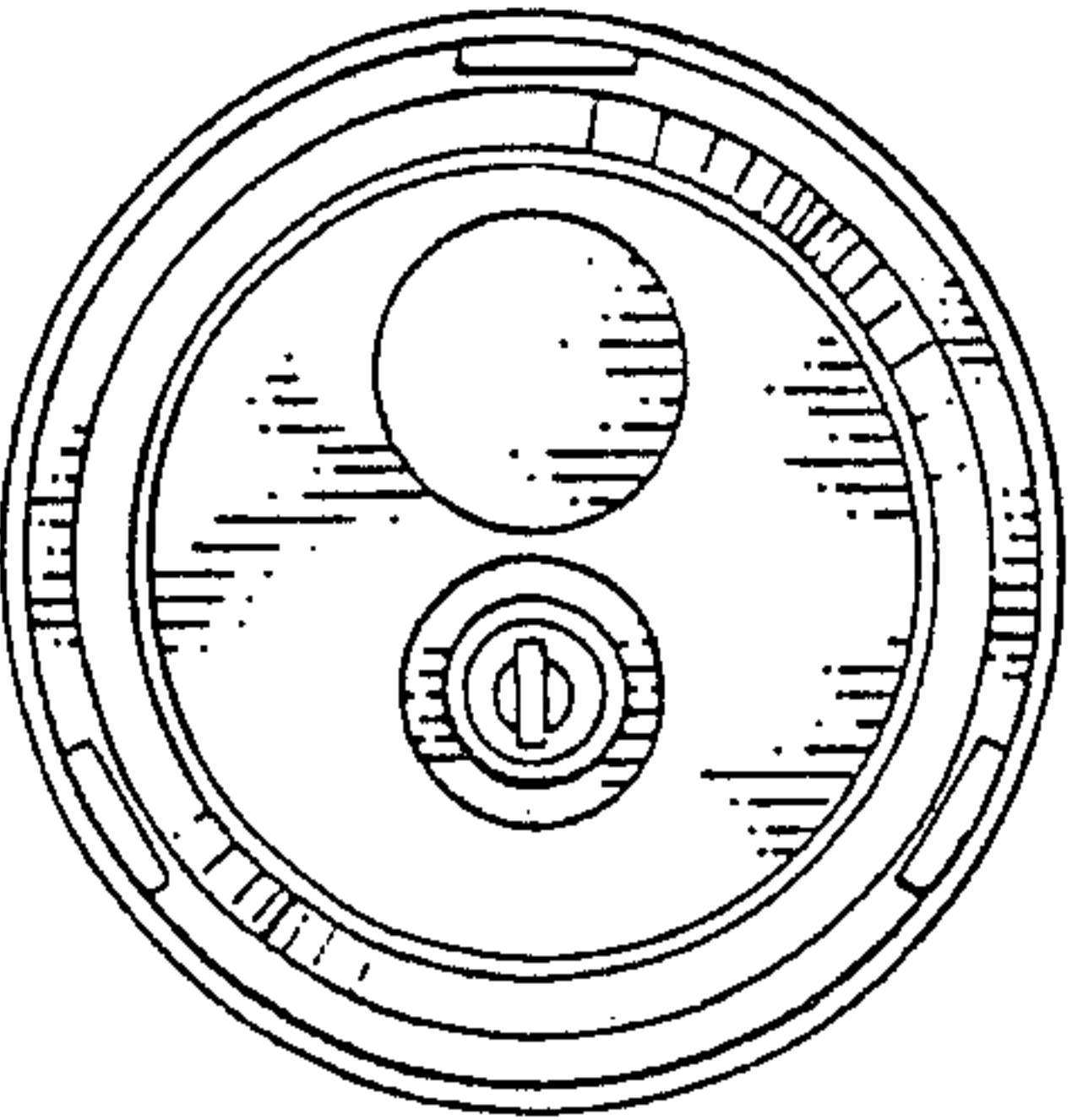

Fig. 6