

[54] SLIP-ON HEAT SINK FOR LONG INTEGRATED-CIRCUIT MODULES

[75] Inventor: Alfred F. McCarthy, Belmont, N.H.

[73] Assignee: Aavid Engineering, Inc., Laconia, N.H.

[\*\*] Term: 14 Years

[21] Appl. No.: 431,165

[22] Filed: Sep. 30, 1982

[52] U.S. Cl. .... D13/23

[58] Field of Search ..... D13/23; 174/16 HS; 357/81; 165/80, 80 A, 80 B

[56] References Cited

U.S. PATENT DOCUMENTS

- 3,548,927 12/1970 Spurling ..... 174/16 HS X
- 4,054,901 10/1977 Edwards et al. .... 174/16 HS X

Primary Examiner—Susan J. Lucas  
Attorney, Agent, or Firm—James E. Mrose

[57] CLAIM

The ornamental design for a slip-on heat sink for long integrated-circuit modules, substantially as shown and described.

DESCRIPTION

FIG. 1 is an enlarged perspective view of a slip-on heat sink for long integrated circuit module showing my new design, the module being shown in broken lines for illustrative purposes only;

FIG. 2 is a front elevational view thereof;

FIG. 3 is a top plan view thereof;

FIG. 4 is a bottom plan view thereof;

FIG. 5 is a rear elevational view thereof;

FIG. 6 is a right side elevational view thereof;

FIG. 7 is a left side elevational view thereof.

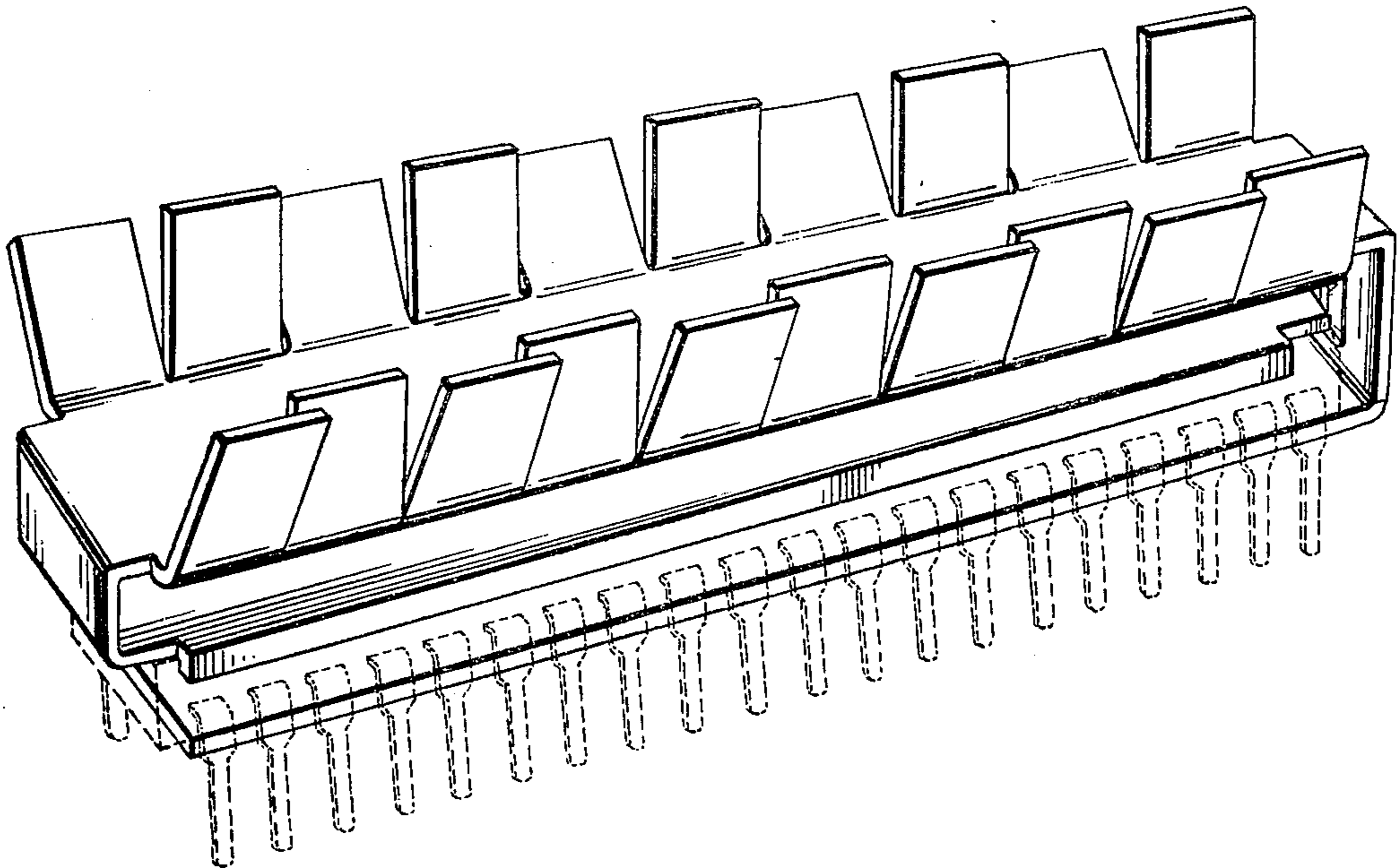

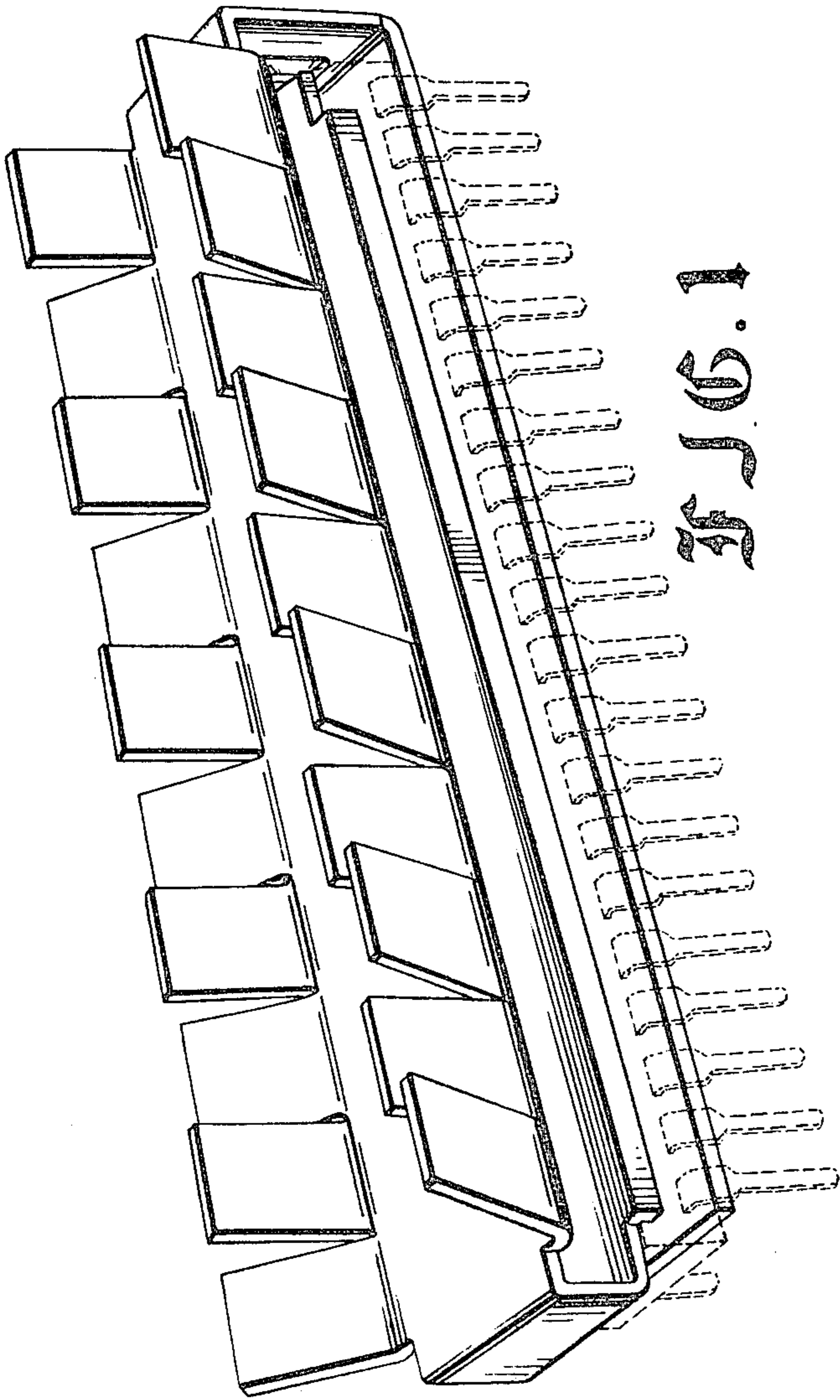

FIG. 1

FIG. 3

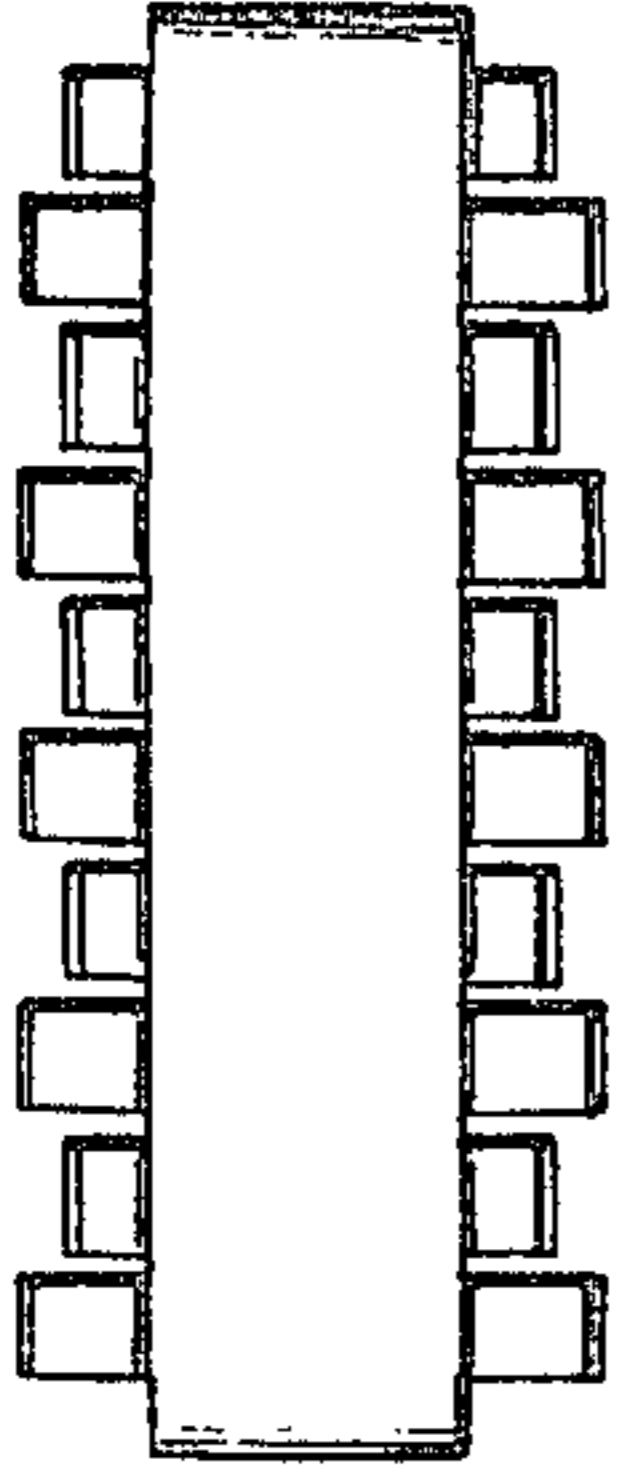

FIG. 4

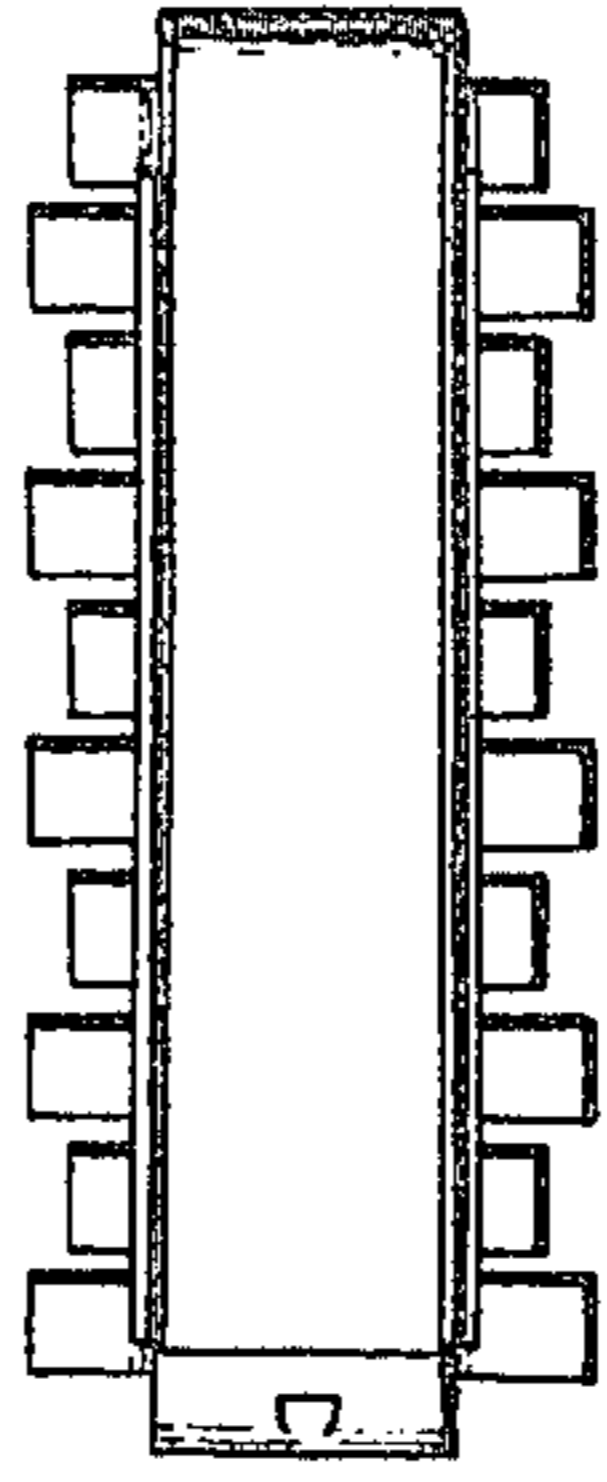

FIG. 6

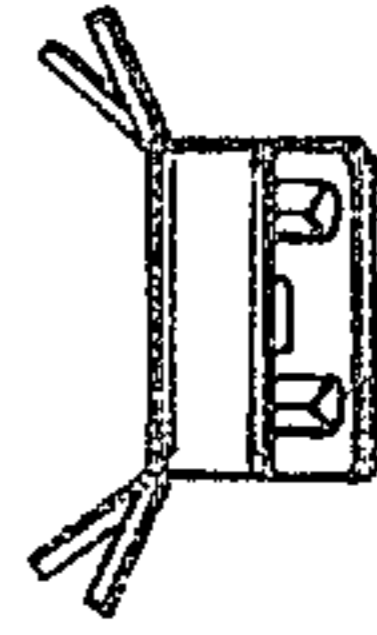
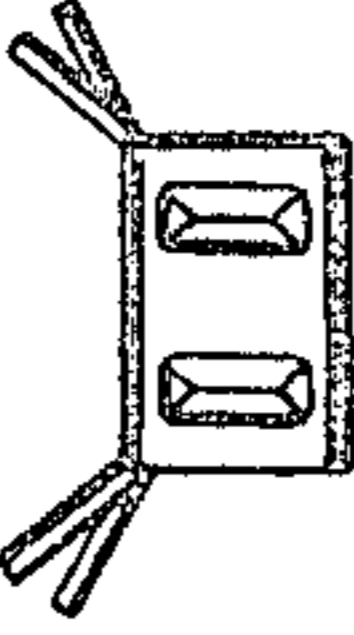

FIG. 7

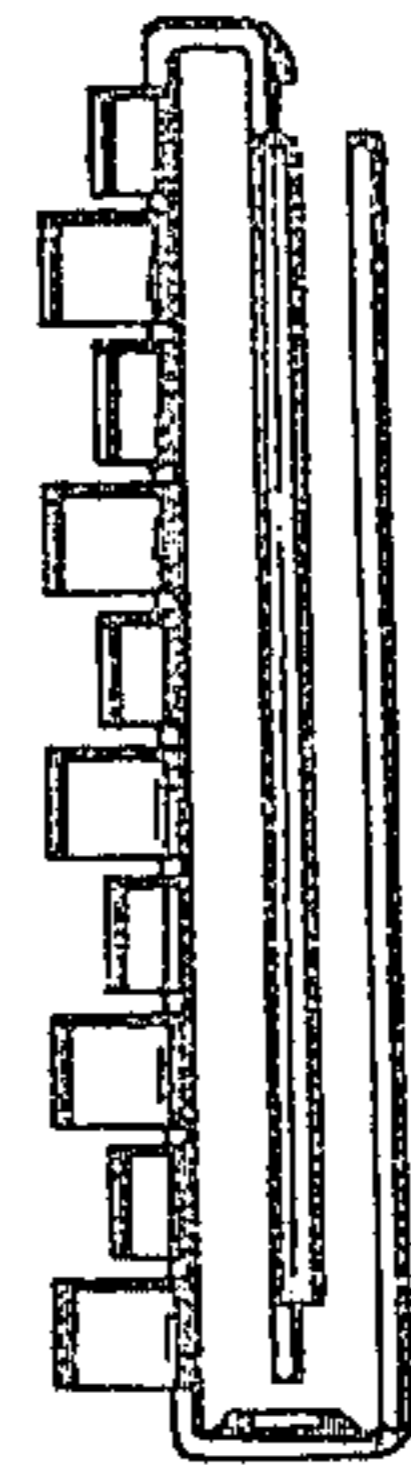

FIG. 5



FIG. 2