

[54] JEWELRY CONTAINER

[75] Inventor: Gordon S. Duckworth, Swallowhurst, England

[73] Assignee: Prestons Ltd., Lancashire, England

[**] Term: 14 Years

[21] Appl. No.: 340,039

[22] Filed: Jan. 18, 1982

Related U.S. Application Data

[62] Division of Ser. No. 96,814, Nov. 23, 1979, abandoned.

[30] Foreign Application Priority Data

Jun. 27, 1979	[GB]	United Kingdom	79990532
Jun. 27, 1979	[GB]	United Kingdom	79990533
Jun. 27, 1979	[GB]	United Kingdom	79990534
Jun. 27, 1979	[GB]	United Kingdom	79990535

[52] U.S. Cl. D3/75; D3/66

[58] Field of Search D19/26-28; D3/33, 35, 44, 65, 66, 74, 75; D9/326; 206/387, 45.13, 45.15, 45.23, 303

[56] References Cited

U.S. PATENT DOCUMENTS

1,043,560 11/1912 Anthony D3/74

1,646,632	10/1927	Spinner	D3/66
1,709,685	4/1929	Rothrock	D9/326
1,960,073	5/1934	Warner	D3/66
3,003,619	10/1961	Samuels	206/45.13

OTHER PUBLICATIONS

Jewelers Circular Keystone Directory Issue 1971-72, p. 66, Item No. 33.

Primary Examiner—George P. Word
Attorney, Agent, or Firm—Alan Ruderman

[57] CLAIM

The ornamental design for a jewelry container, as shown and described.

DESCRIPTION

FIG. 1 is a perspective view of a jewelry container showing my new design in the open condition;
 FIG. 2 is a plan view thereof;
 FIG. 3 is a cross-sectional view taken along line 3—3 of FIG. 2;
 FIG. 4 is a perspective view of a modified form of the jewelry container in the open condition;
 FIG. 5 is a plan view thereof;
 FIG. 6 is a cross-sectional view taken along line 6—6 of FIG. 5;
 FIG. 7 is a front perspective view of the exterior of the jewelry container in a partially open condition; and
 FIG. 8 is an inverted rear perspective view thereof.

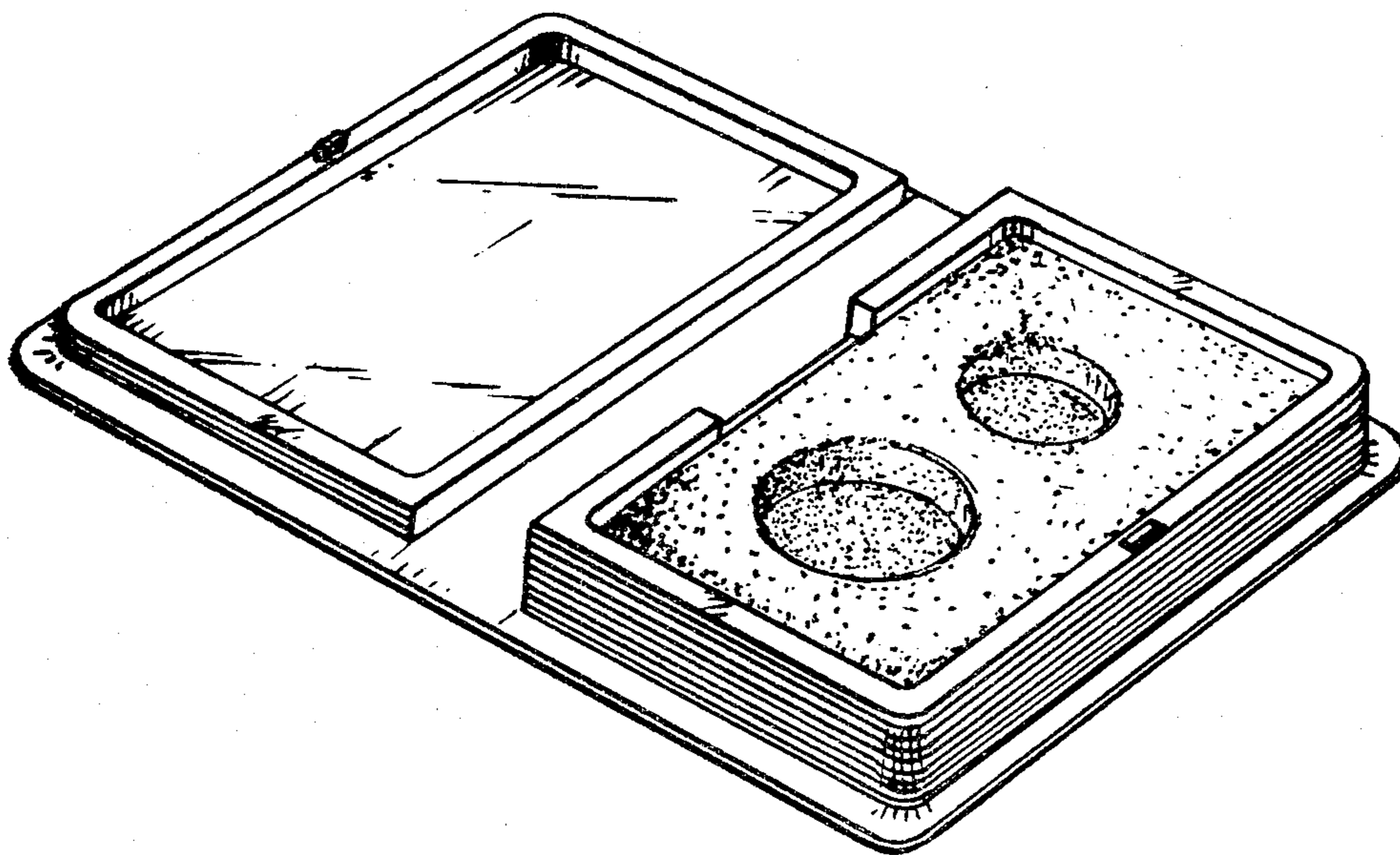

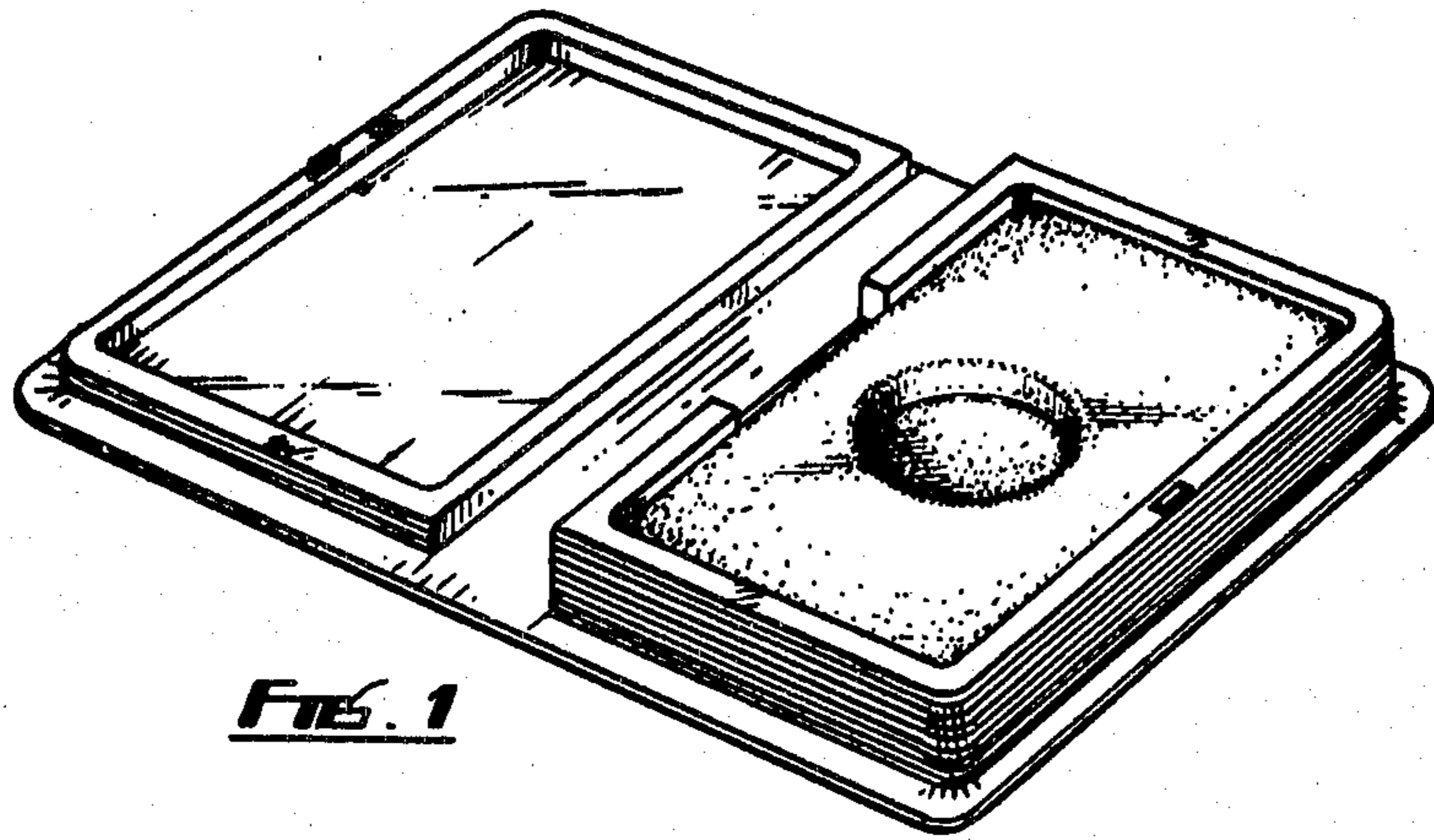

FIG. 1

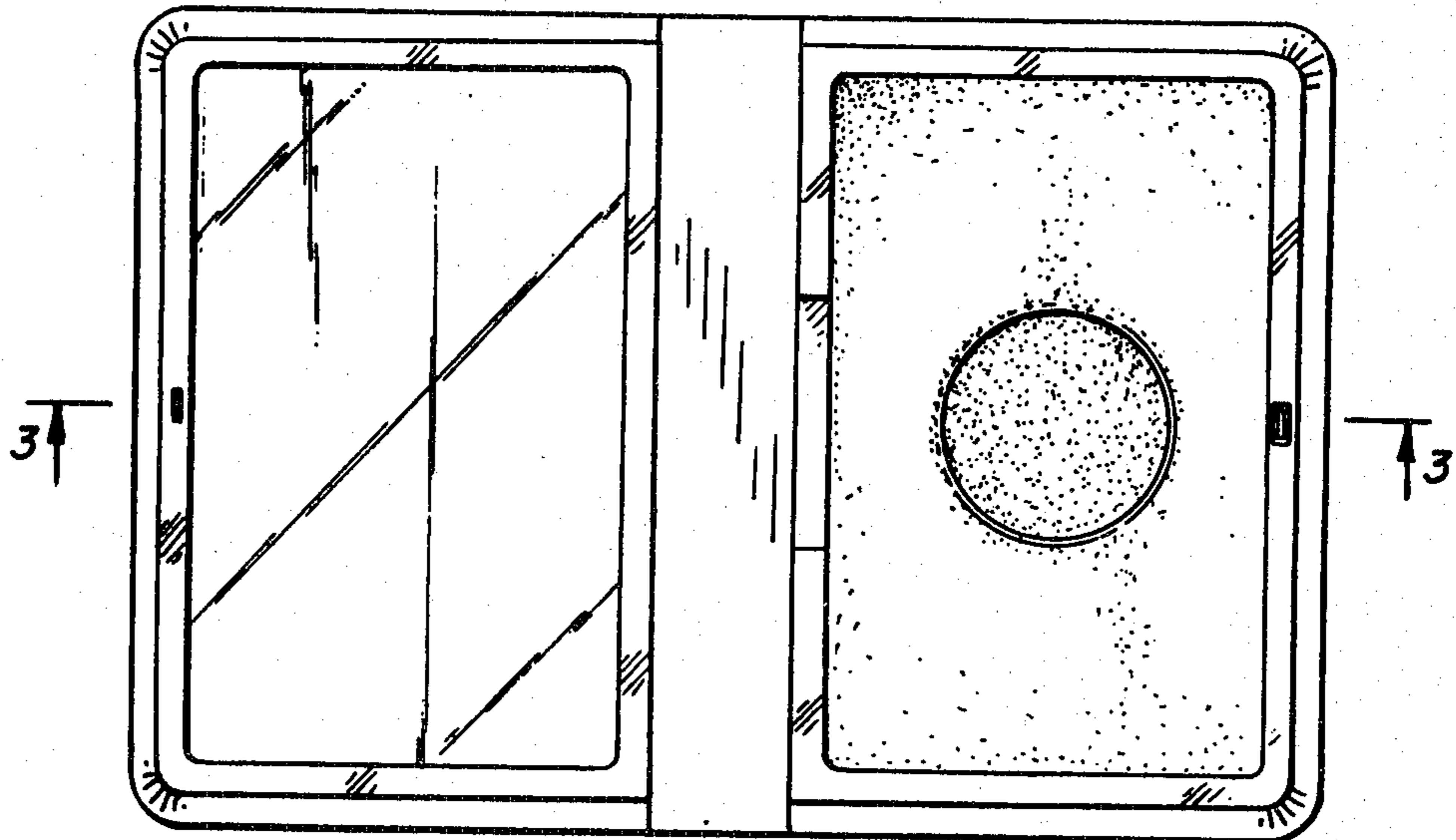

FIG. 2

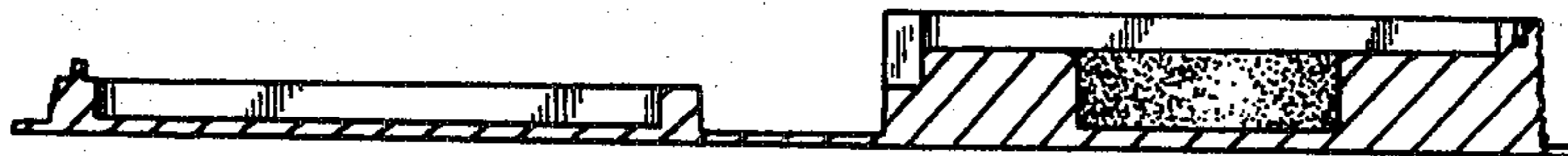

FIG. 3

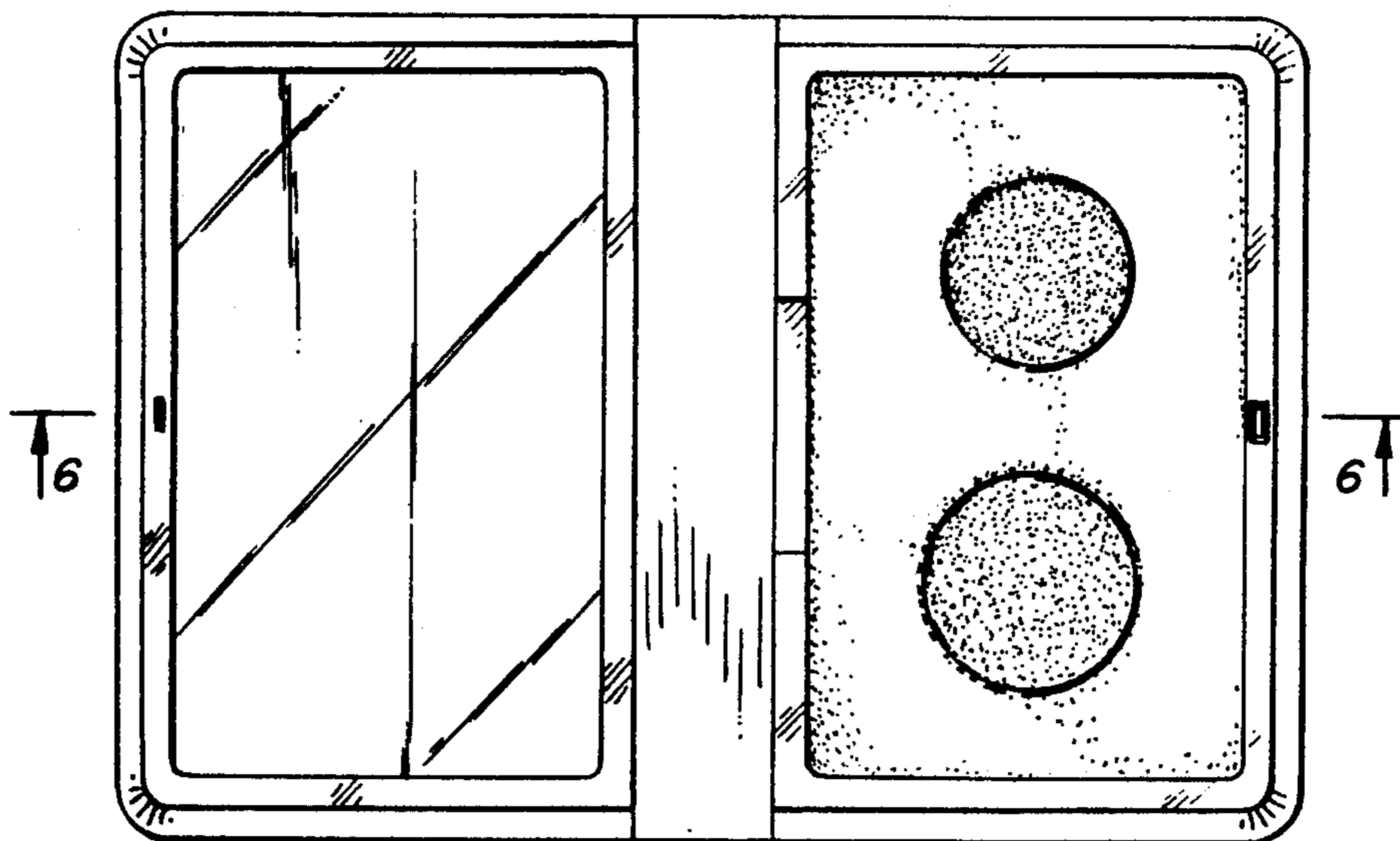
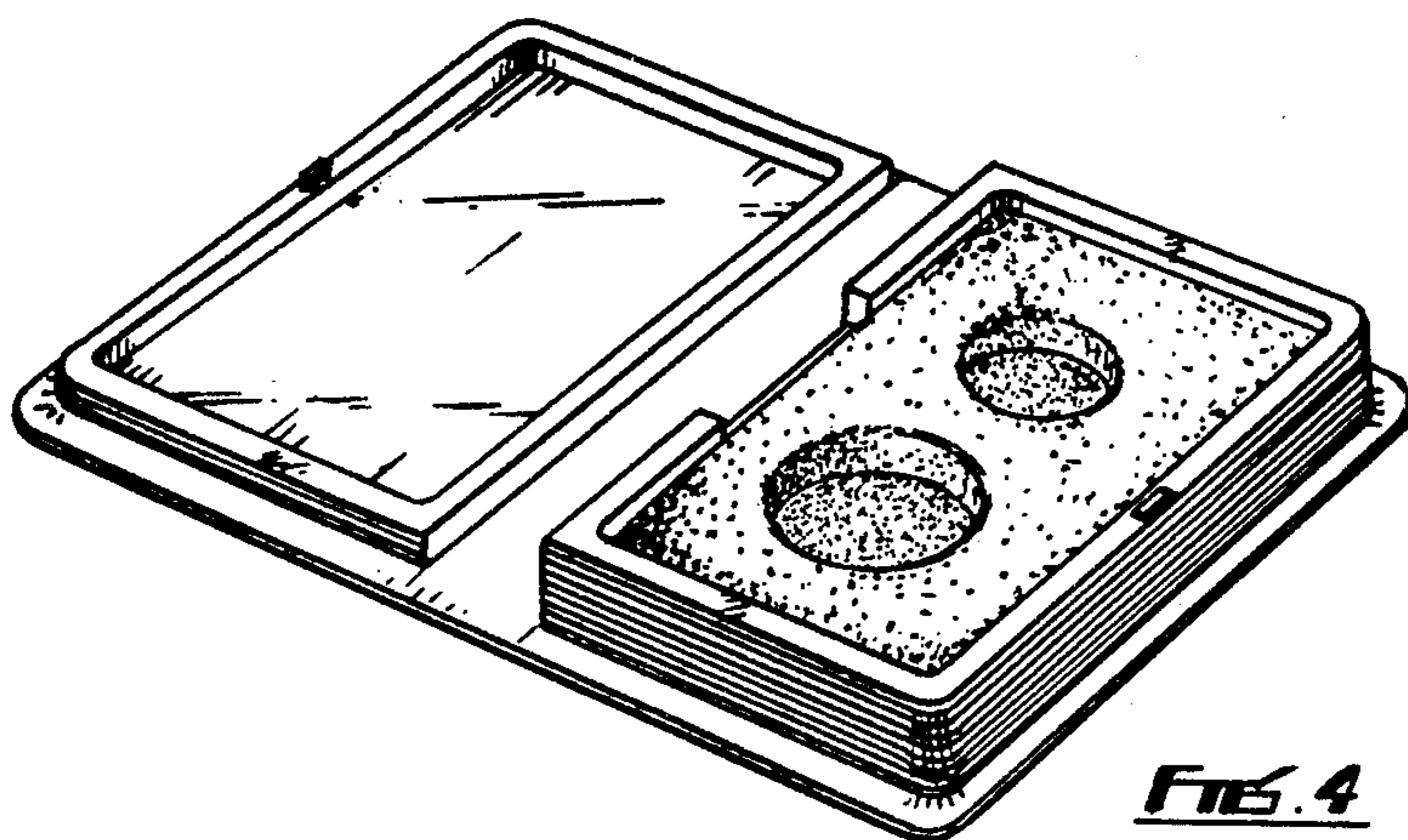

FIG. 7

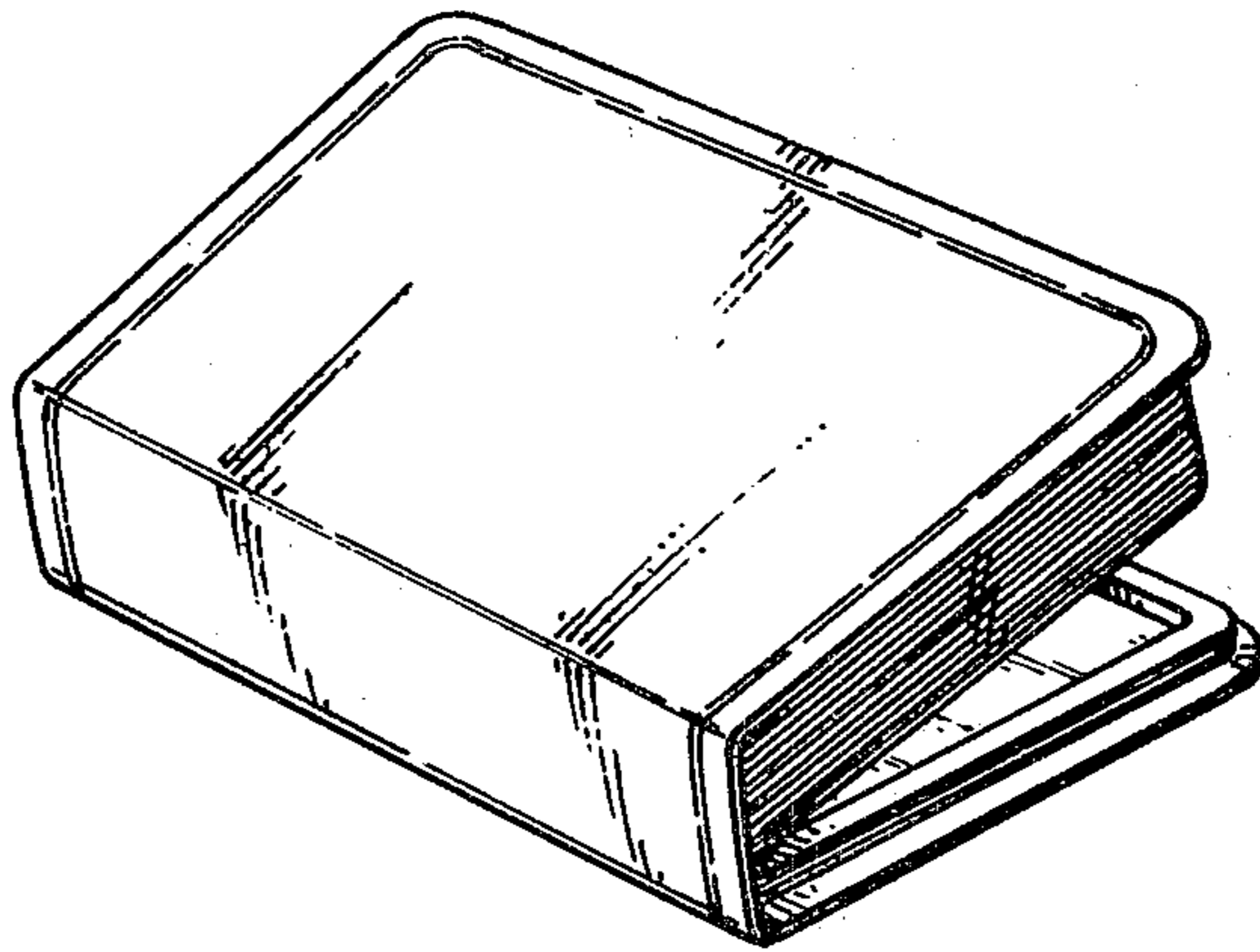
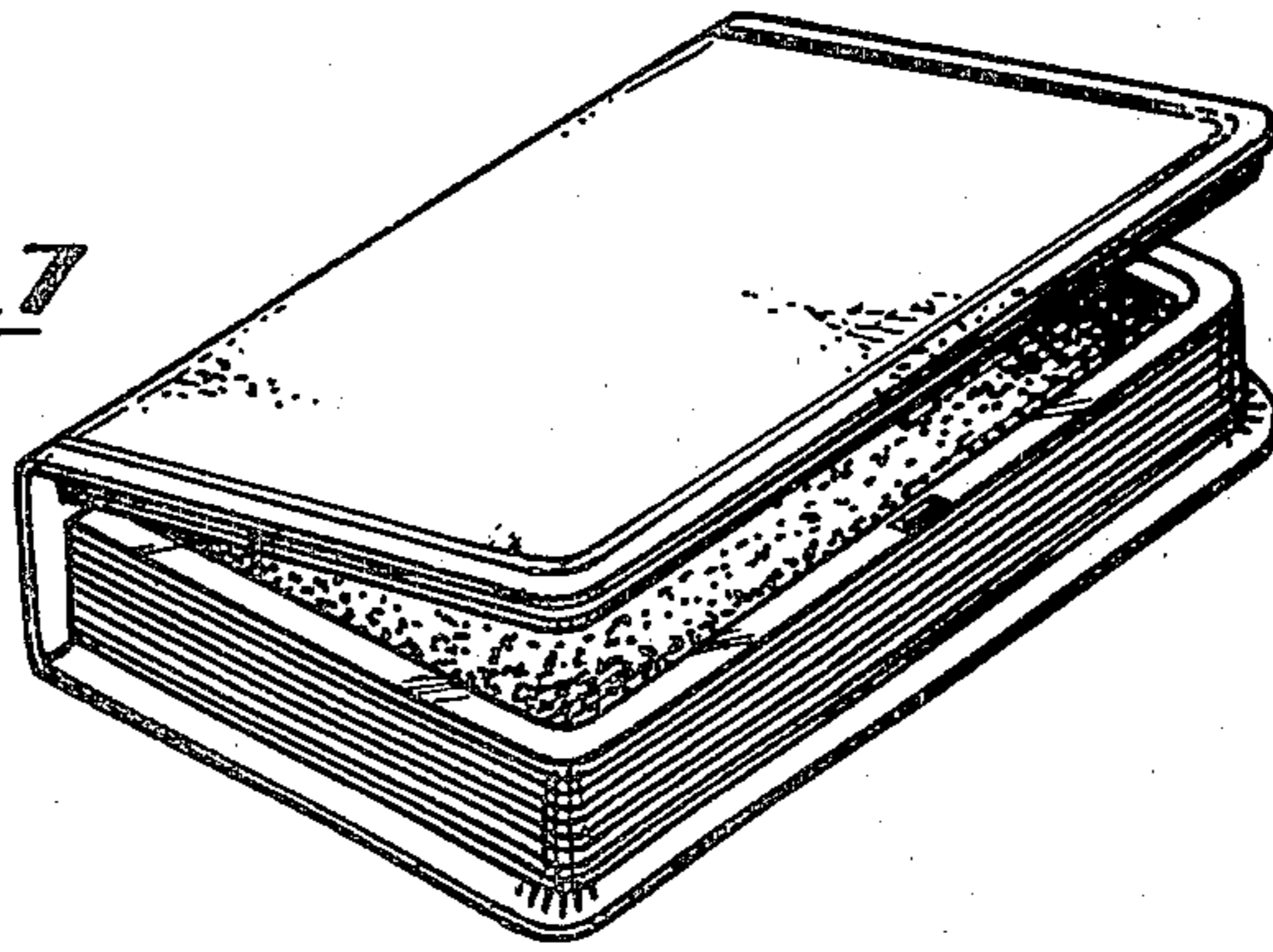

FIG. 8