

[54] TRAVEL IRON

[75] Inventors: Davin Stowell; Tucker Viemeister, both of New York; John Lonczak, Scarsdale, all of N.Y.

[73] Assignee: Sanyei Corporation, Japan

[\*\*] Term: 14 Years

[21] Appl. No.: 420,402

[22] Filed: Sep. 20, 1982

[52] U.S. Cl. .... D32/70

[58] Field of Search ..... 38/74-77.9, 38/82, 88, 90, 93; D32/68-73

[56] References Cited

U.S. PATENT DOCUMENTS

D. 216,153	11/1969	Tsunoda	.....	D32/70
D. 240,997	8/1976	Fulkenbeck	.....	D32/70
2,769,257	11/1956	Duncanson et al.	.....	D32/70 X
3,184,871	5/1965	D'Alessandro	.....	38/77.8
3,229,392	1/1966	Camilleri	.....	38/90
3,672,080	6/1972	Murphy et al.	.....	38/90

OTHER PUBLICATIONS

Sanyo Brochure-Portable Iron, printed Jul. 1981.  
W. Bell and Co. Catalog-1981, p. 316, G.E. Travel Iron.

Primary Examiner—Catherine E. Kemper  
Attorney, Agent, or Firm—Ostrolenk, Faber, Gerb & Soffen

[57] CLAIM

The ornamental design for a travel iron, as shown and described.

DESCRIPTION

FIG. 1 is a left-side perspective view of a travel iron in the assembled state showing our new design;  
FIG. 2 is a front view thereof;  
FIG. 3 is a rear view thereof;  
FIG. 4 is a top view thereof;  
FIG. 5 is a bottom view thereof;  
FIG. 6 is a left-side view thereof;  
FIG. 7 is a right-side view thereof;  
FIG. 8 is a plan view thereof in the storage state;  
FIG. 9 is a right-side view thereof;  
FIG. 10 is a left-side view thereof;  
FIG. 11 is a front view thereof;  
FIG. 12 is a rear view thereof;  
FIG. 13 is a right-side view of the handle thereof;  
FIG. 14 is a left-side view thereof;  
FIG. 15 is a top view thereof;  
FIG. 16 is a bottom view thereof;  
FIG. 17 is a rear view thereof; and  
FIG. 18 is a front view thereof.

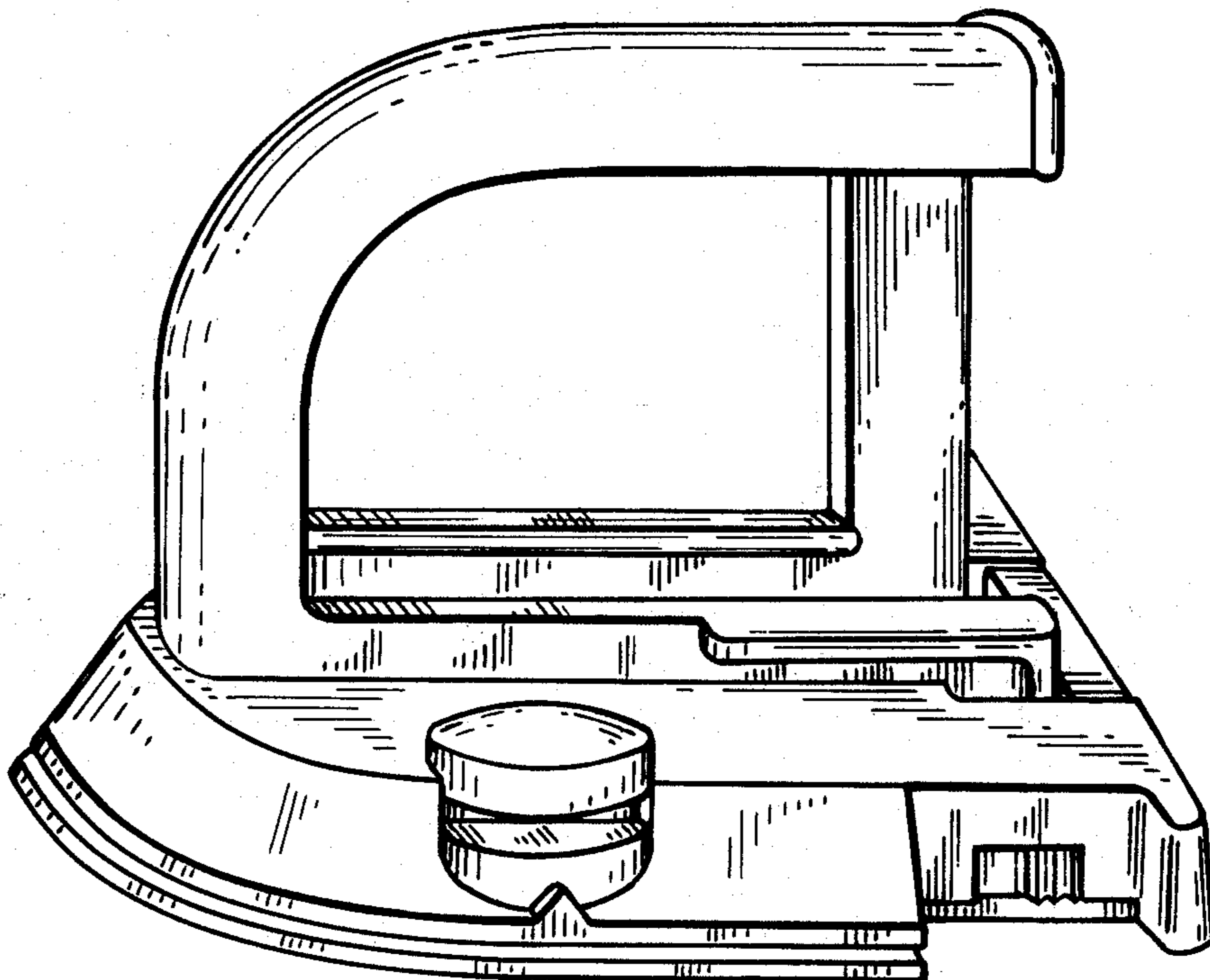

FIG. 1.

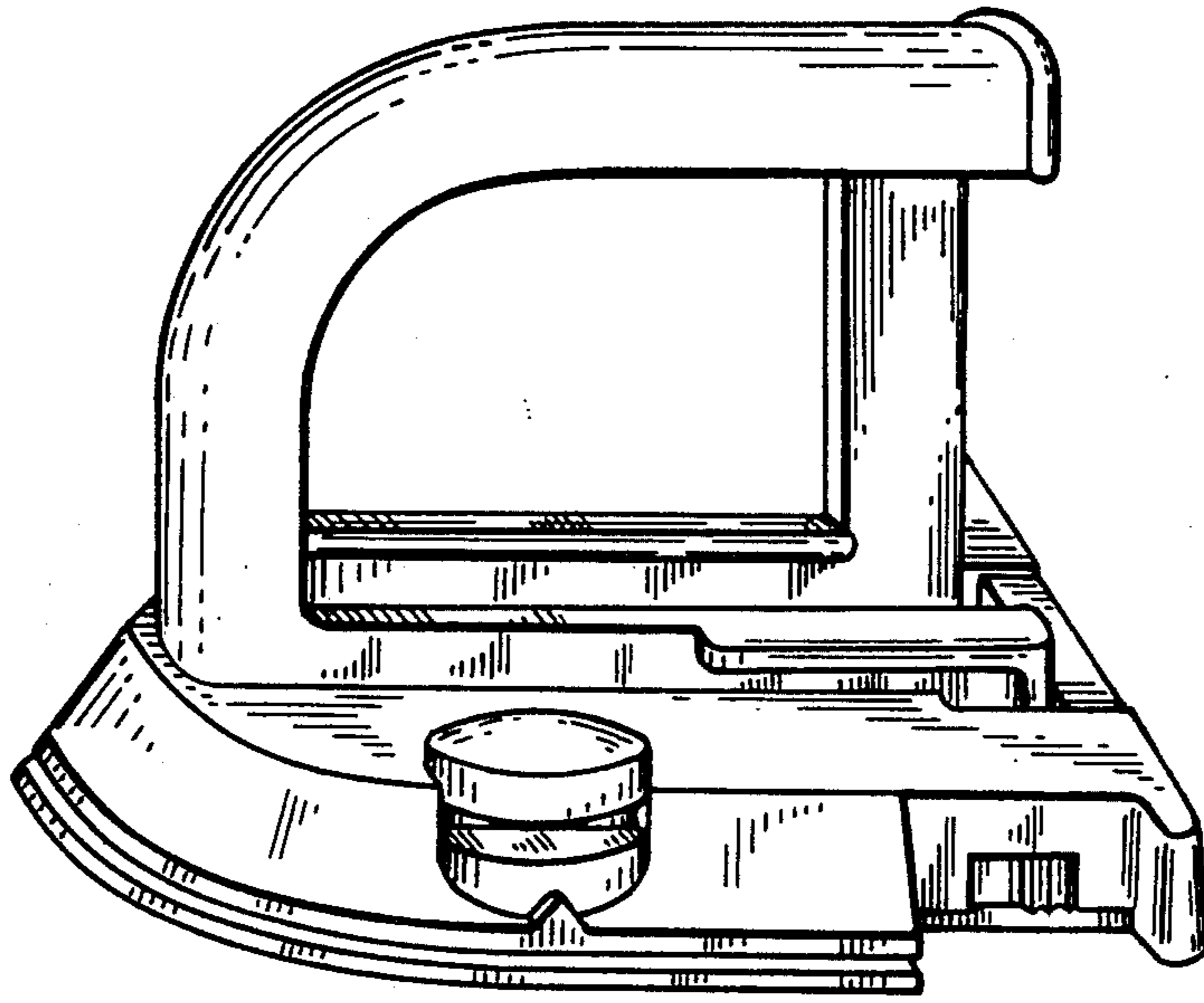

FIG. 2.

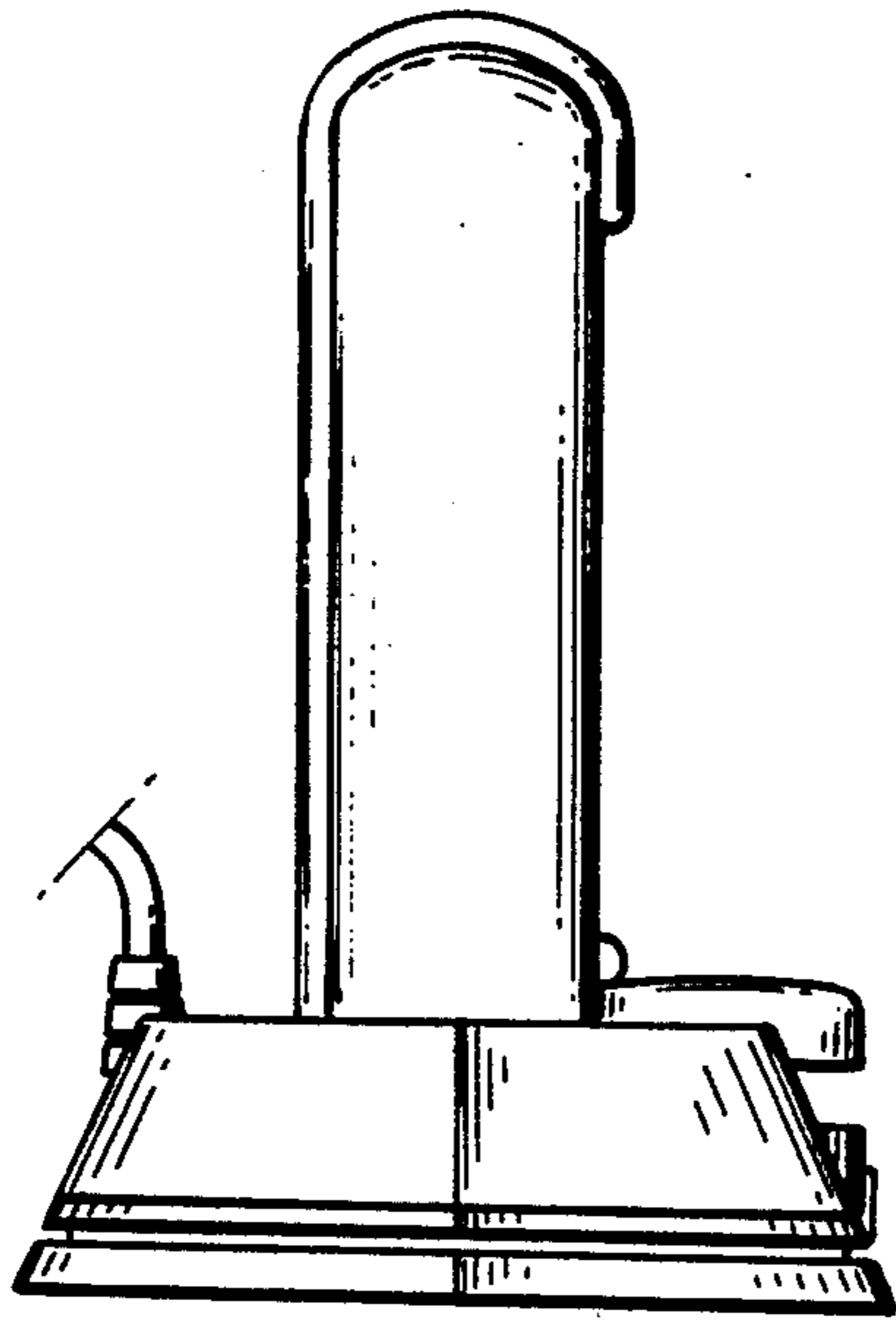

FIG. 3.

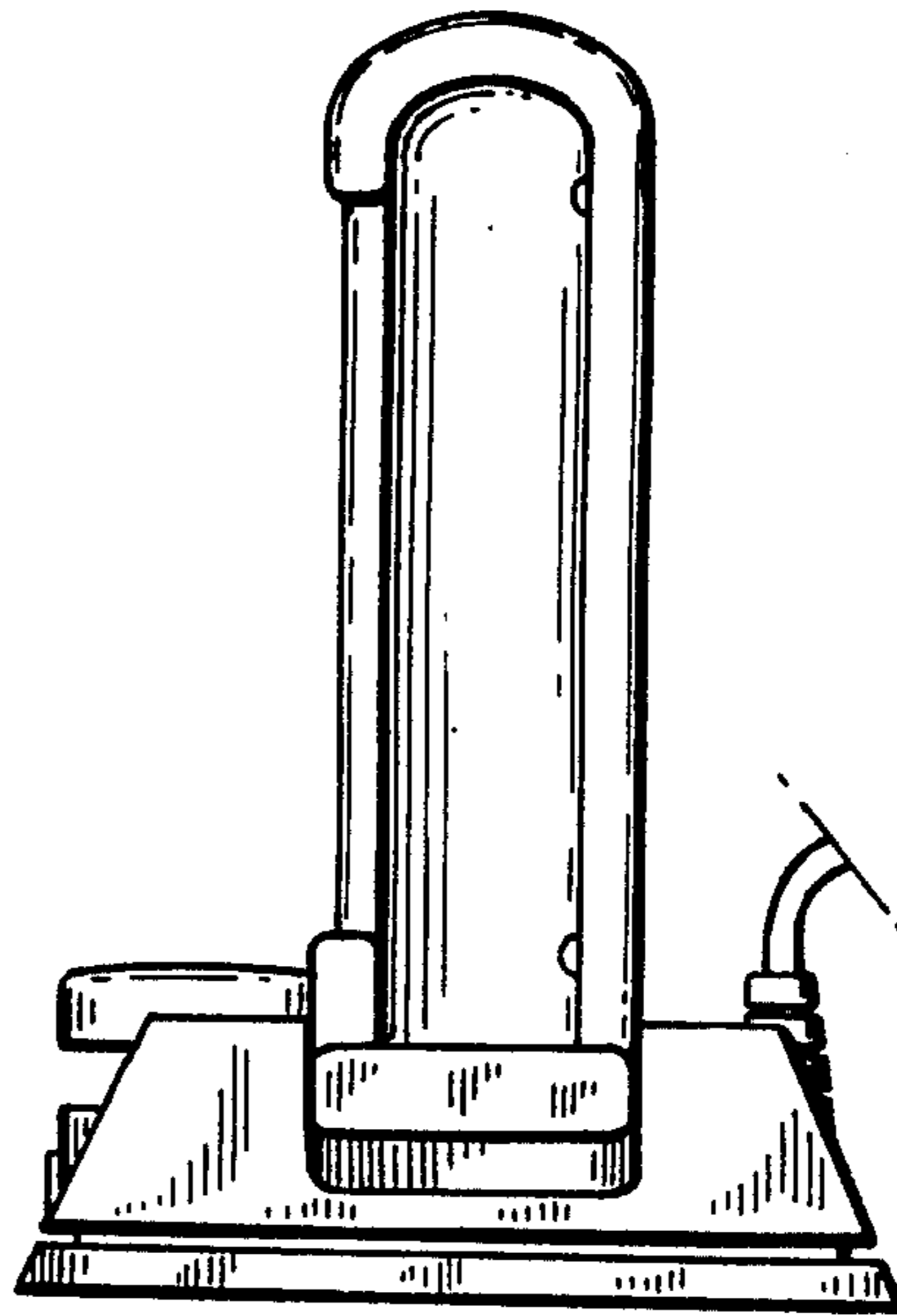

FIG. 4.

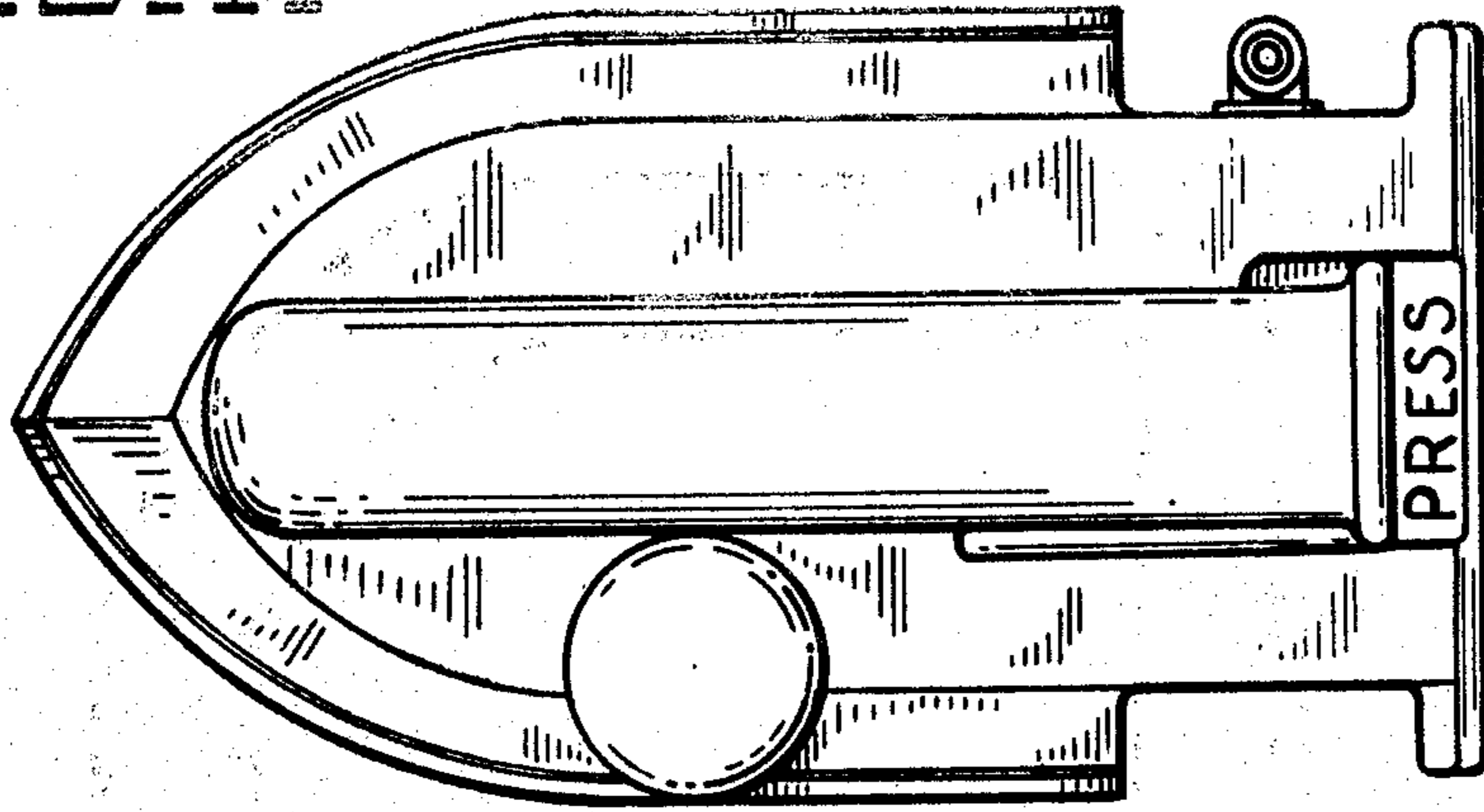

FIG. 6.

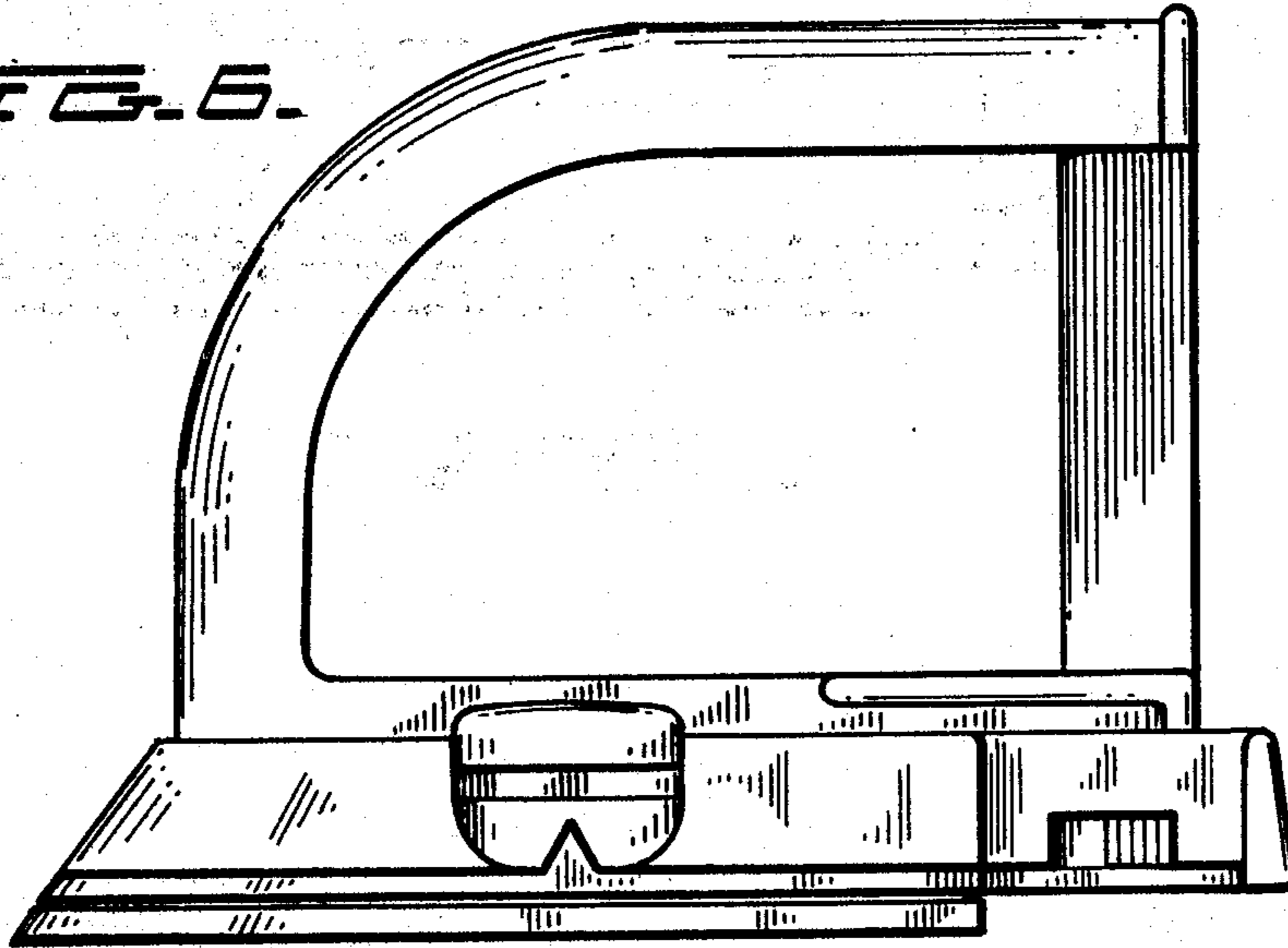
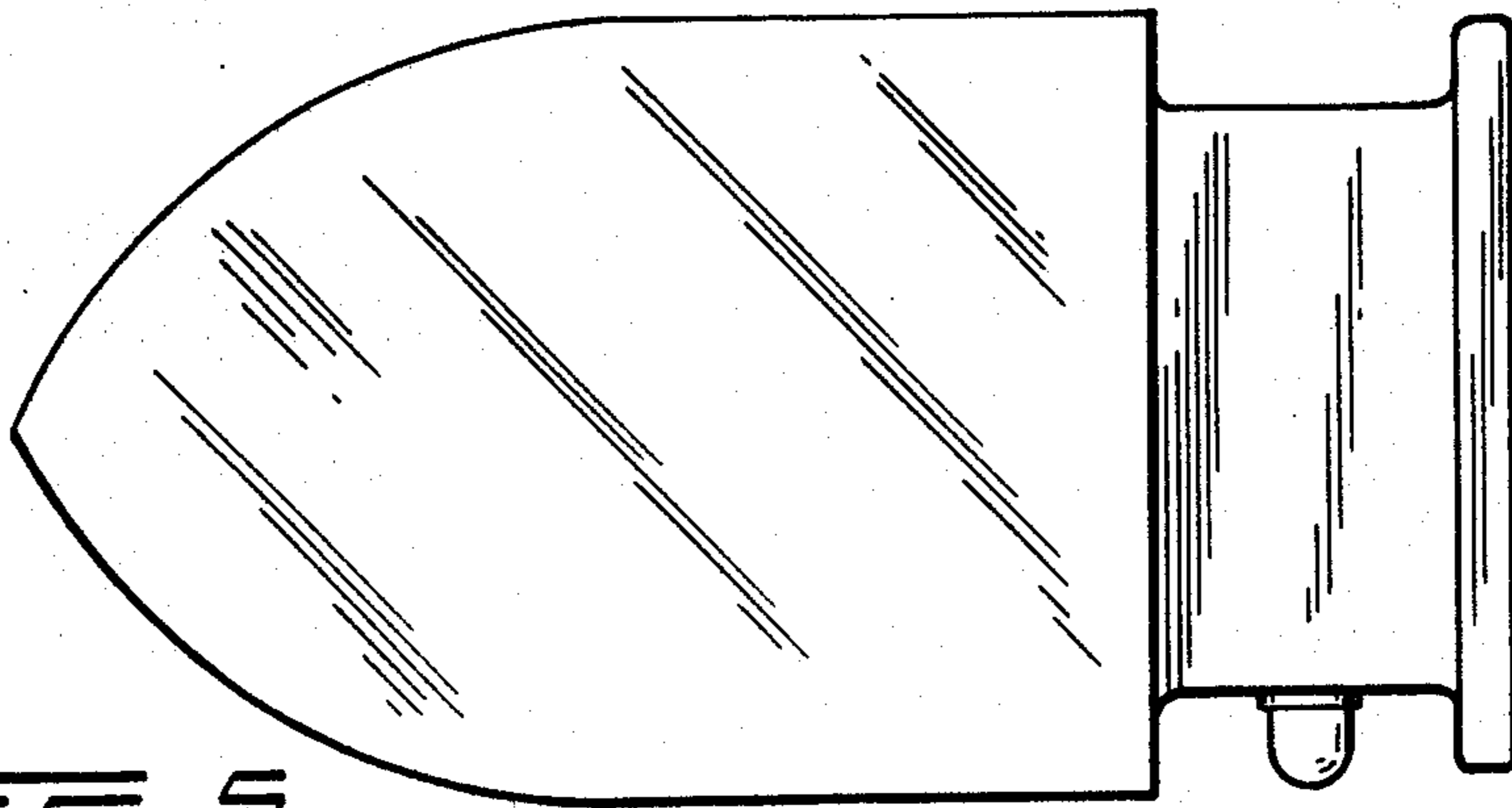

FIG. 5.



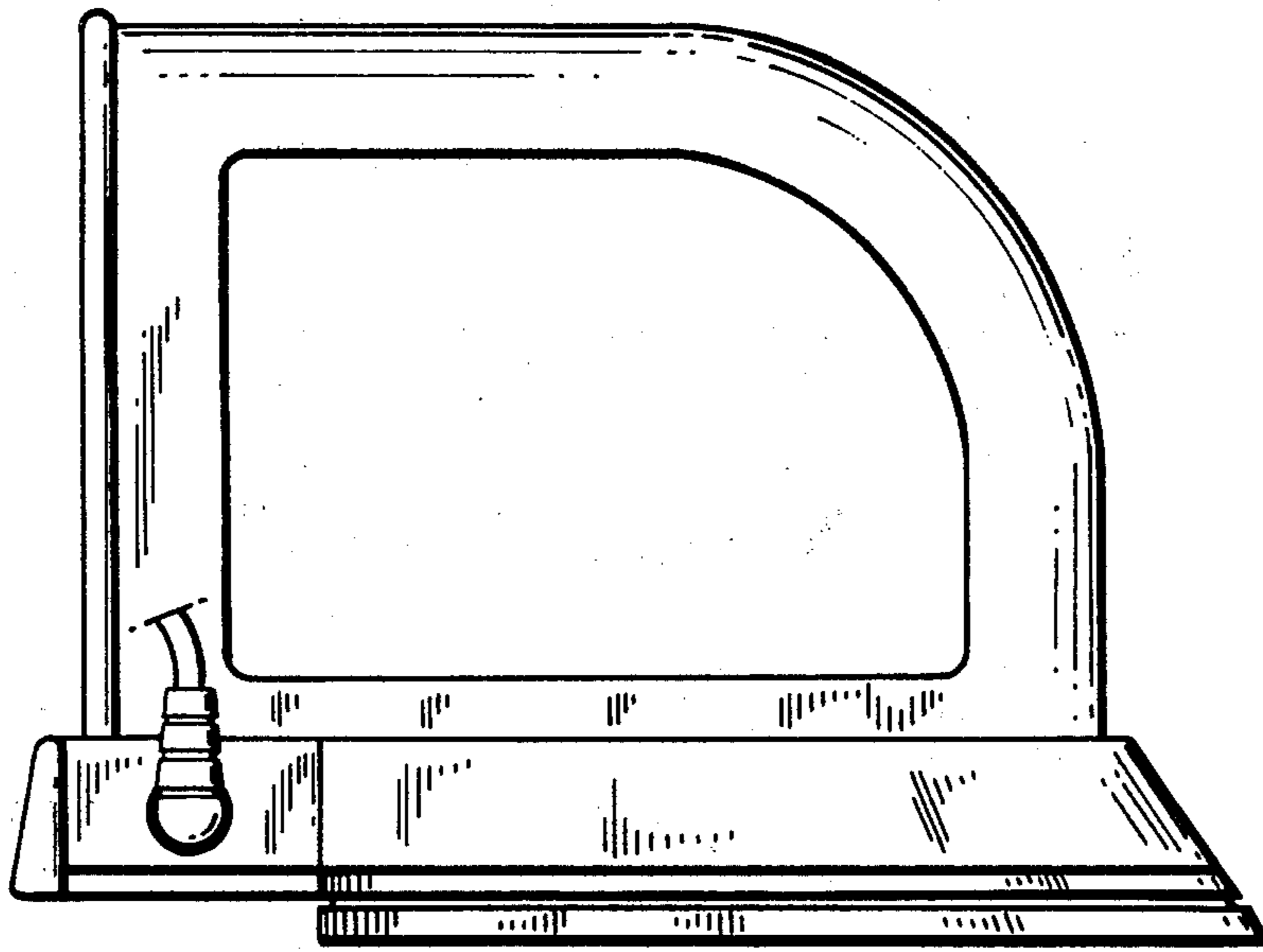
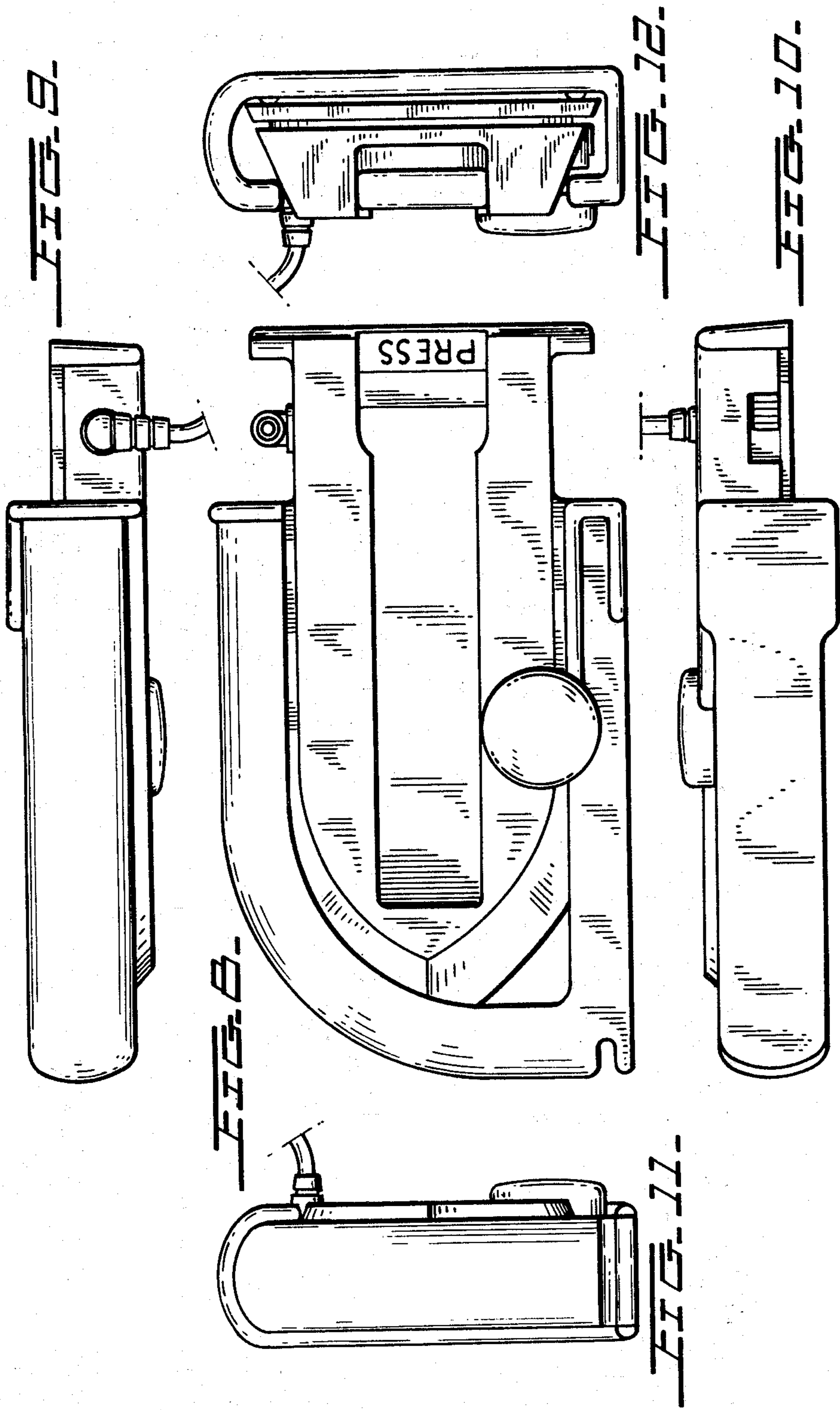

FIG. 7.



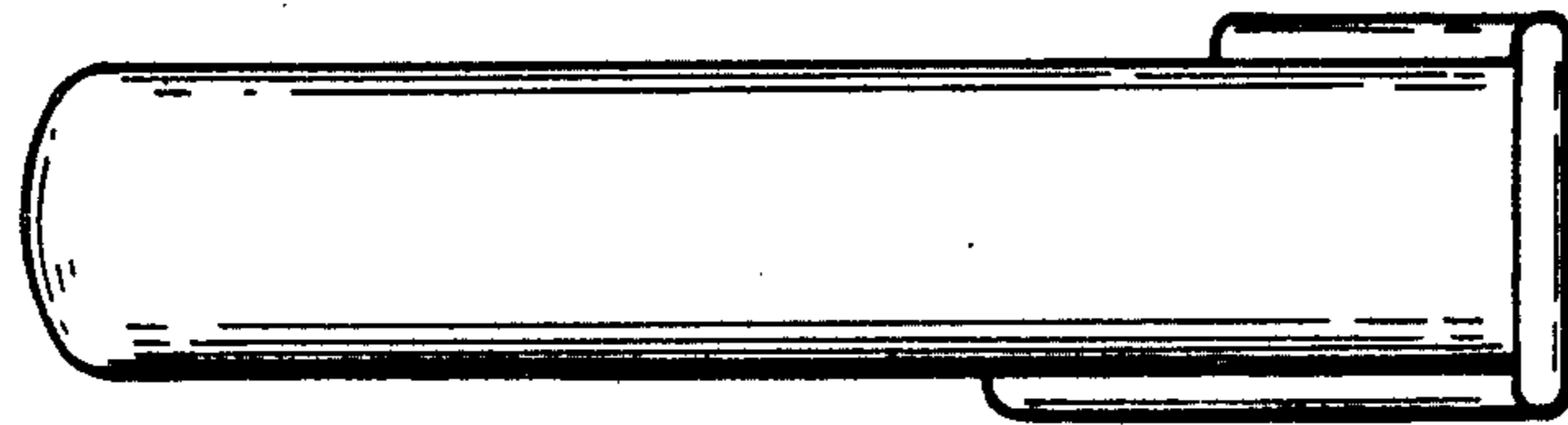

FIG. 15.

FIG. 13.

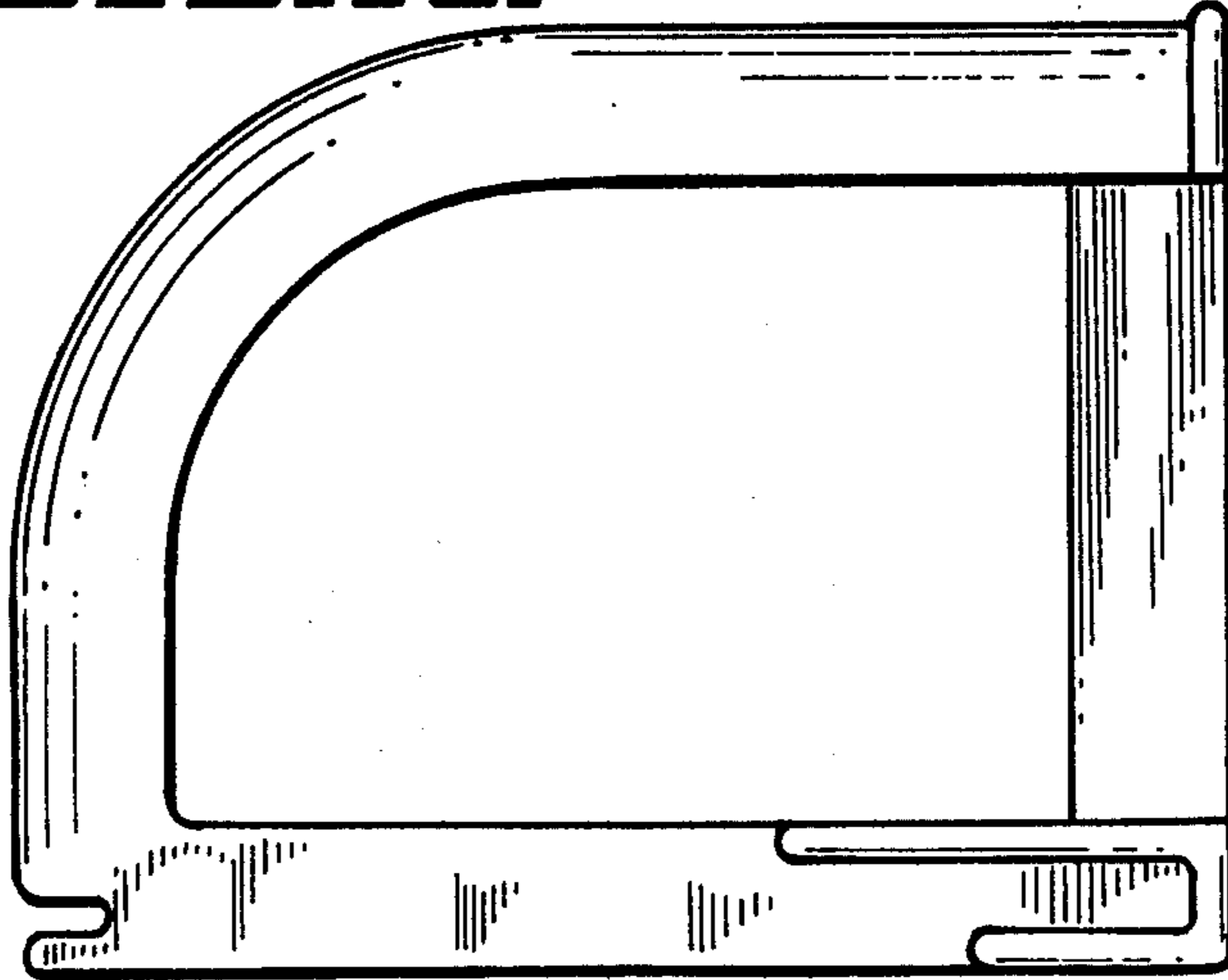

FIG. 17.

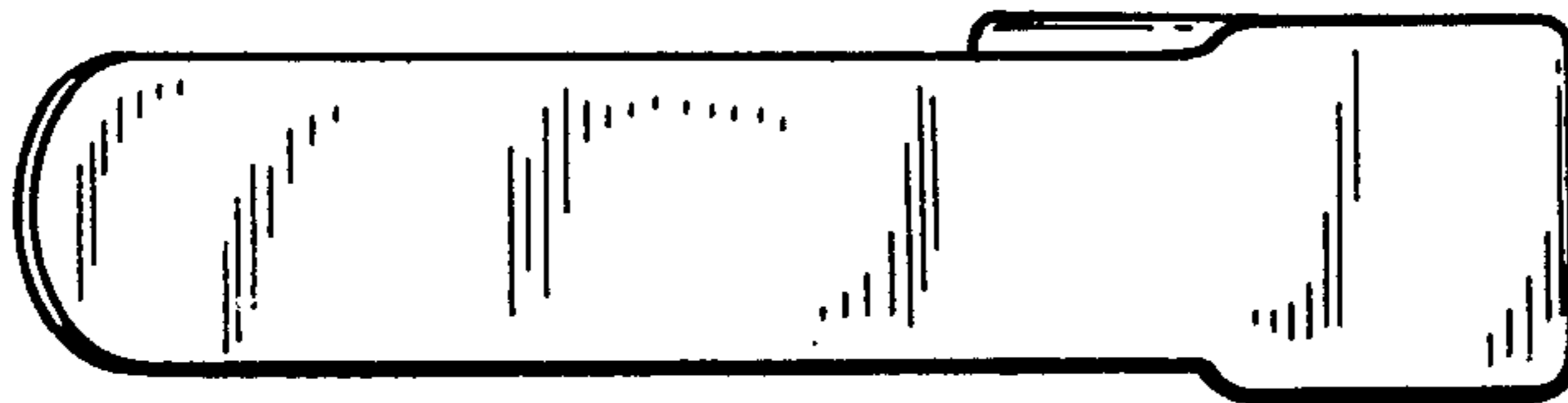

FIG. 16.

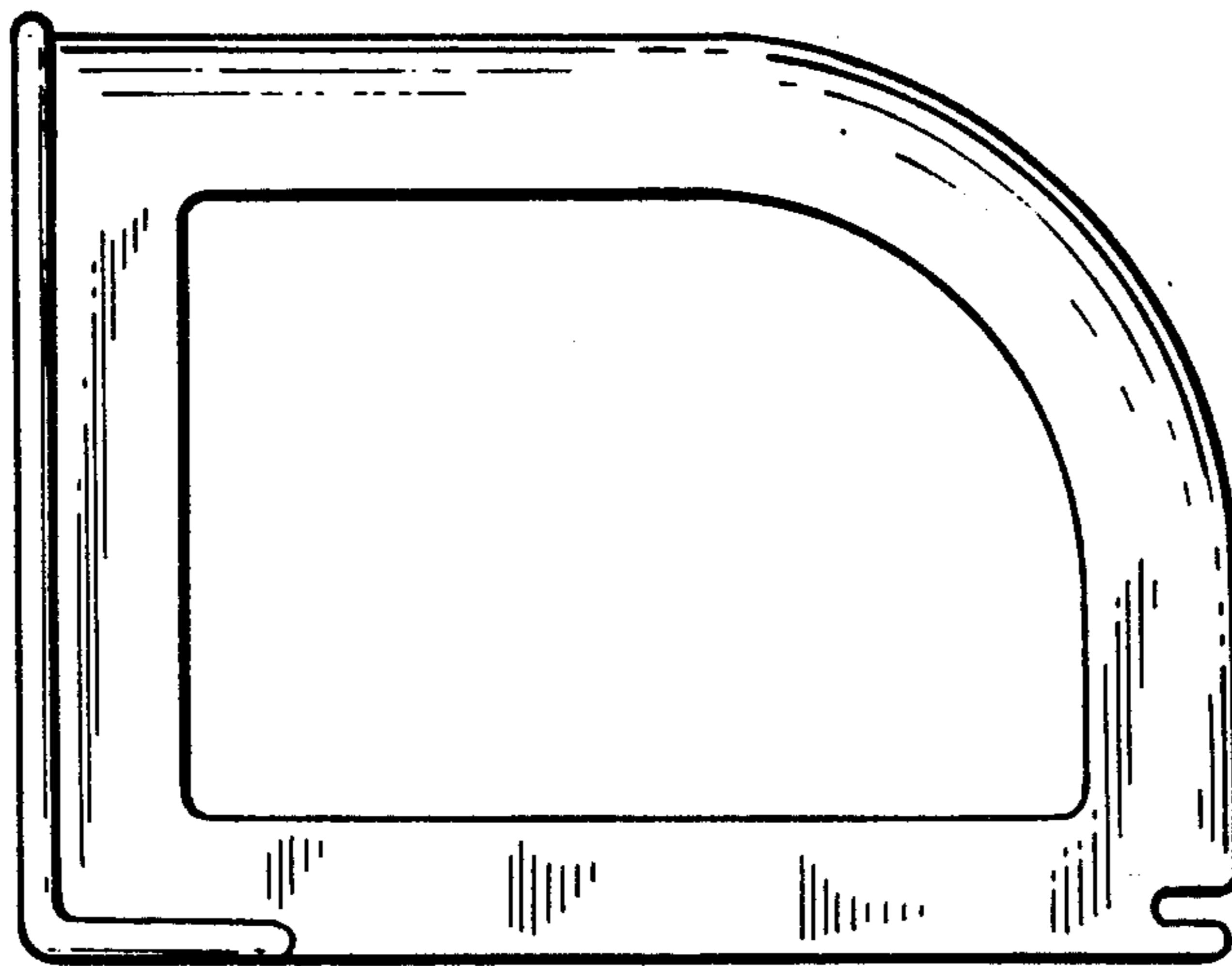

FIG. 14.

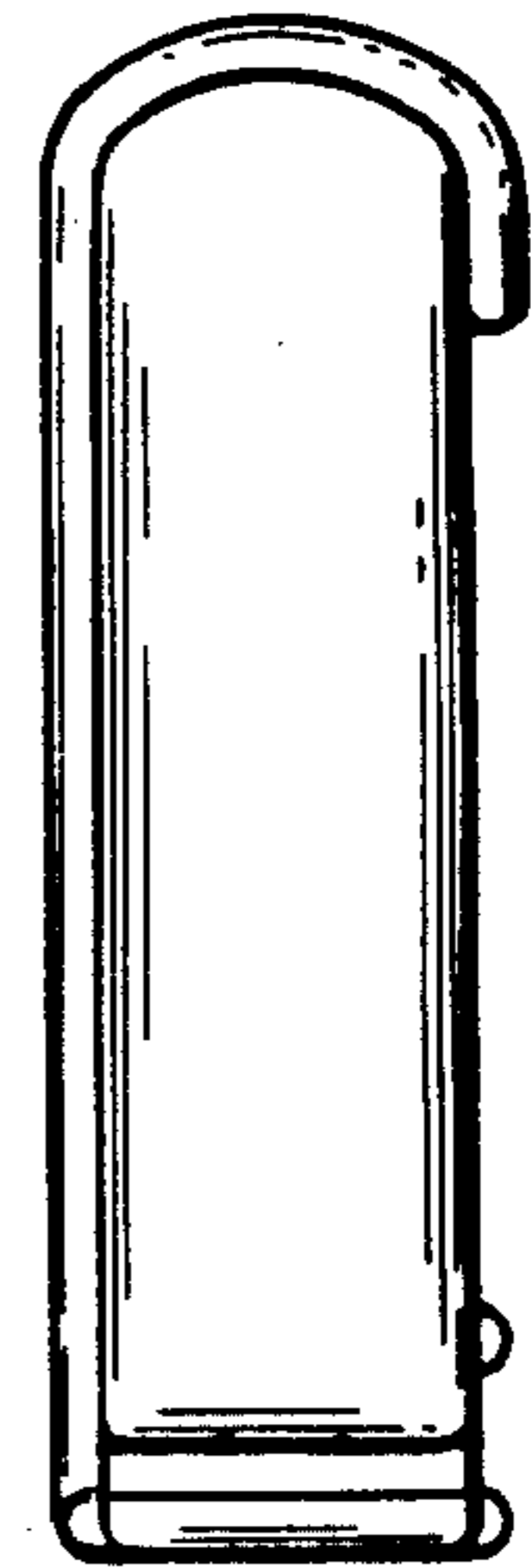

FIG. 18.