

[54] CABINET

[76] Inventor: Jerry J. Noonchester, 10841 Westpointe, Taylor, Mich. 48180

[**] Term: 14 Years

[21] Appl. No.: 284,625

[22] Filed: Jul. 20, 1981

[52] U.S. Cl. D6/440; D6/447; D34/20

[58] Field of Search D6/158, 159, 160, 164, D6/167, 168, 169, 170, 174, 186, 129; D34/19, 20, 21; D14/18, 33, 22

[56] References Cited

U.S. PATENT DOCUMENTS

- D. 84,471 6/1931 French D6/159 X
- D. 229,442 11/1973 Mohn D14/22
- D. 237,415 10/1975 Davis D14/18
- D. 244,924 7/1977 Scheibner D6/186 X
- D. 257,881 1/1981 Winig D6/129 X

OTHER PUBLICATIONS

Material Handling Factory and Office Equipment, Cat.

No. 47A, by Global Equipment Co. ©1974, p. 84, "Cabinet Bench", left column third from bottom.

Primary Examiner—Nelson C. Holtje
Assistant Examiner—Carmen H. Vales
Attorney, Agent, or Firm—Norbert M. Lisicki

[57] CLAIM

The ornamental design for a cabinet, substantially as shown and described.

DESCRIPTION

FIG. 1 is a perspective view of a cabinet showing my new design;
 FIG. 2 is a front elevational view thereof;
 FIG. 3 is a left side elevational view with the drawer having a raised shelf in the open position for the convenience of illustration;
 FIG. 4 is a rear elevational view thereof;
 FIG. 5 is a right side elevational view thereof;
 FIG. 6 is a top plan view thereof; and
 FIG. 7 is a bottom plan view thereof.

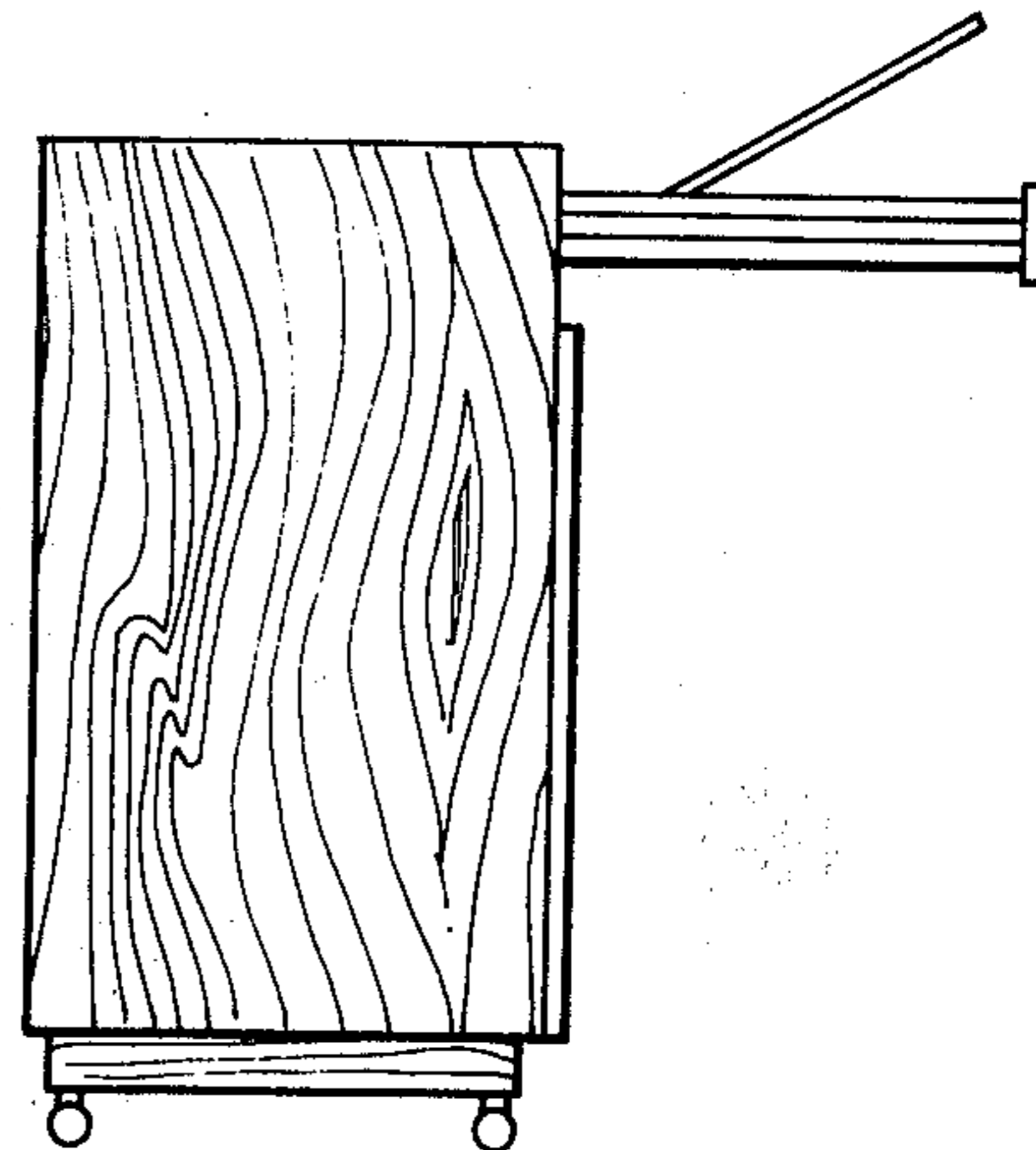
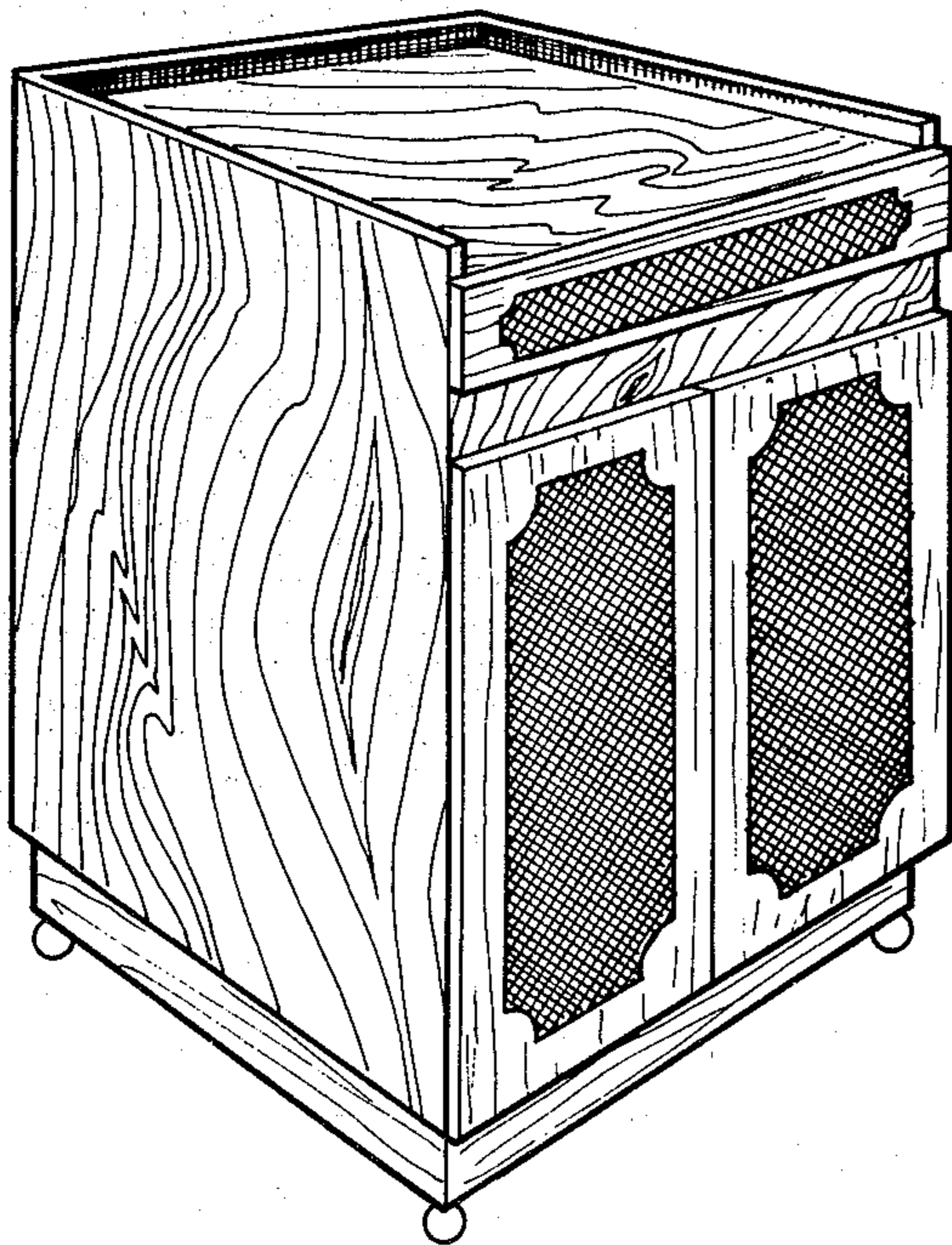

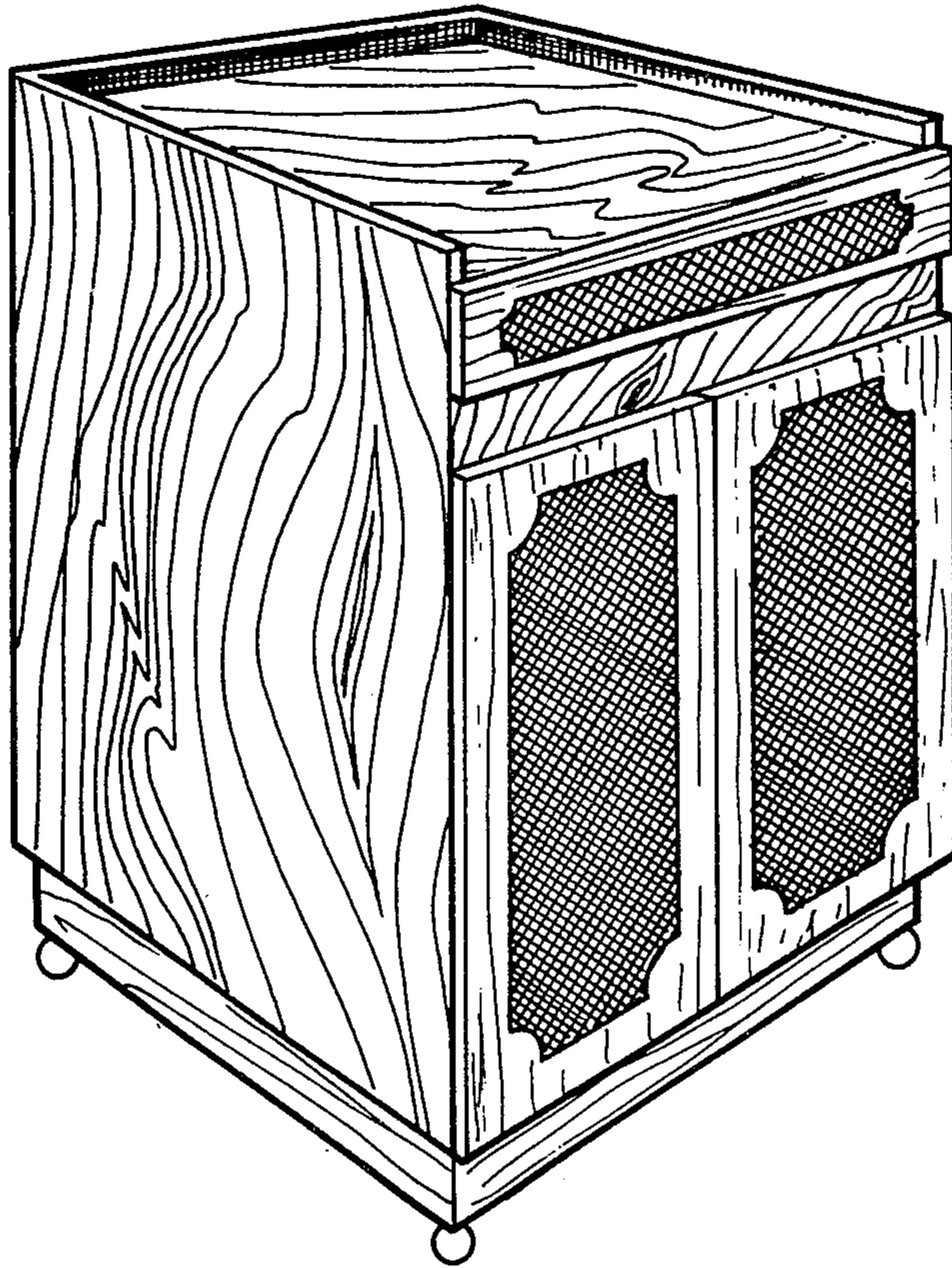

Fig-1

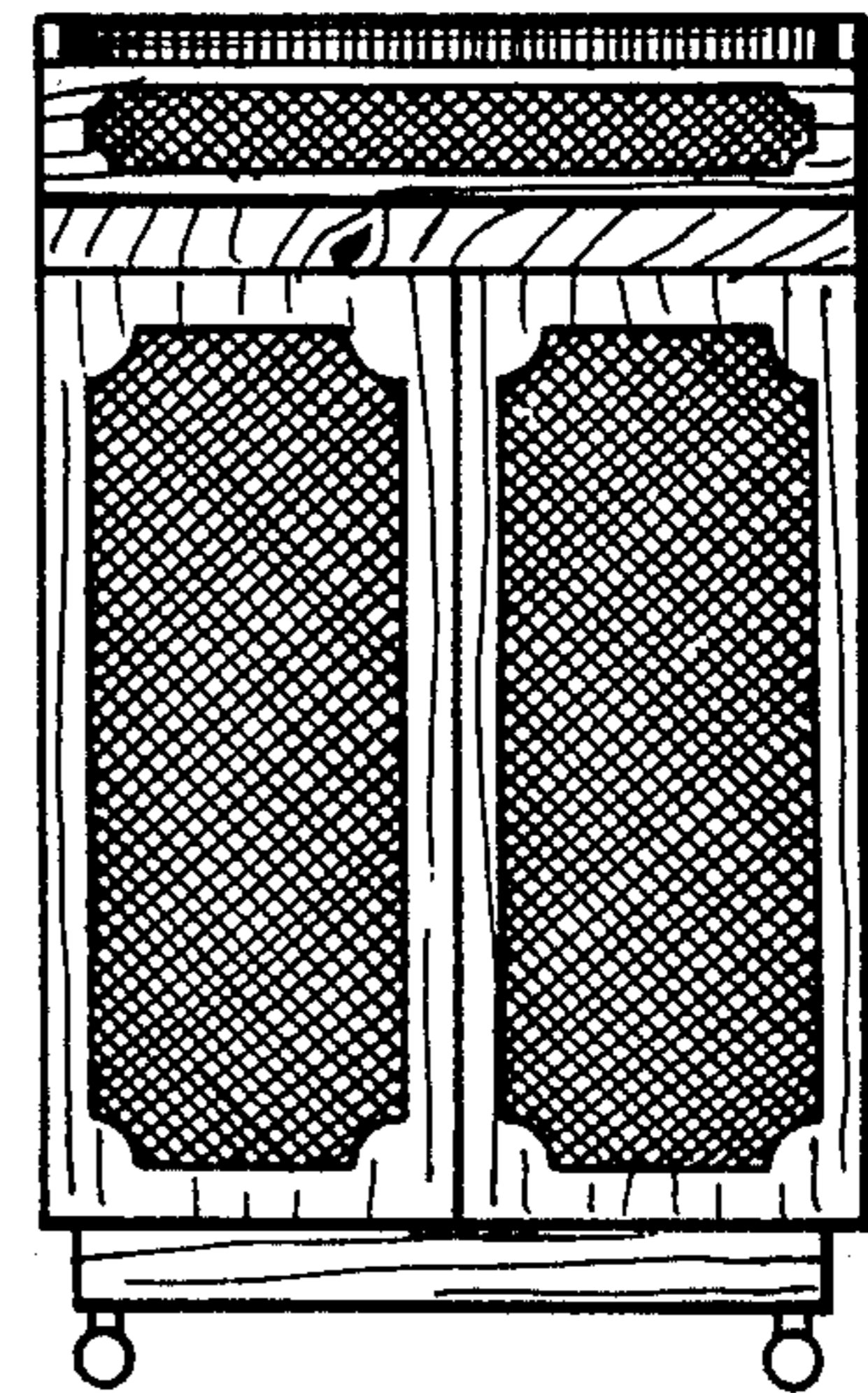

Fig-2

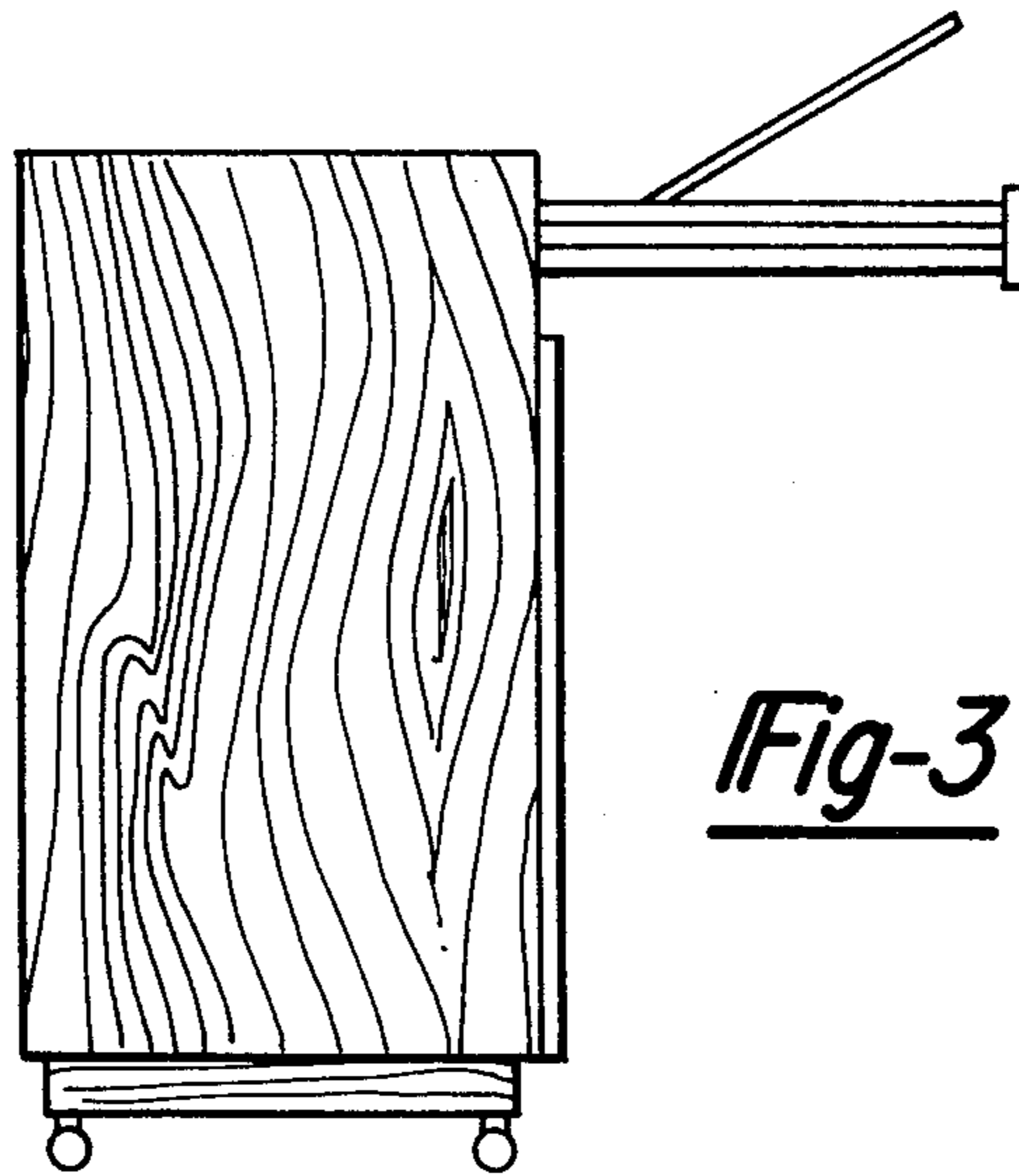

Fig-3

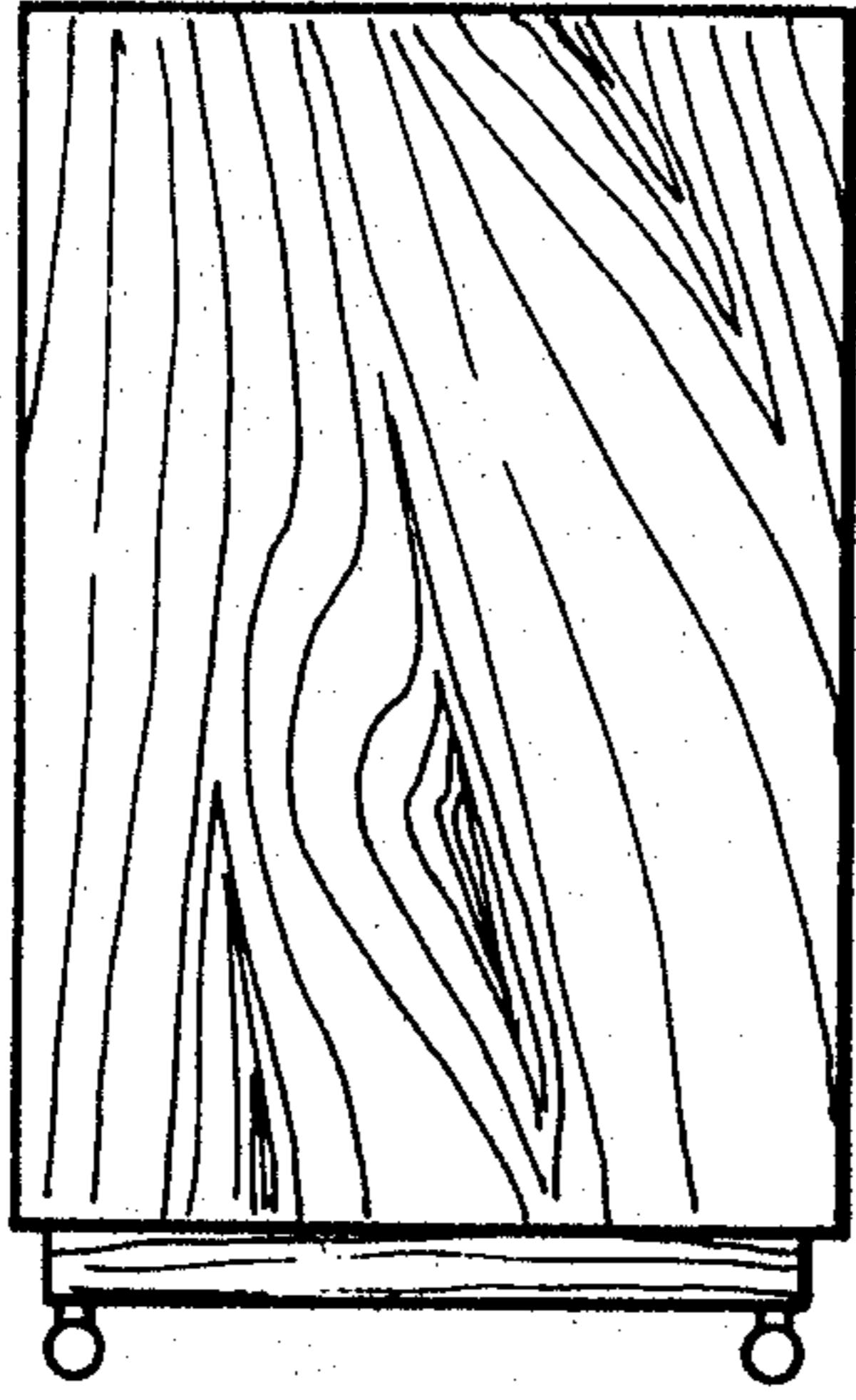

Fig-4



Fig-5

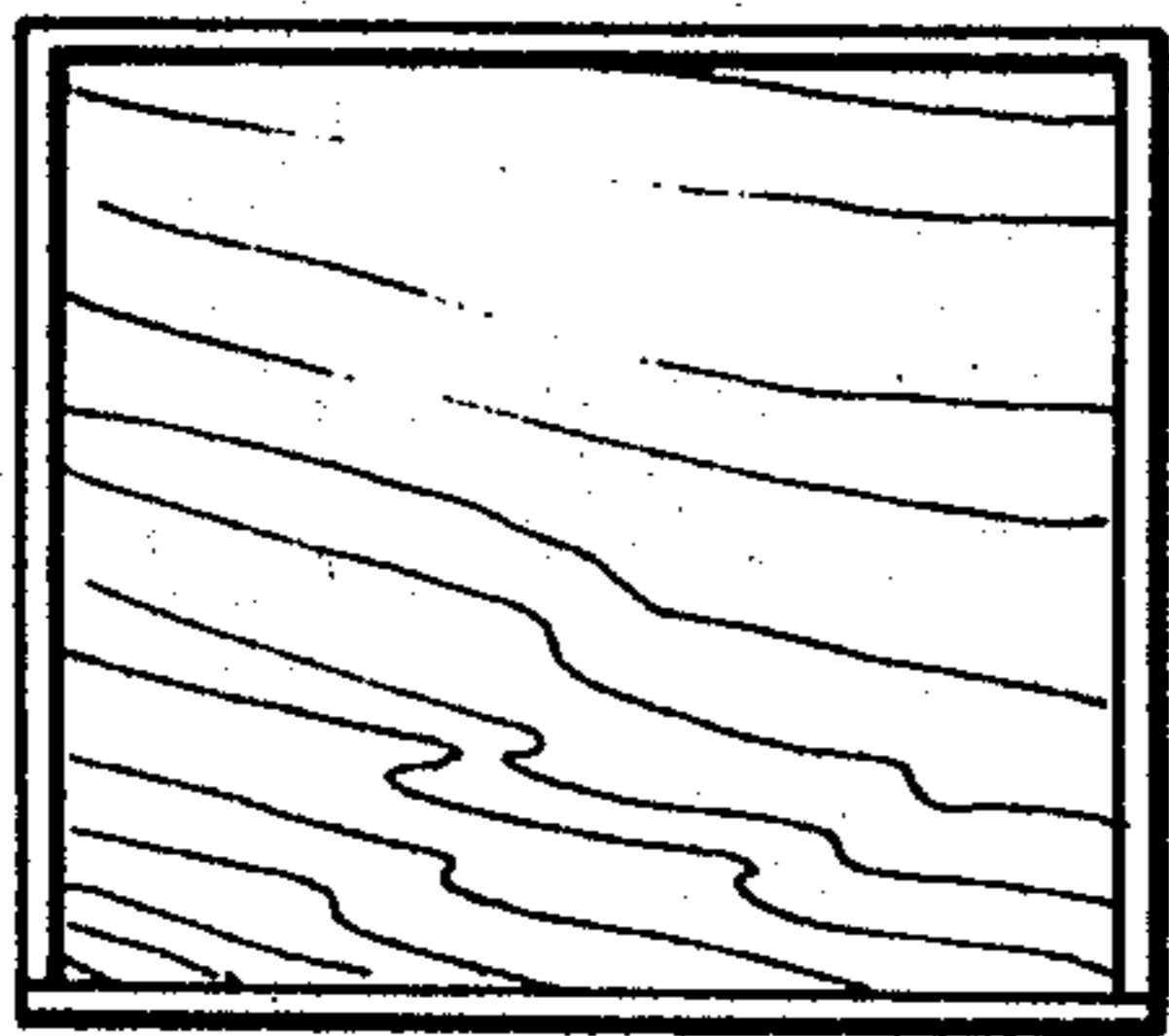

Fig-6

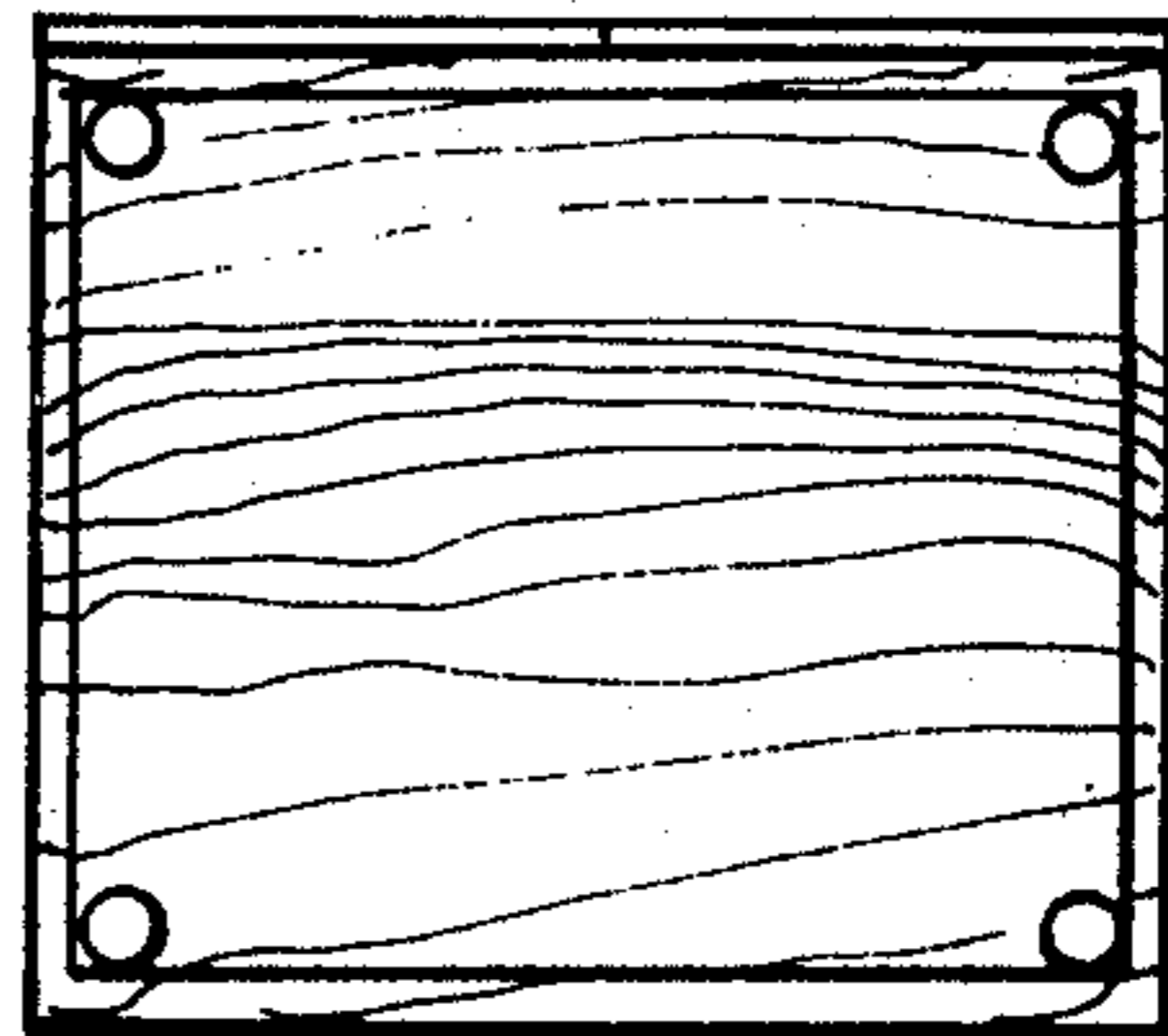

Fig-7