

[54] TOY VEHICLE

[75] Inventors: Shinroku Nakao, Kanagawa;
Yoshiyasu Ishii; Hiroaki Matsuda,
both of Tokyo, all of Japan

[73] Assignee: Combi Co., Ltd., Tokyo, Japan

[**] Term: 14 Years

[21] Appl. No.: 356,072

[22] Filed: Mar. 8, 1982

[30] Foreign Application Priority Data

Dec. 7, 1981 [JP] Japan 56-54112
[52] U.S. Cl. D21/111; D21/64
[58] Field of Search D21/111, 64, 73, 76,
D21/128, 135, 136; 46/201, 98, 210, 111, 222,
112, 223; D14/53

[56]

References Cited

U.S. PATENT DOCUMENTS

D. 196,737 10/1963 Thornell D21/111
D. 257,865 1/1981 Wyman D21/134
D. 269,779 7/1983 Bevilacqua et al. D21/111

Primary Examiner—Charles A. Rademaker
Attorney, Agent, or Firm—Sughrue, Mion, Zinn,
MacPeak & Seas

[57]

CLAIM

The ornamental design for a toy vehicle, as shown and described.

DESCRIPTION

FIG. 1 is a front, top and right side perspective view of a toy vehicle showing our new design;
FIG. 2 is a rear elevational view thereof, with the lift-able hand set in place;
FIG. 3 is a front elevational view thereof;
FIG. 4 is a top plan view thereof;
FIG. 5 is a bottom plan view thereof;
FIG. 6 is a left side elevational view thereof; and
FIG. 7 is a right side elevational view thereof.

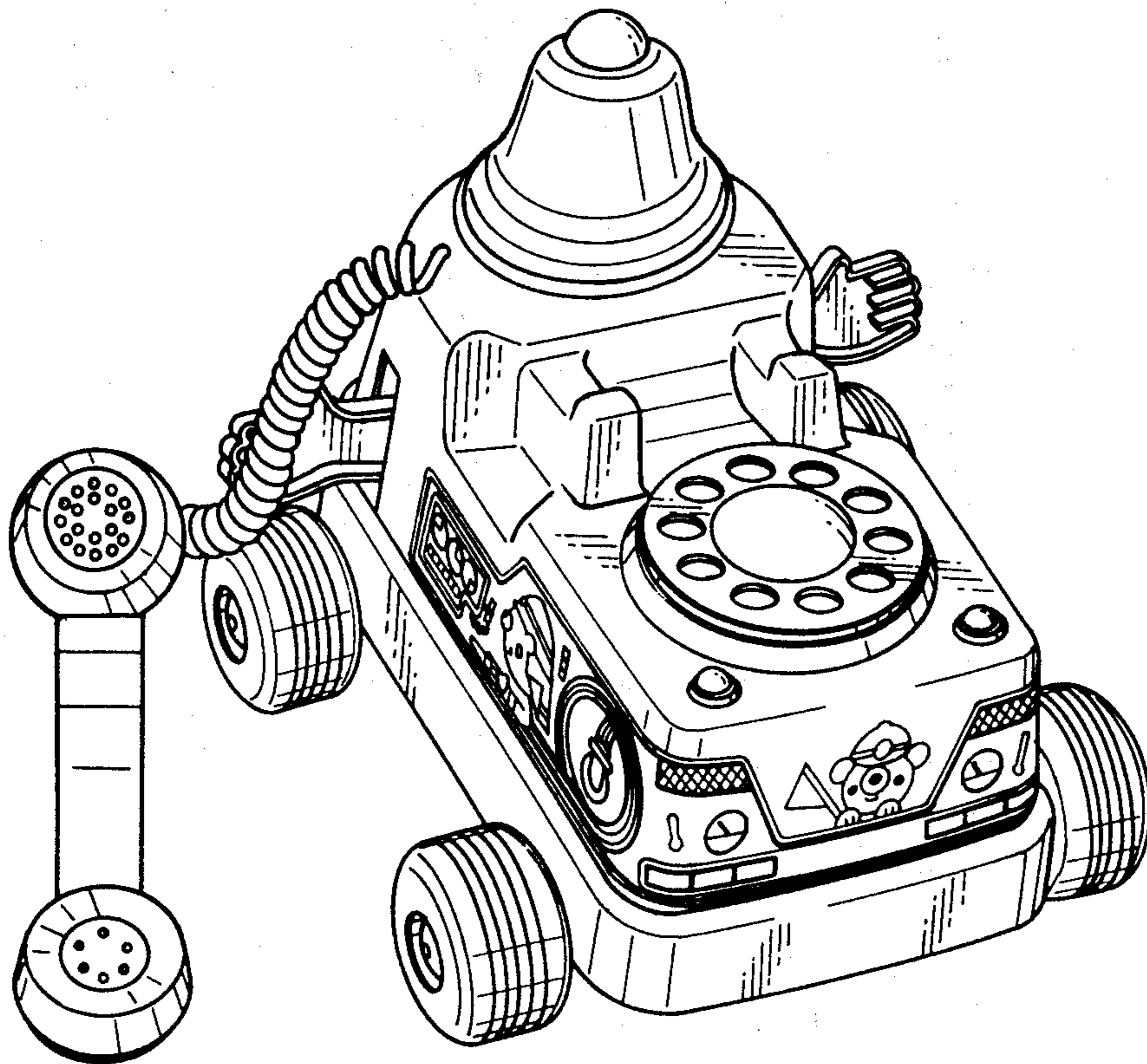

Fig. 1

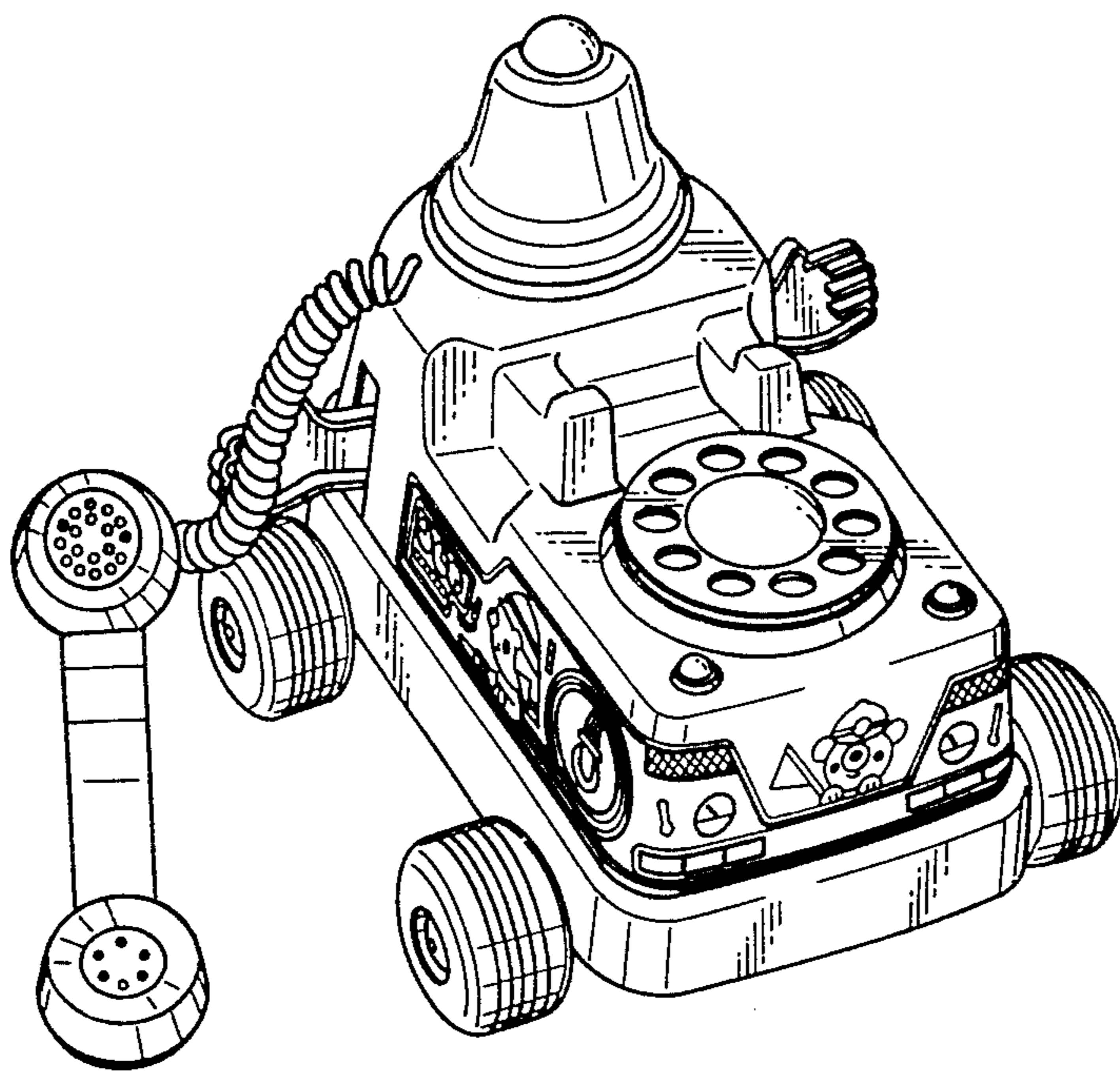

Fig. 2

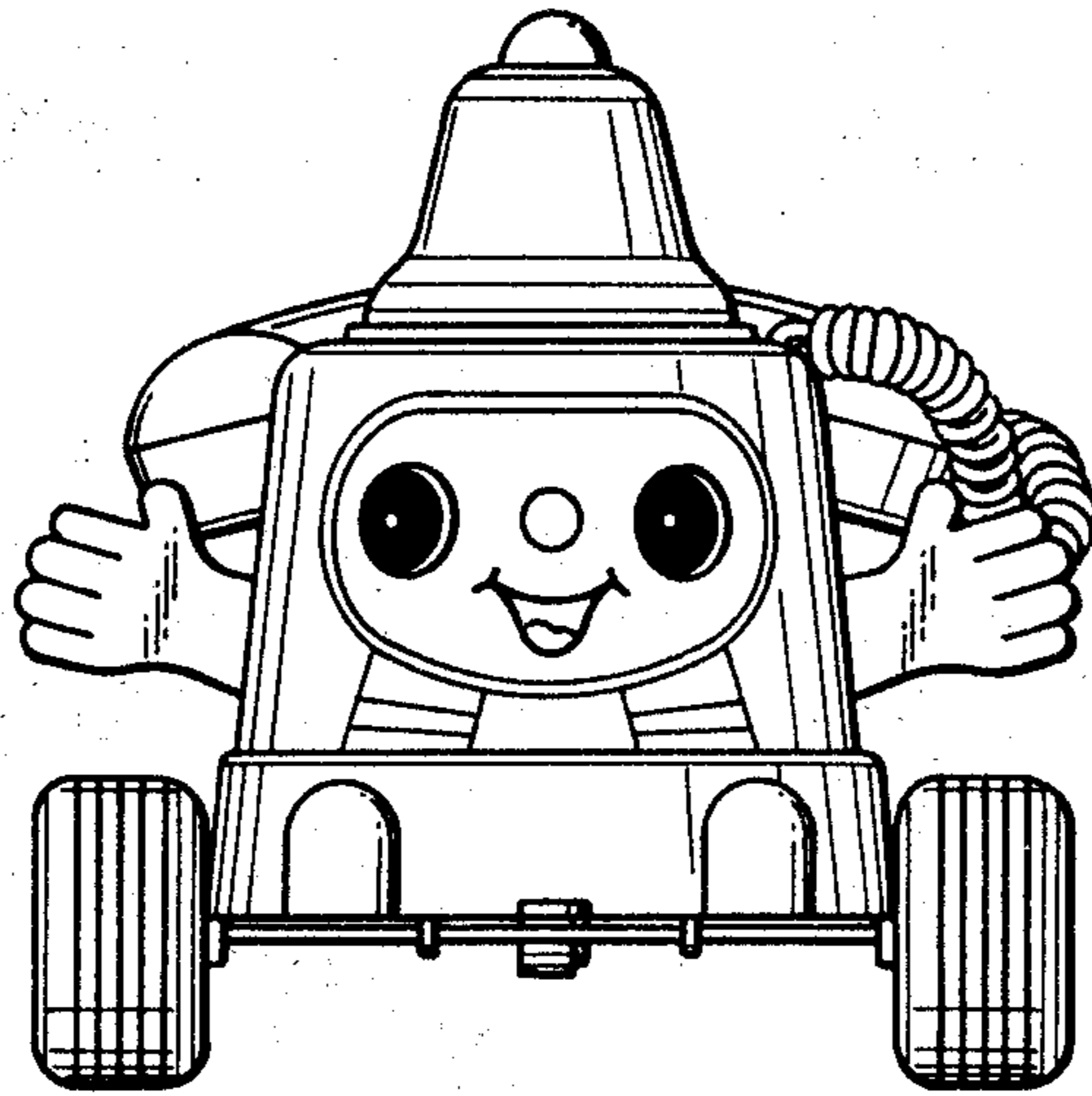

Fig. 3

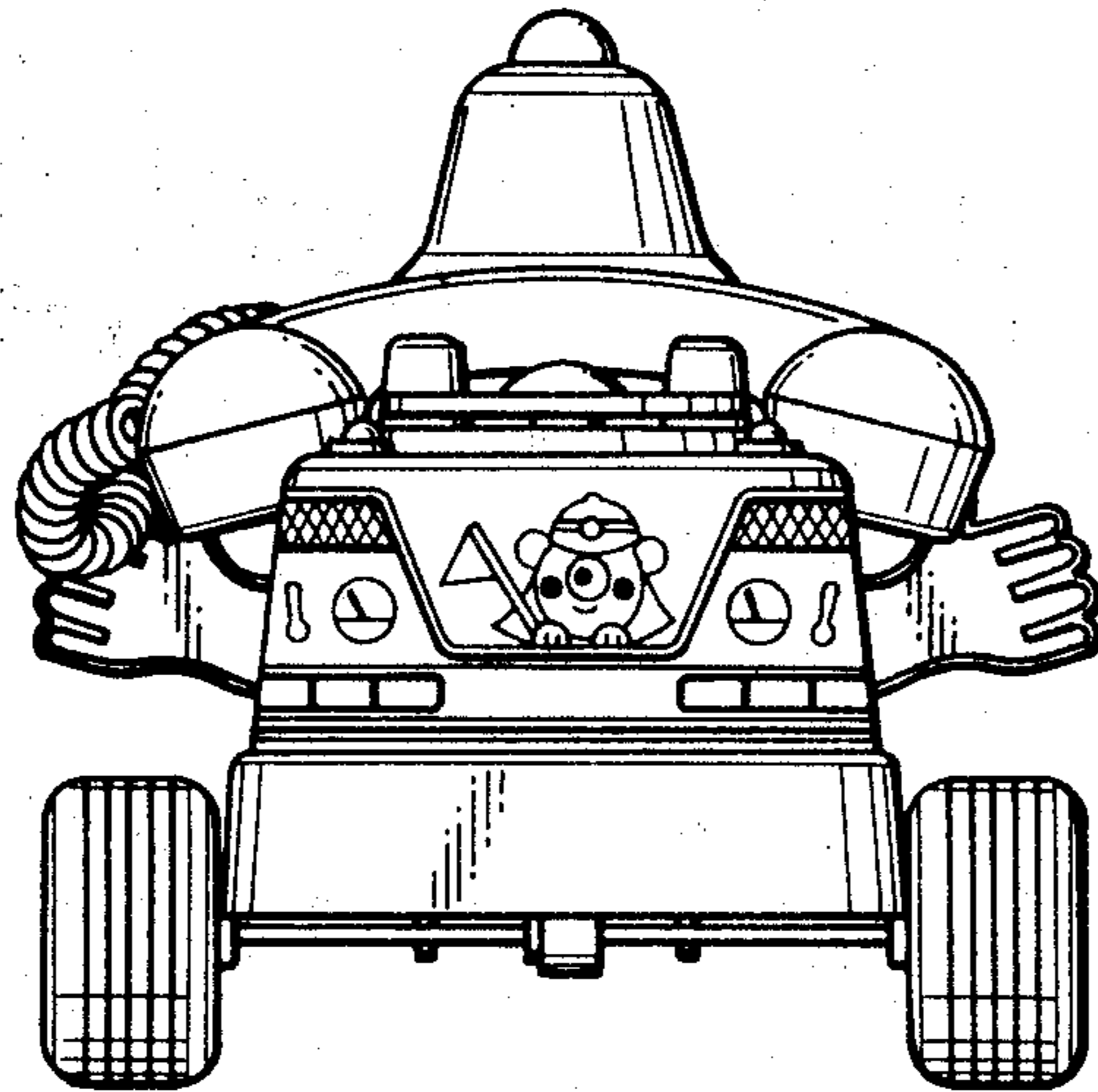

Fig. 4

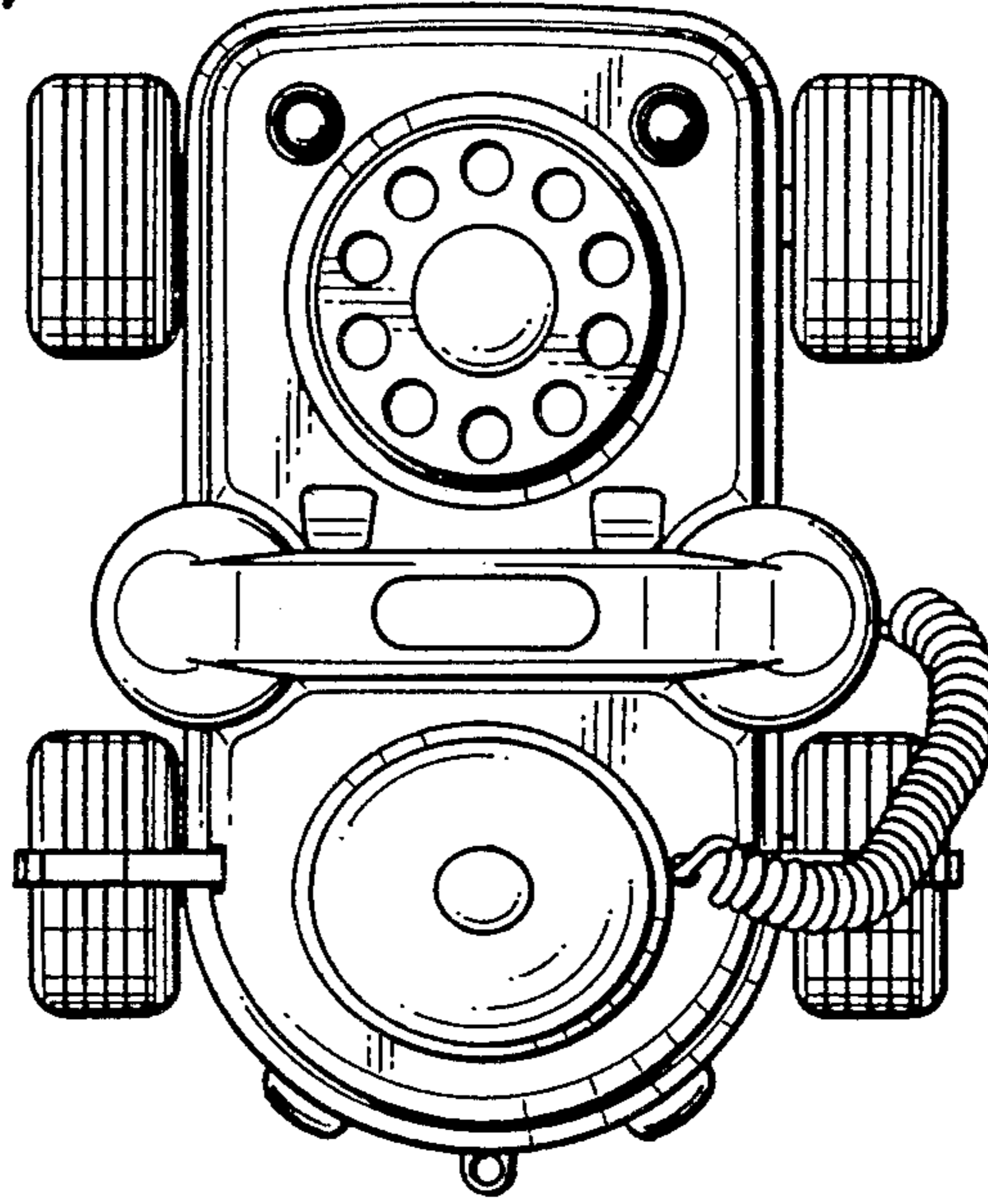

Fig. 5

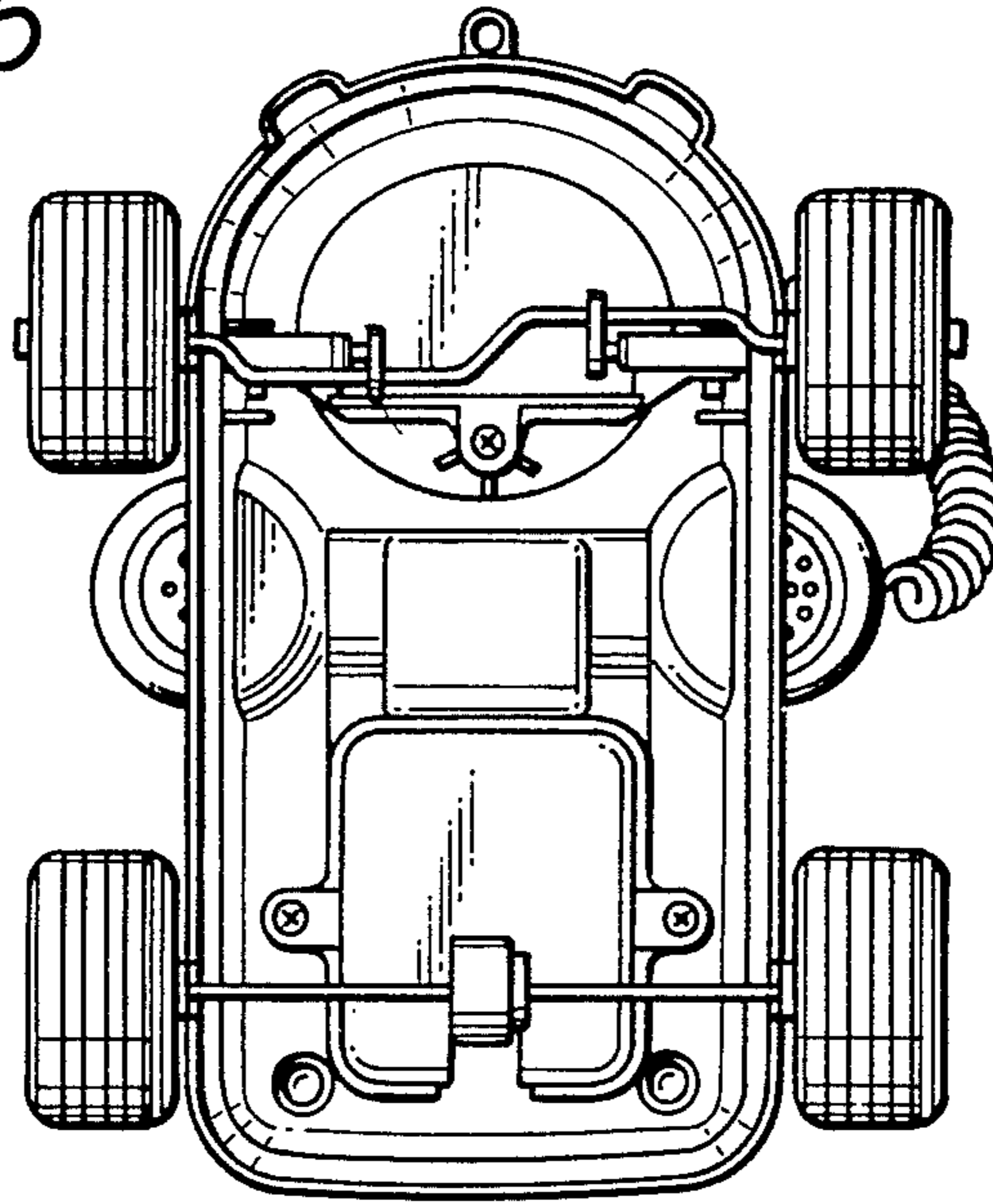

Fig. 6

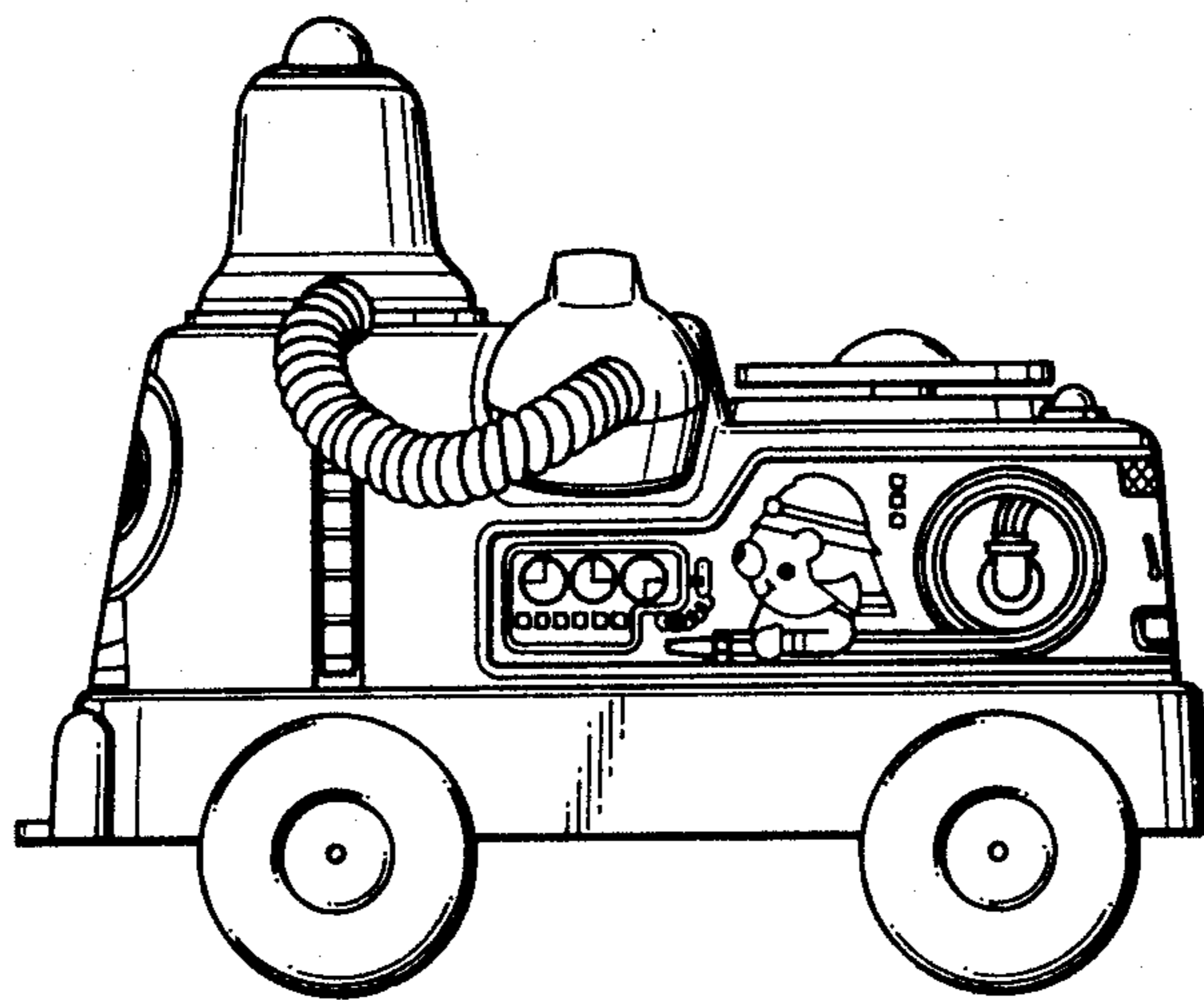

Fig. 7

