

[54] COPY MACHINE CONTROLLER

[75] Inventor: Stuart W. Sizer, Harbert, Mich.

[73] Assignee: Swiss Controls Inc., Michigan City, Ind.

[**] Term: 14 Years

[21] Appl. No.: 361,830

[22] Filed: Mar. 25, 1982

[52] U.S. Cl. D16/32; D14/115

[58] Field of Search D16/27, 29, 30, 31, D16/32; D14/115 X; 355/3 R, 8 R, 9 R, 14 R

[56] References Cited

U.S. PATENT DOCUMENTS

- D. 194,502 2/1963 Hollerith D14/115
- D. 212,227 9/1968 Del Vecchio D16/32
- D. 224,054 6/1972 Perry D16/30
- D. 227,931 7/1973 Dalton D16/30
- D. 236,133 7/1975 Kaner D14/115
- D. 236,379 8/1975 Yanofsky D16/30

- D. 237,905 12/1975 Knodt D16/27
- D. 247,243 2/1978 Nelson D14/115 X
- D. 268,345 3/1983 Robertson D16/30

Primary Examiner—Nelson C. Holtje
Attorney, Agent, or Firm—James M. Wetzel; Edward D. Manzo

[57] CLAIM

The ornamental design for a copy machine controller, substantially as shown and described.

DESCRIPTION

FIG. 1 is a front and top perspective view of a copy machine controller showing my new design;
 FIG. 2 is a right side elevational view thereof, the left side being a mirror image thereto;
 FIG. 3 is a cross-sectional view thereof as taken from line 3—3 of FIG. 4;
 FIG. 4 is a front elevational view thereof;
 FIG. 5 is a top plan view thereof, the bottom being substantially flat and unornamented;
 FIG. 6 is a rear elevational view thereof.

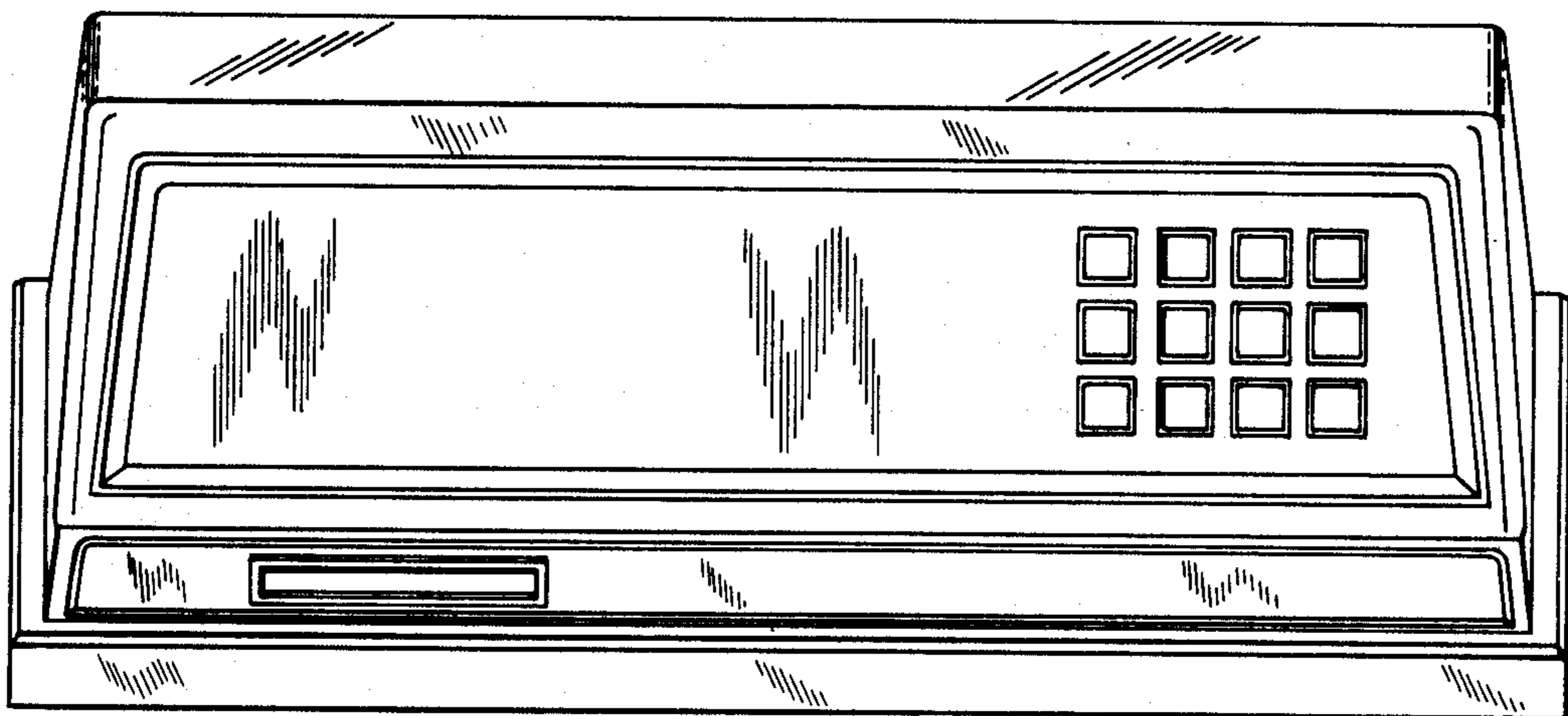

FIG. 1

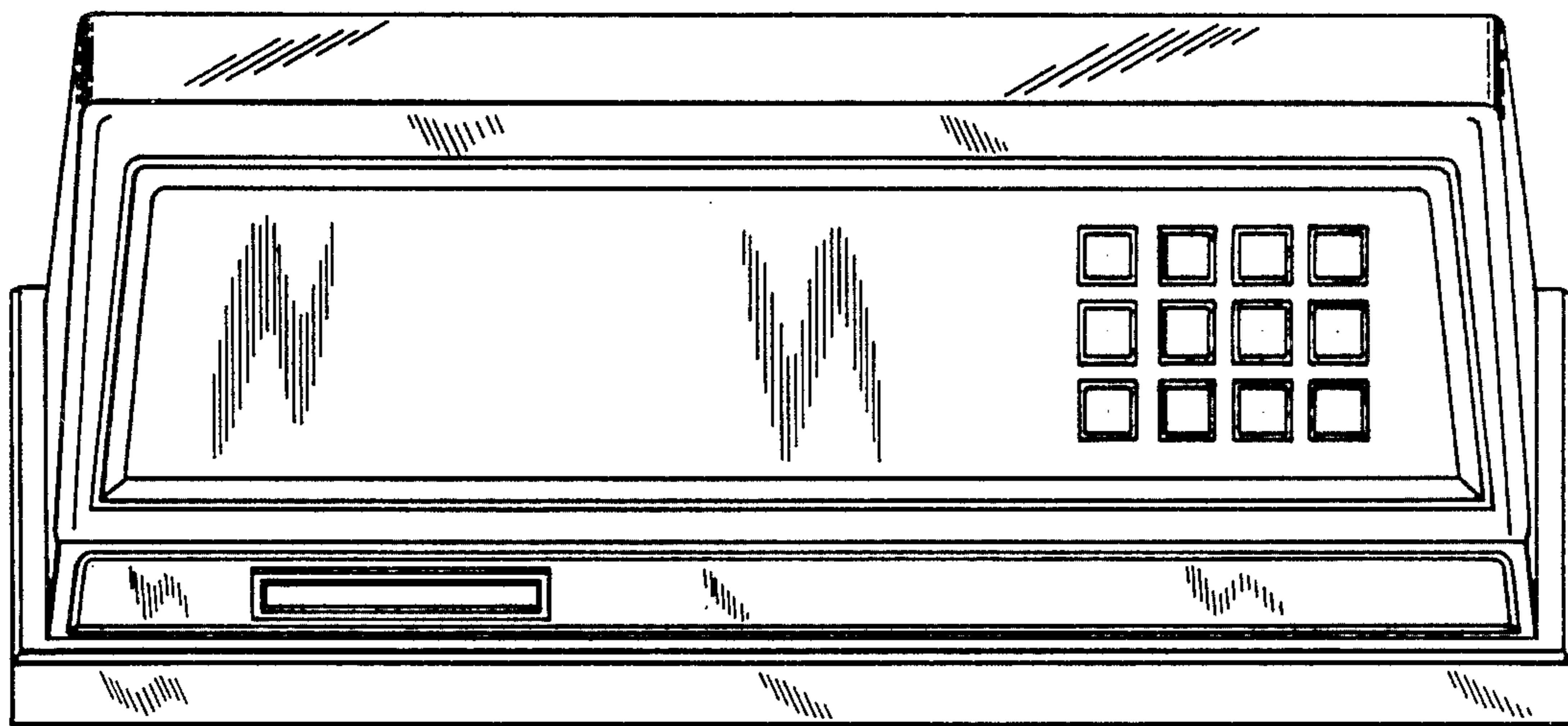

FIG. 2

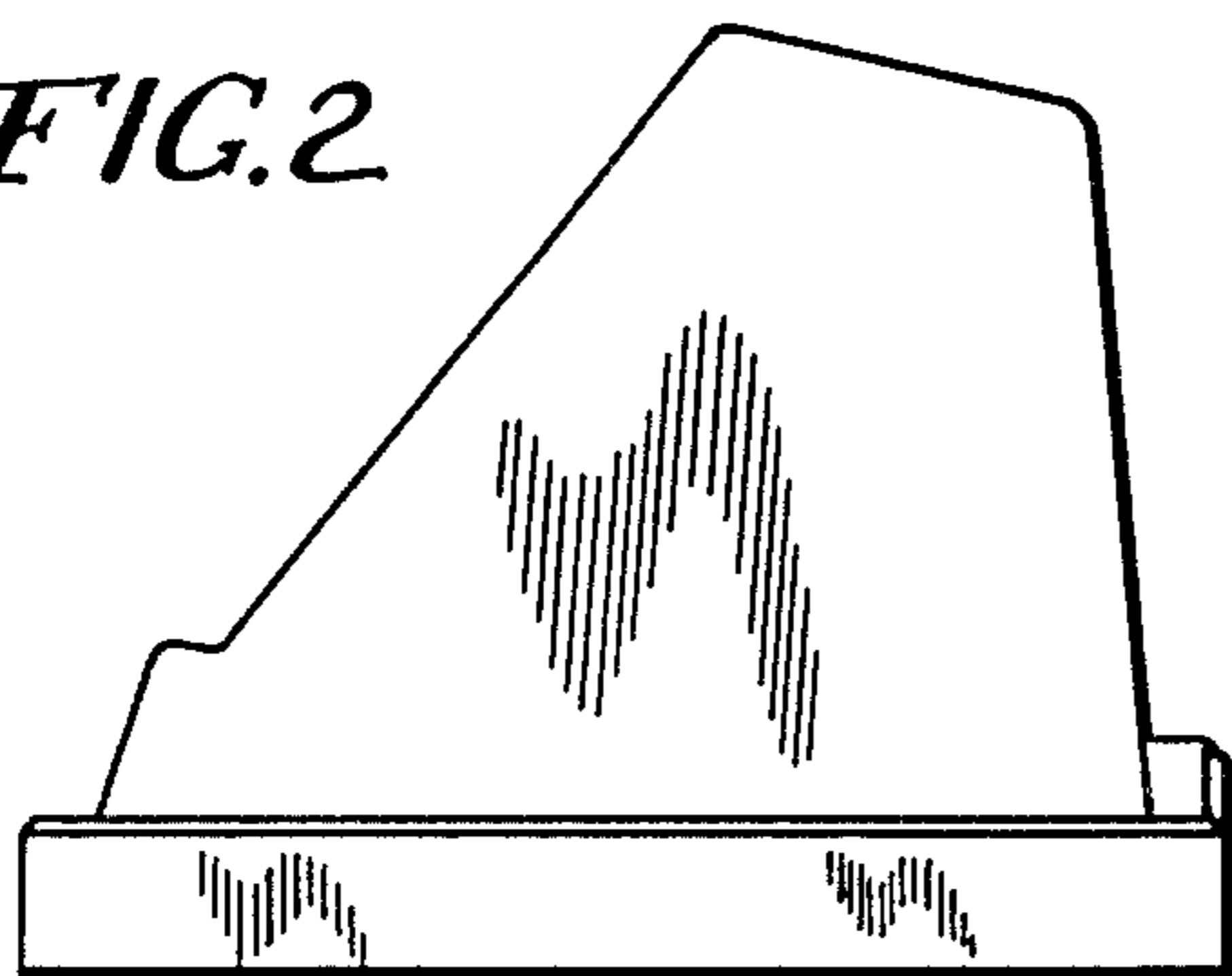
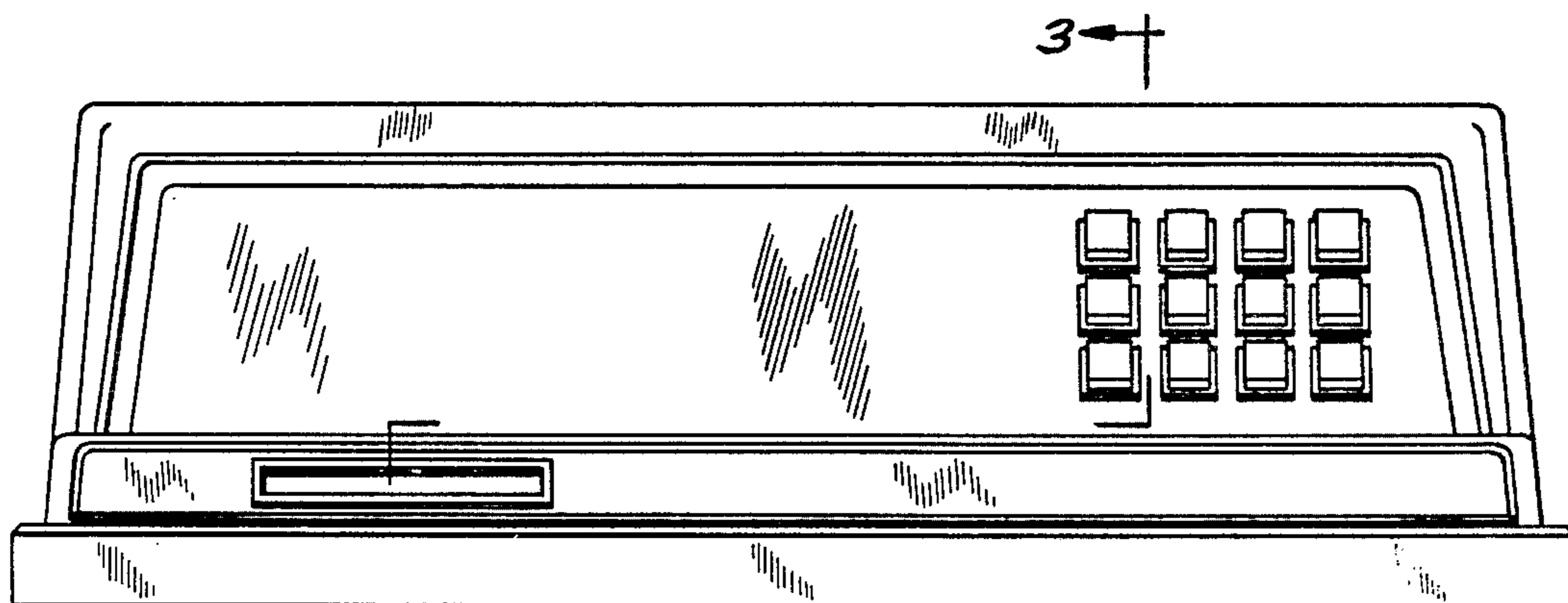
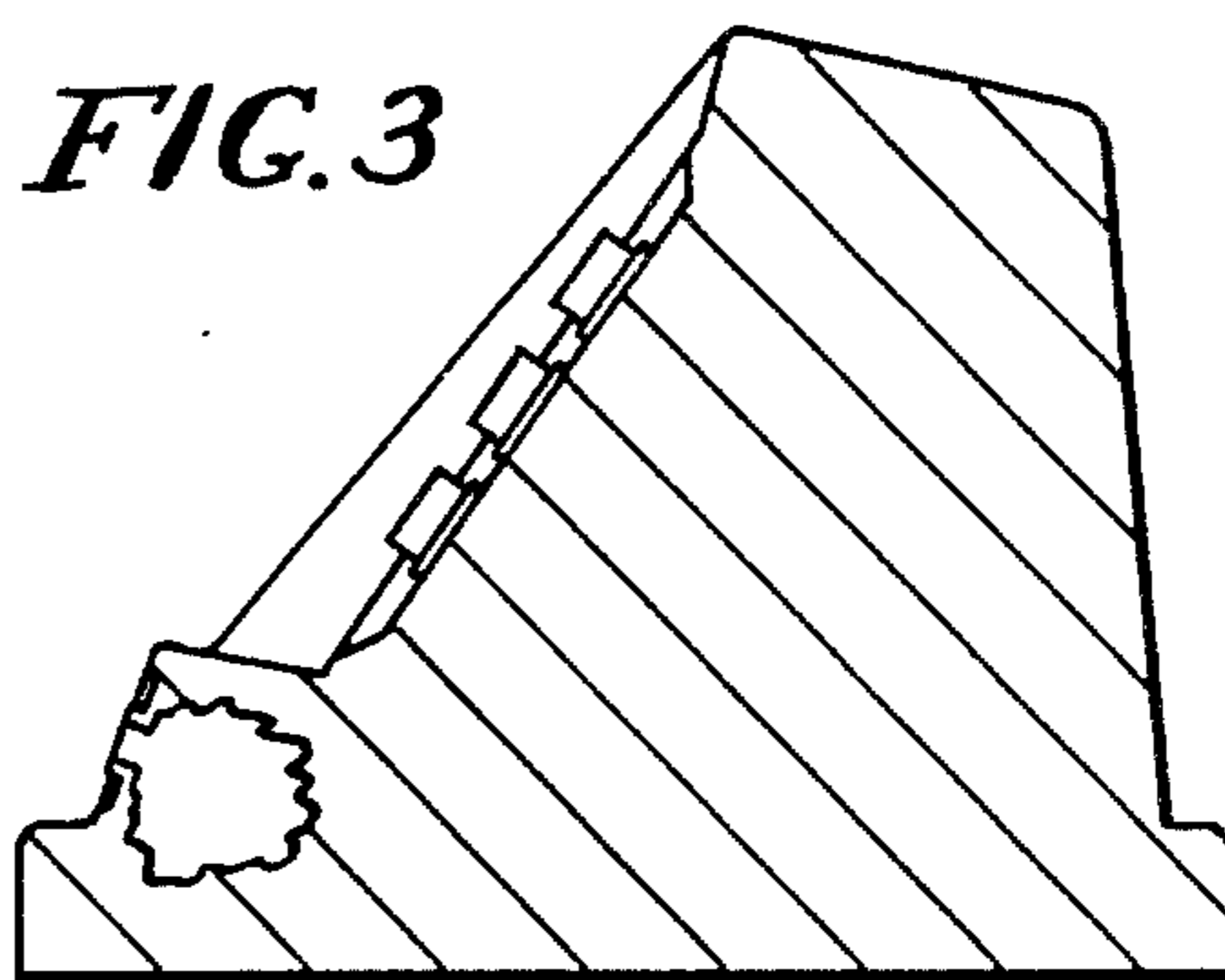

FIG. 3



3 ←

FIG. 4

FIG. 5

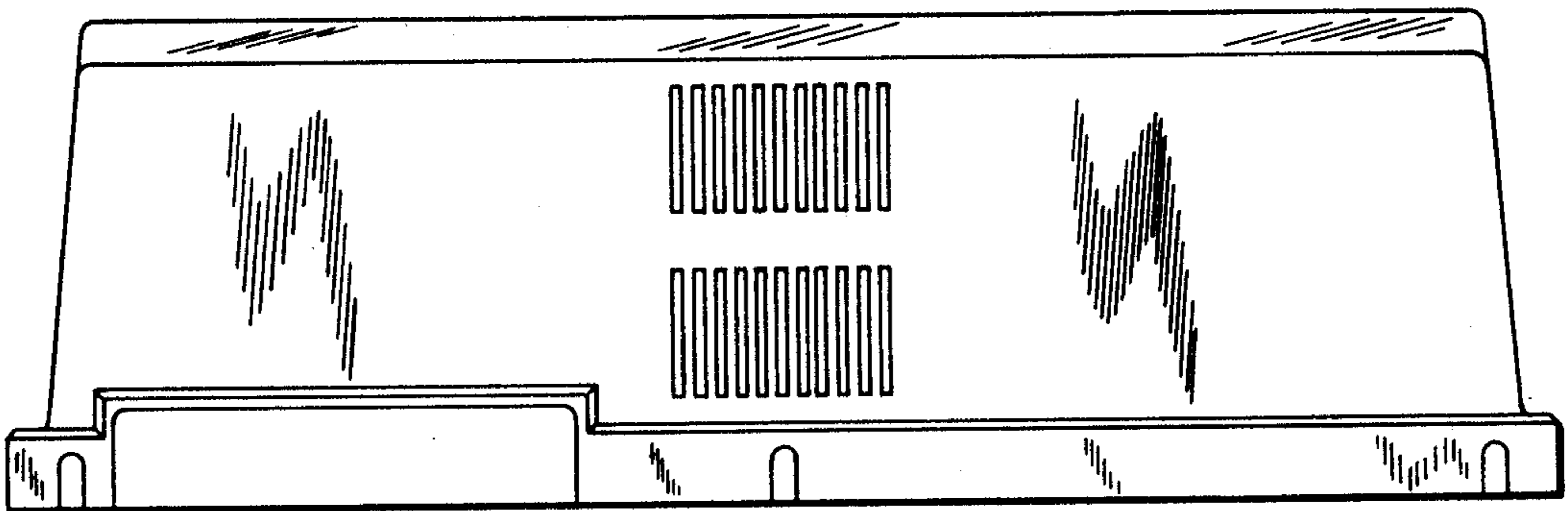
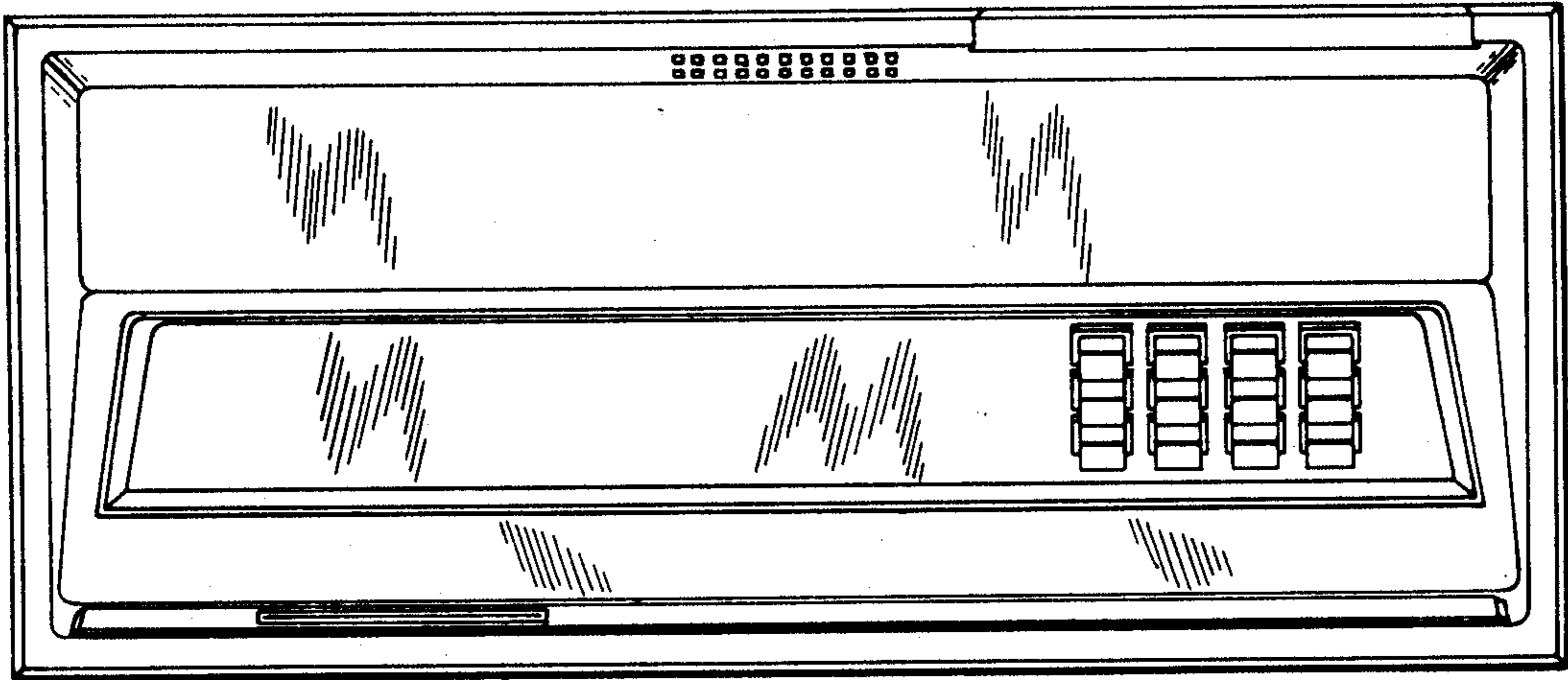

FIG. 6