

[54] BIDET OR SIMILAR ARTICLE

D. 272,382 1/1984 Bengtson D23/51
3,772,710 11/1973 Coutellier 4/443

[75] Inventor: Jack N. Kaiser, Danville, Ky.

Primary Examiner—James R. Largen

[73] Assignee: American Standard, Inc., New York, N.Y.

Attorney, Agent, or Firm—James J. Salerno, Jr.; Robert G. Crooks; John P. Sinnott

[**] Term: 14 Years

[57] CLAIM

[21] Appl. No.: 350,774

The ornamental design for a bidet or similar article, substantially as shown and described.

[22] Filed: Feb. 22, 1982

DESCRIPTION

[52] U.S. Cl. D23/51

[58] Field of Search D23/51, 65-68;
4/420.1, 420.2, 420.3, 420.4, 420.5, 443-448

FIG. 1 is a right side elevational view of a bidet or similar article embodying my new design, the left side being a mirror image of the right side shown;

FIG. 2 is a front elevational view thereof;

FIG. 3 is a top plan view thereof;

FIG. 4 is a rear elevational view thereof;

FIG. 5 is a bottom plan view thereof;

FIG. 6 is a cross sectional view taken on line 6-6 of FIG. 3; and

FIG. 7 is a cross sectional view taken on line 7-7 of FIG. 3.

[56] References Cited

U.S. PATENT DOCUMENTS

D. 183,039	6/1958	Dreyfuss	D23/51
D. 226,910	5/1973	Doman	D23/51
D. 256,609	8/1980	Primault	D23/51
D. 261,797	11/1981	Kaiser	D23/51
D. 268,779	4/1983	Doman	D23/51

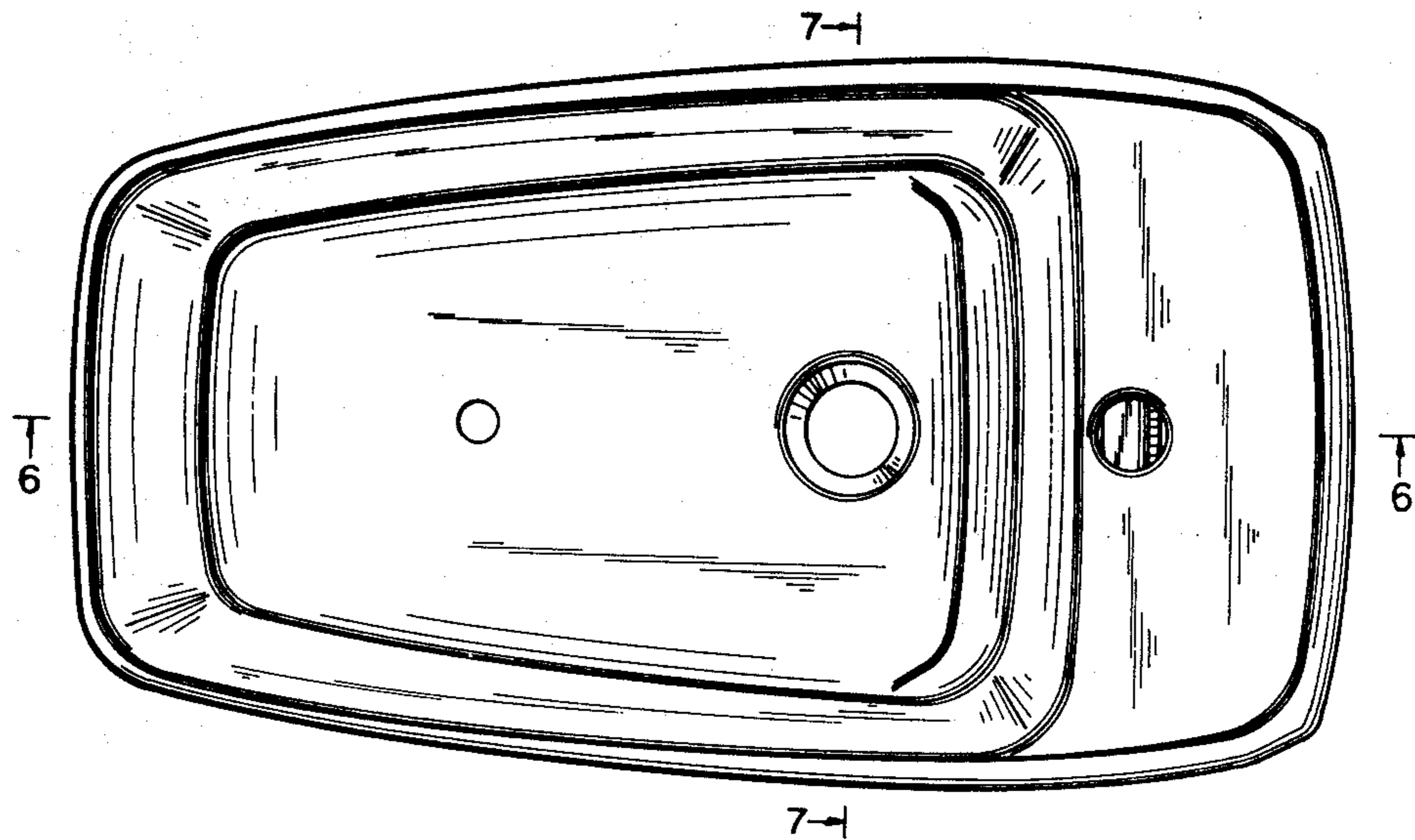
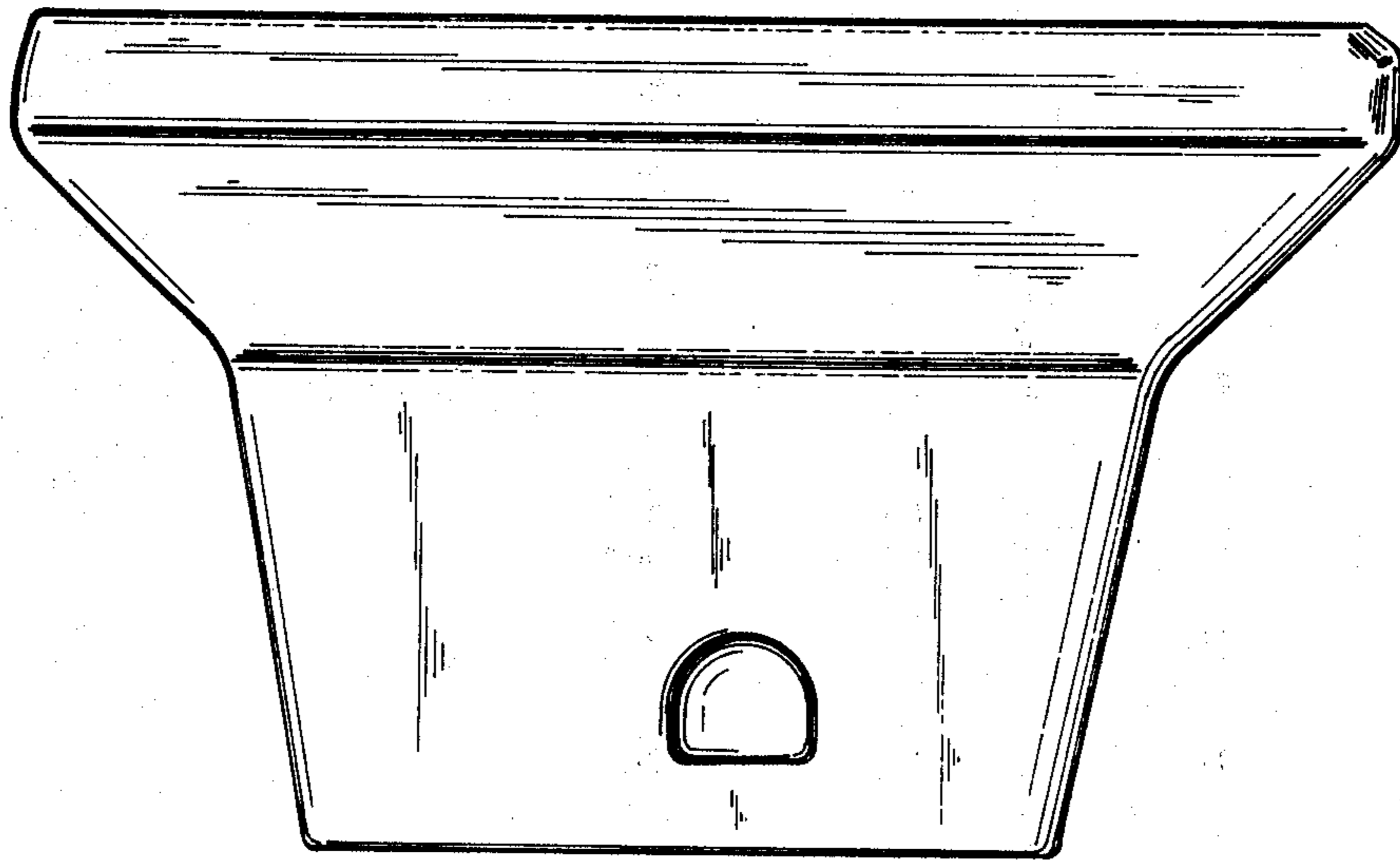

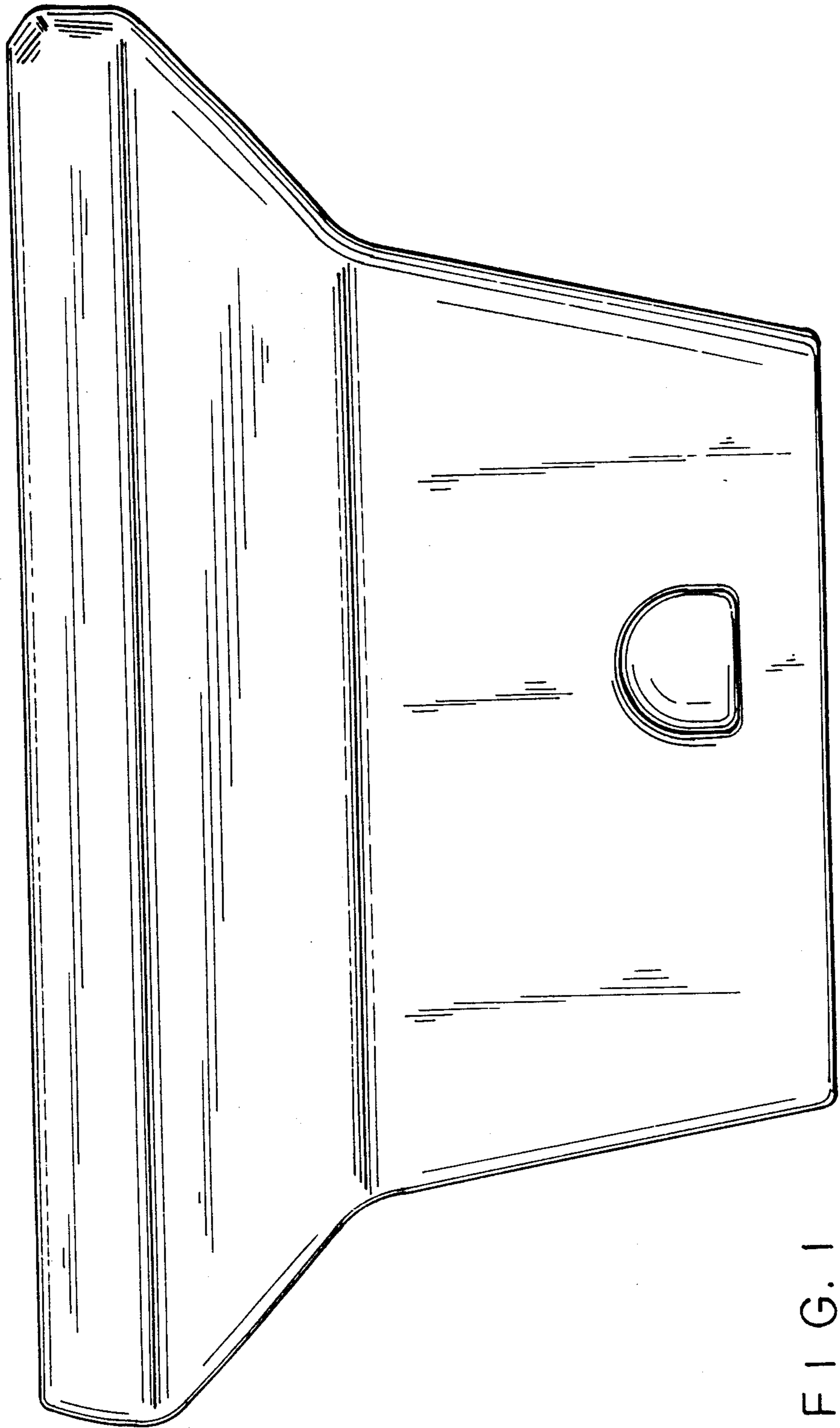
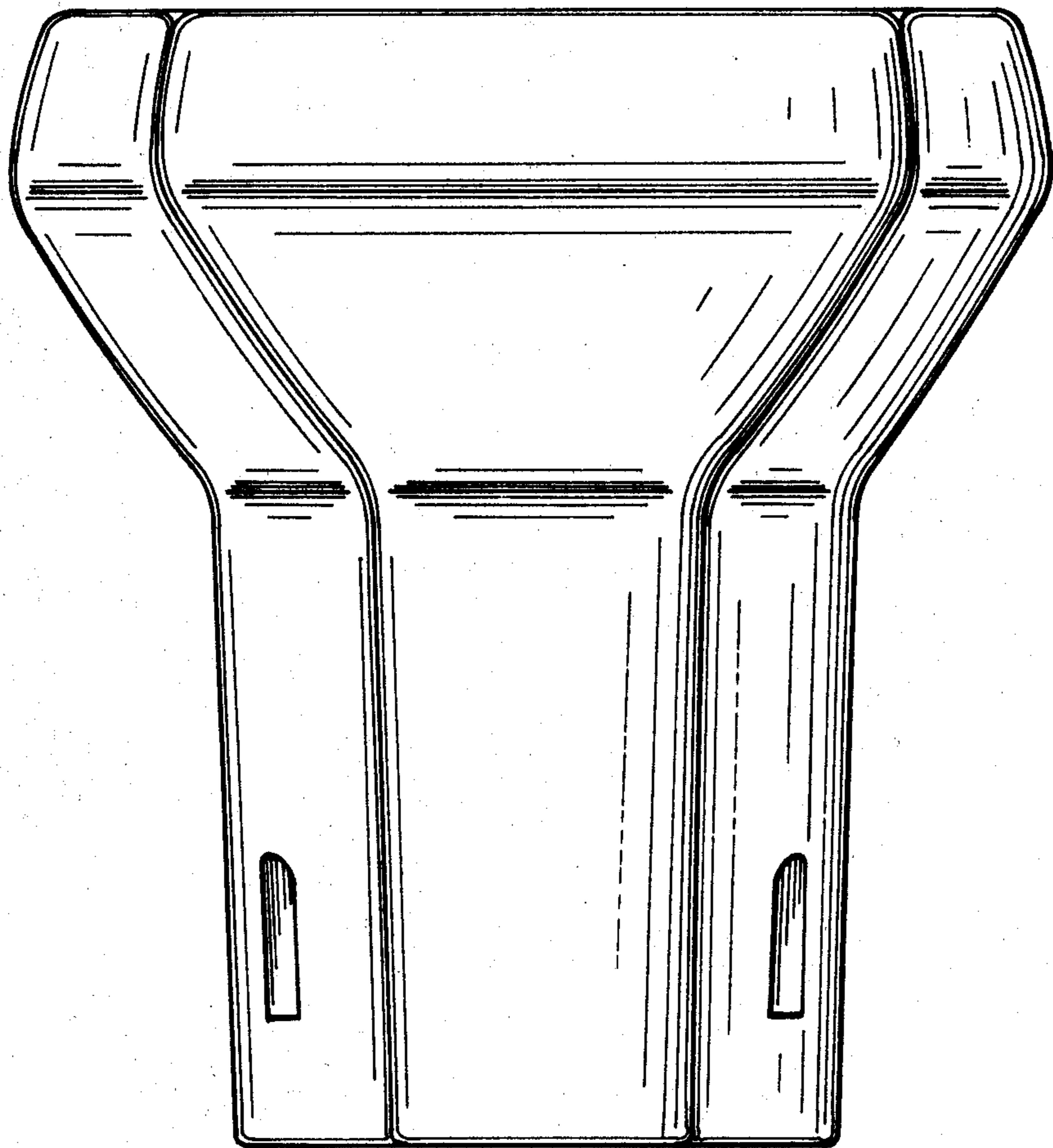

FIG. 1

FIG. 2



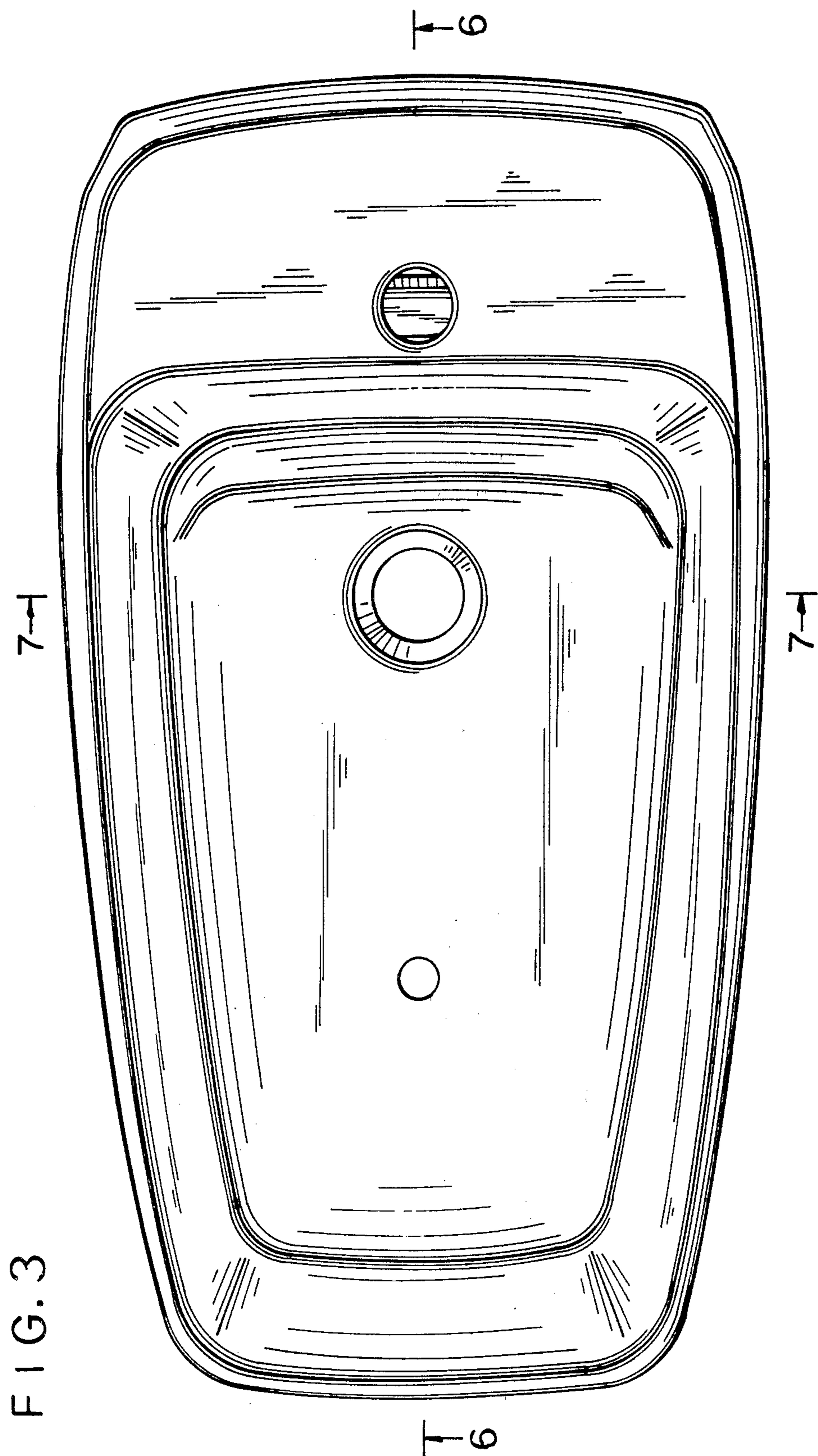
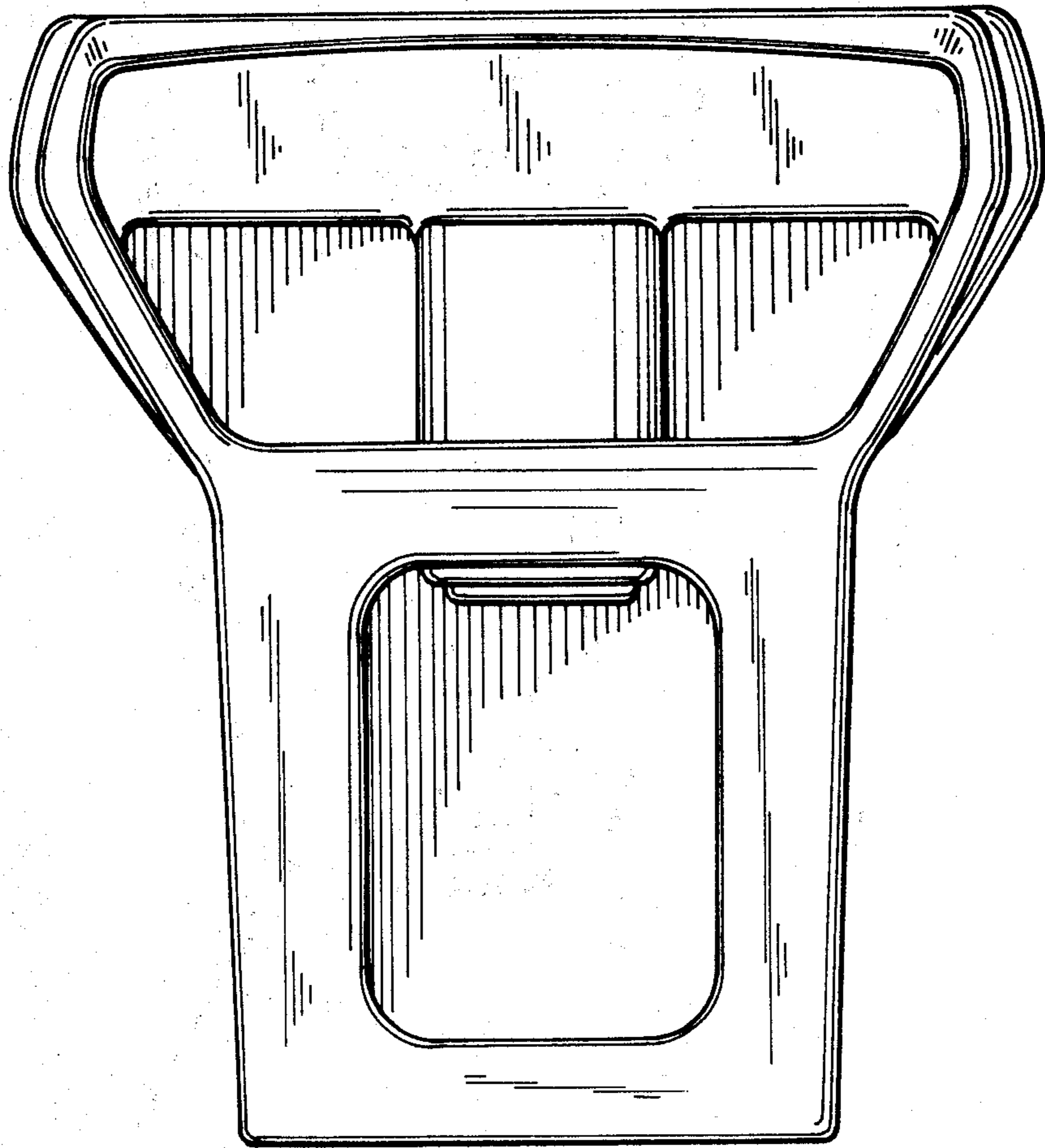

FIG. 4



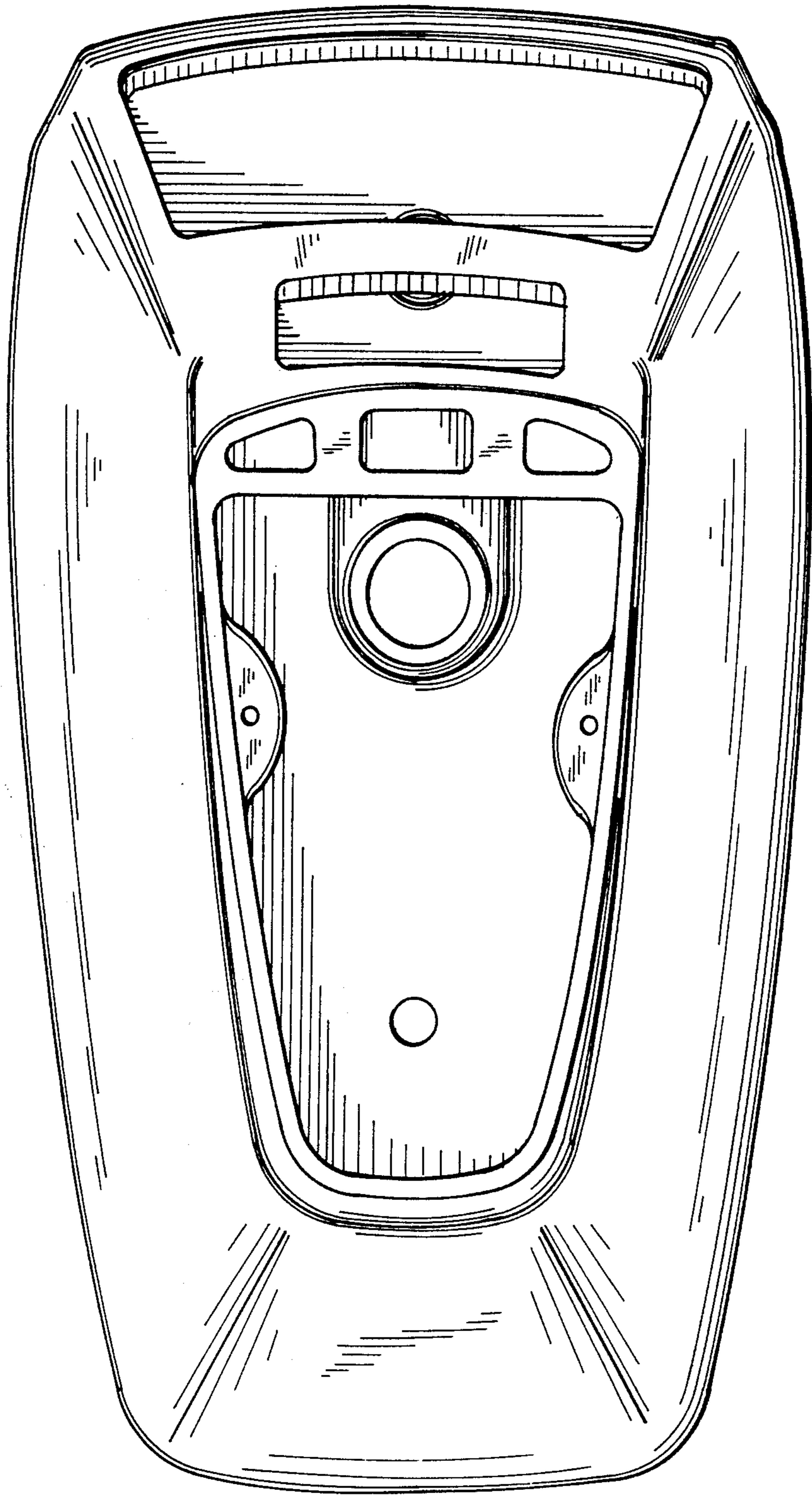

FIG. 5

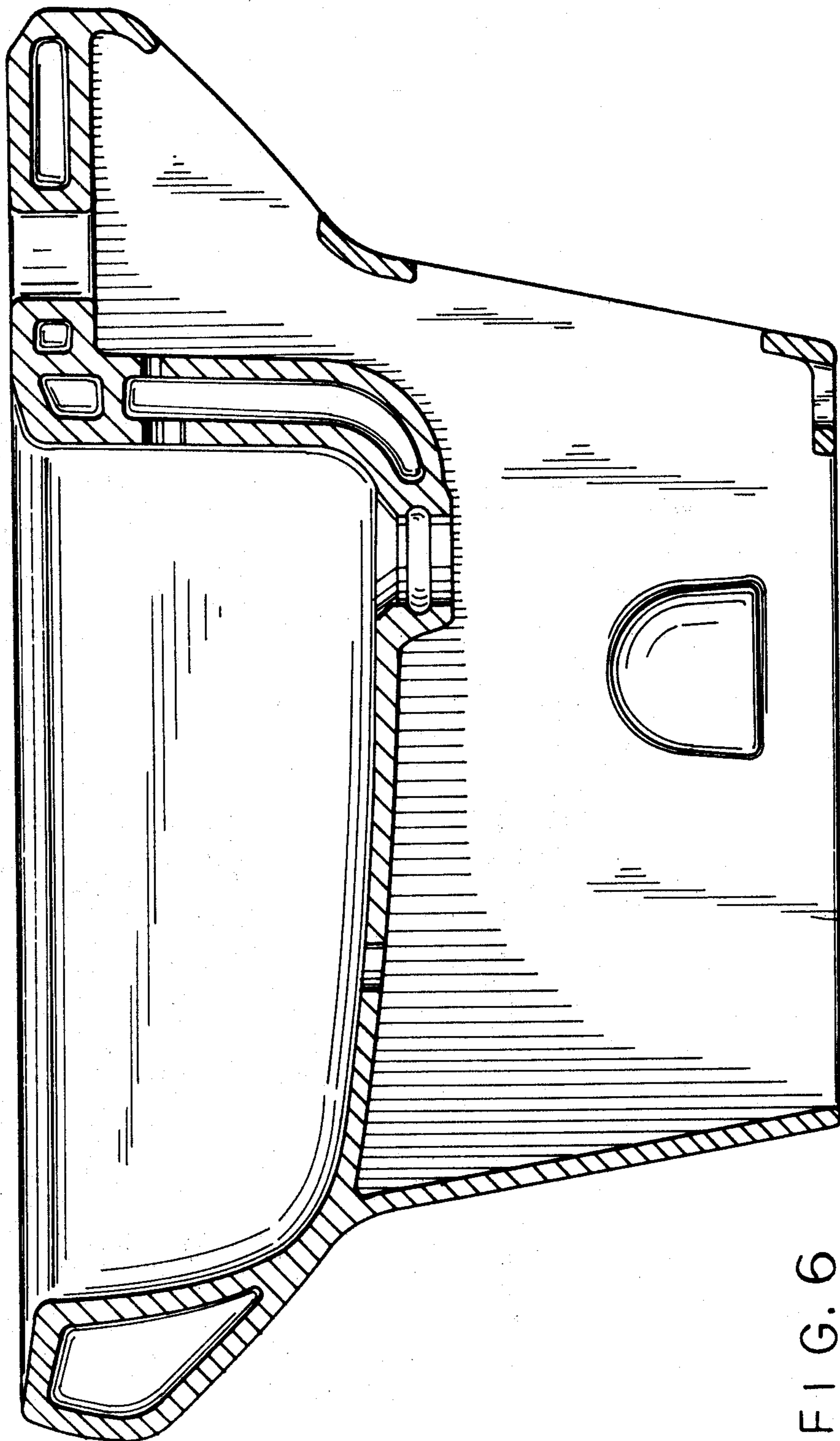

FIG. 6

FIG. 7

