

[54] ICE SKATE

[76] Inventor: George Couture, Quebec City, Prov. of Quebec, Canada

[**] Term: 14 Years

[21] Appl. No.: 350,962

[22] Filed: Feb. 22, 1982

[30] Foreign Application Priority Data

Aug. 28, 1981 [CA] Canada 28-08-81-2

[52] U.S. Cl. D21/225

[58] Field of Search D21/225; 280/11.12, 280/11.17, 11.18

[56] References Cited

FOREIGN PATENT DOCUMENTS

| | | | |
|--------|--------|--------------|-----------|
| 463164 | 2/1950 | Canada | 280/11.12 |
| 47247 | 8/1980 | Canada | 280/11.12 |
| 171544 | 3/1960 | Sweden | 280/11.12 |

Primary Examiner—Melvin B. Feifer
Attorney, Agent, or Firm—Beveridge, DeGrandi & Kline

[57] CLAIM

The ornamental design for an ice skate, as shown and described.

DESCRIPTION

FIG. 1 is a perspective view of an ice skate showing my new design;

FIG. 2 is a plan view;

FIG. 3 is a side view;

FIG. 4 is a bottom view;

FIG. 5 is a front view; and

FIG. 6 is a rear view.

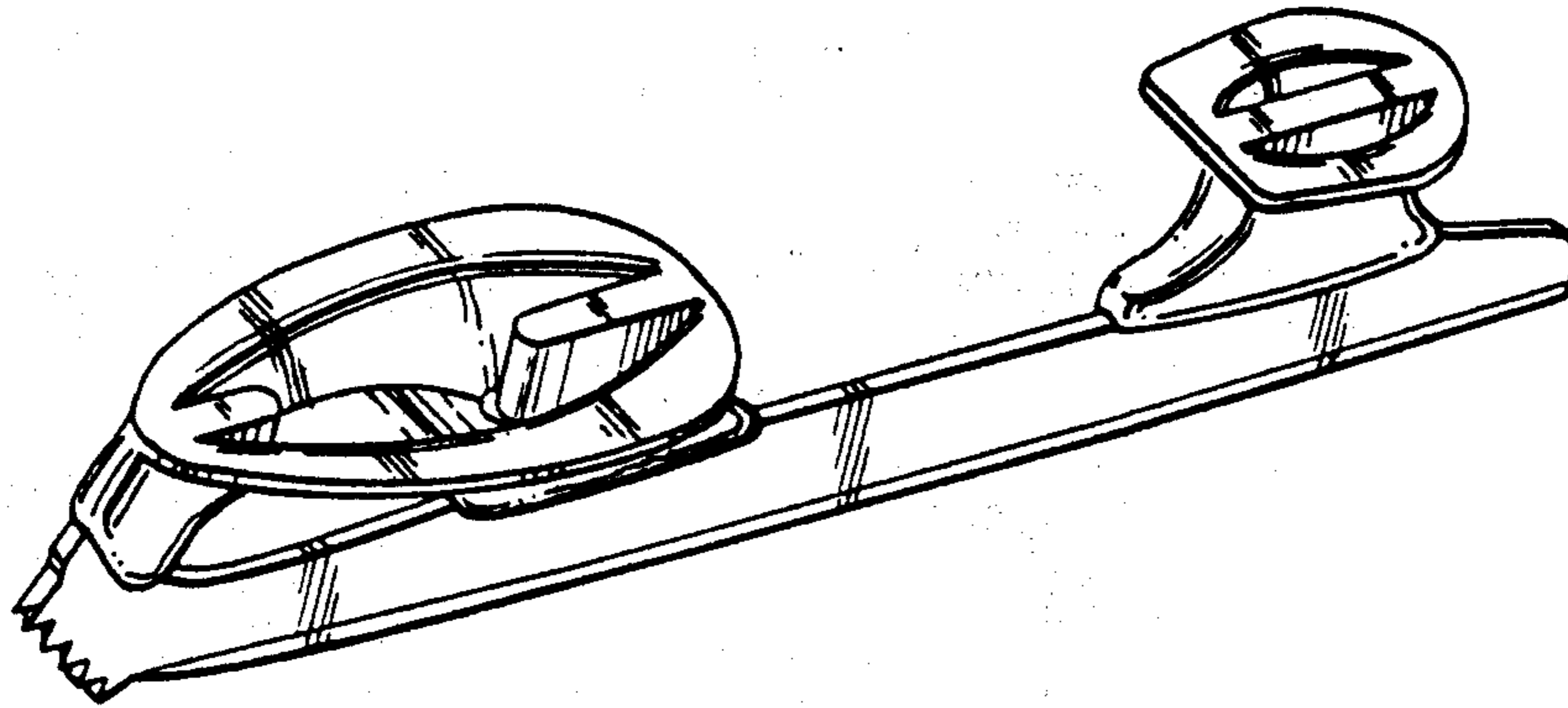

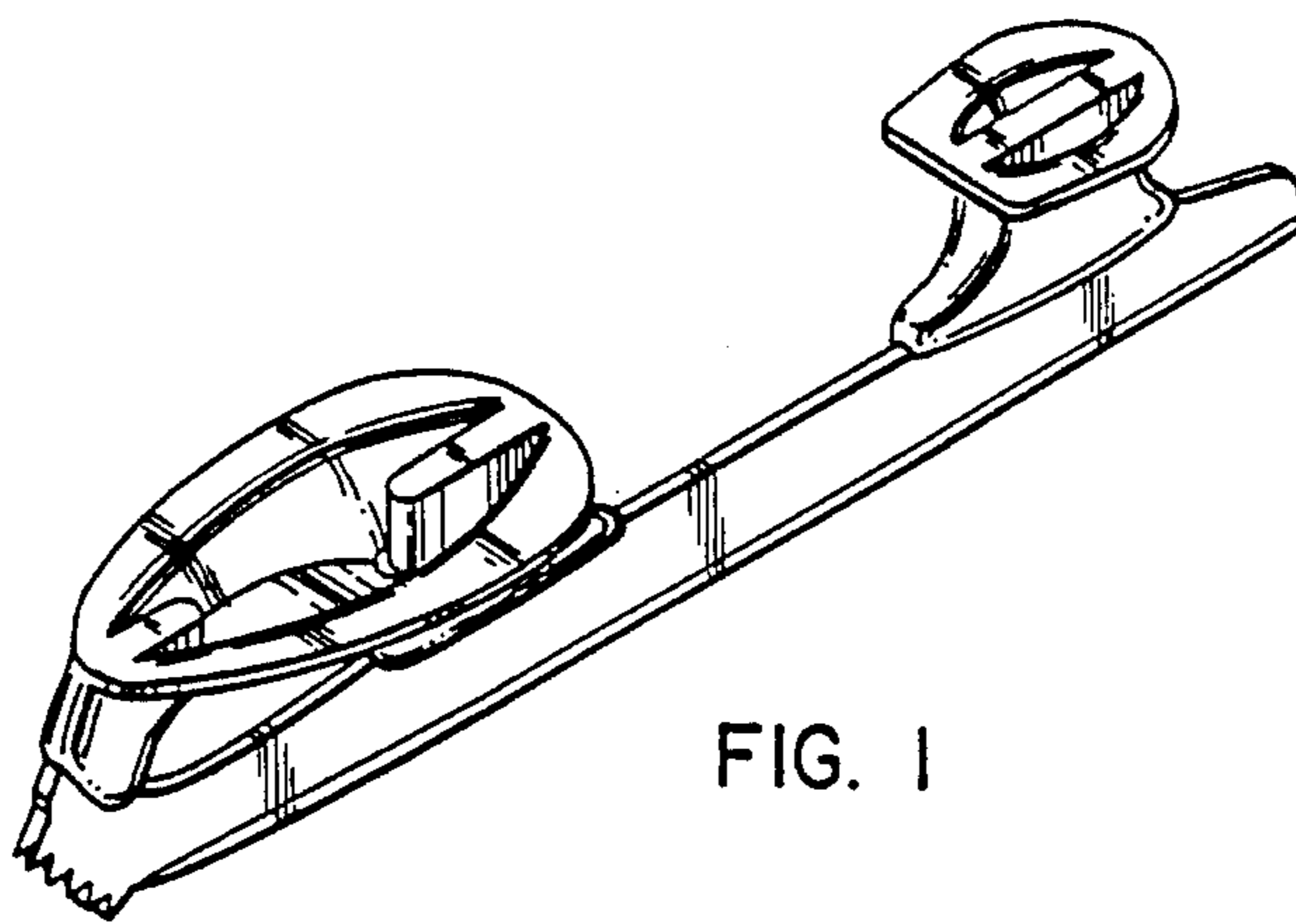

FIG. 1

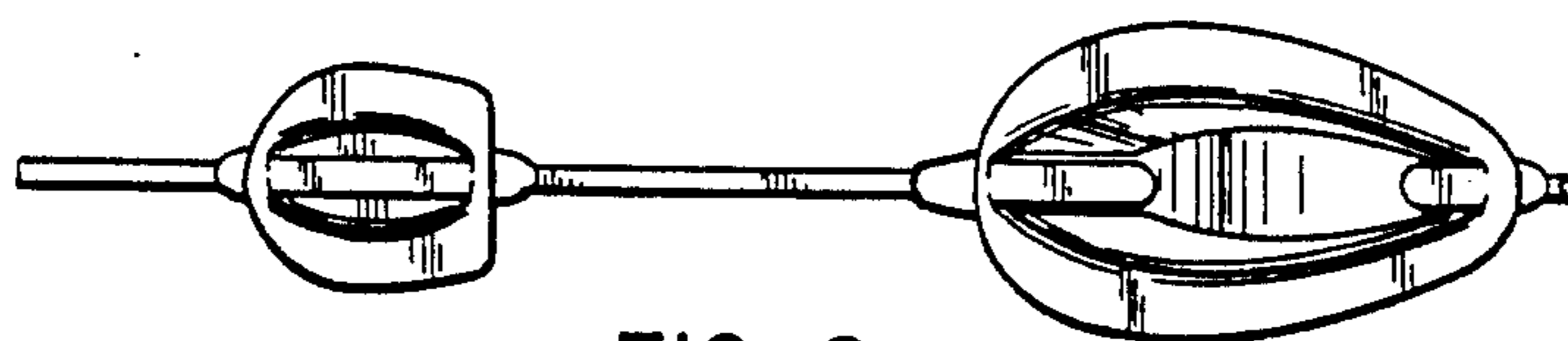

FIG. 2

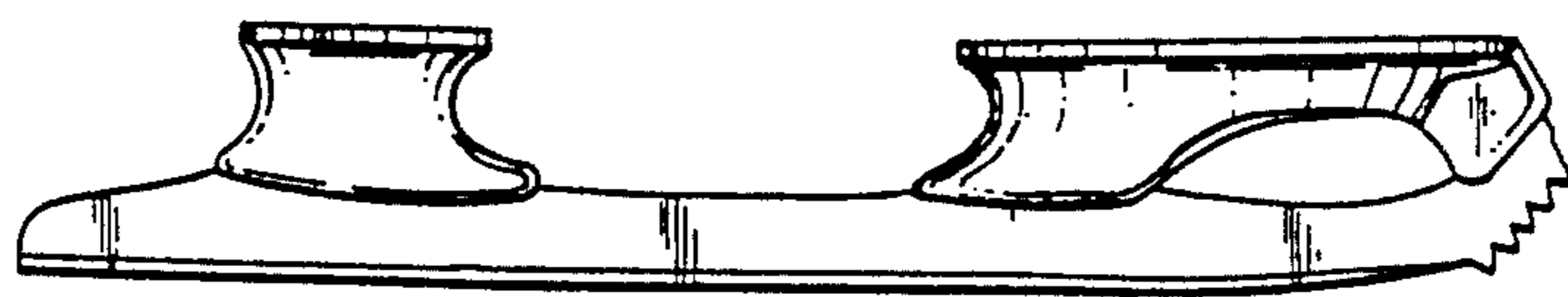

FIG. 3

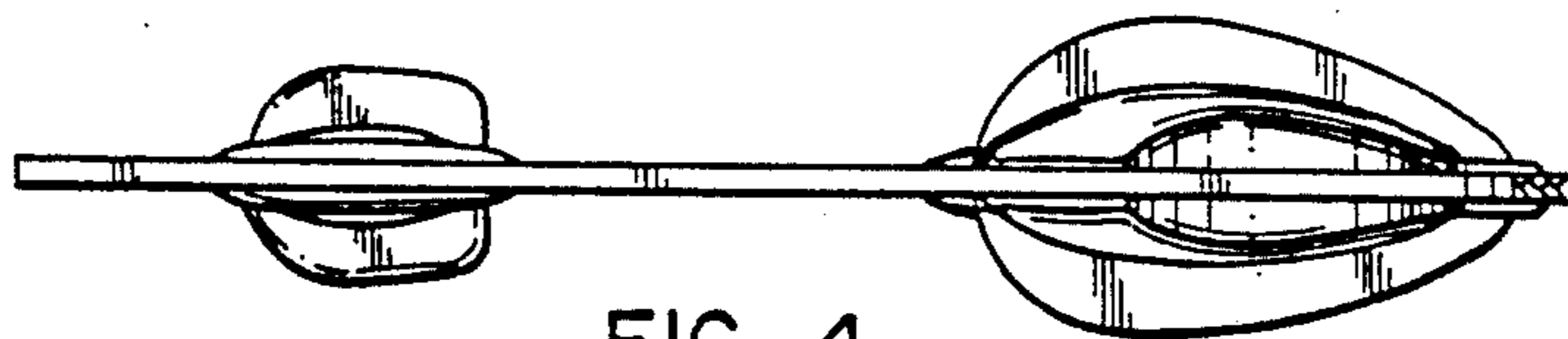

FIG. 4

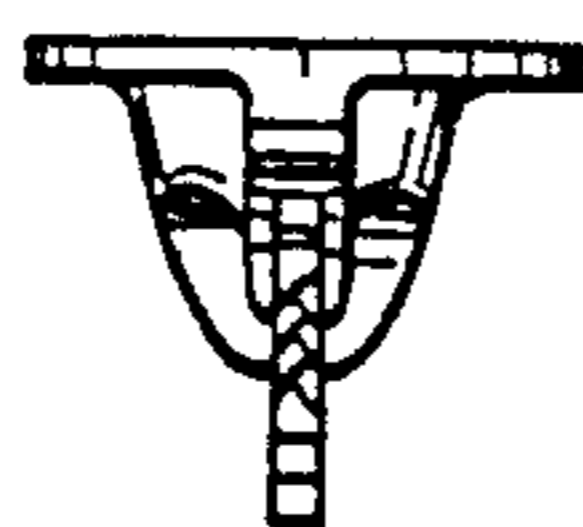

FIG. 5

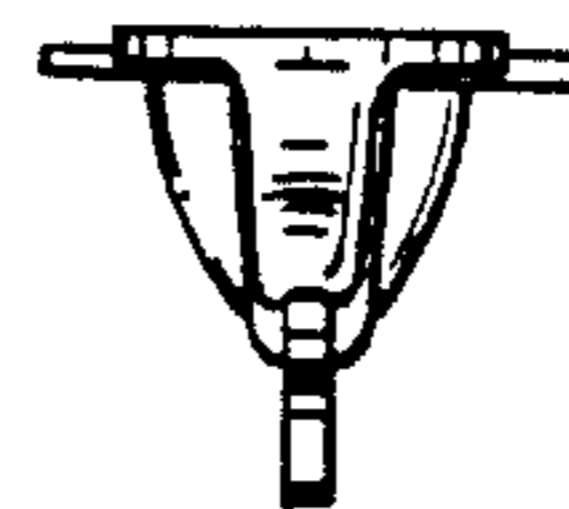

FIG. 6