

[54] POCKET CASE FOR A DICE GAME

[76] Inventor: Nicolaas Neuwahl, via della  
Martellina 25, Bagno a Ripoli  
(Firenze), Italy

[\*\*] Term: 14 Years

[21] Appl. No.: 321,100

[22] Filed: Nov. 13, 1981

[52] U.S. Cl. .... D21/37; D21/15;  
D21/16; D21/41

[58] Field of Search ..... D21/15, 16, 37, 41,  
D21/21, 54; 273/268; D9/347

[56] References Cited

U.S. PATENT DOCUMENTS

648,814 5/1900 Trewartha ..... D21/54  
2,253,605 8/1941 Bloom ..... 273/268

FOREIGN PATENT DOCUMENTS

304440 1/1929 United Kingdom ..... 273/268

Primary Examiner—Melvin B. Feifer

Attorney, Agent, or Firm—McAulay, Fields, Fisher,  
Goldstein & Nissen

[57] CLAIM

The ornamental design for a pocket case for a dice game, as shown and described.

DESCRIPTION

FIG. 1 is a front perspective view of the pocket case for a dice game in its closed condition showing my new design;

FIG. 2 is a top view thereof;

FIG. 3 is a bottom view thereof;

FIG. 4 is a front view thereof;

FIG. 5 is a rear view thereof;

FIG. 6 is a left side view thereof, and the right side view is a mirror image of the left side view;

FIG. 7 is a top perspective view of the pocket case for a dice game in open position;

FIG. 8 is another perspective view of the pocket case for a dice game; and

FIG. 9 is a top plan view of another embodiment thereof.

The broken line showing of dice in FIGS. 8 and 9 are for illustrative purposes only.

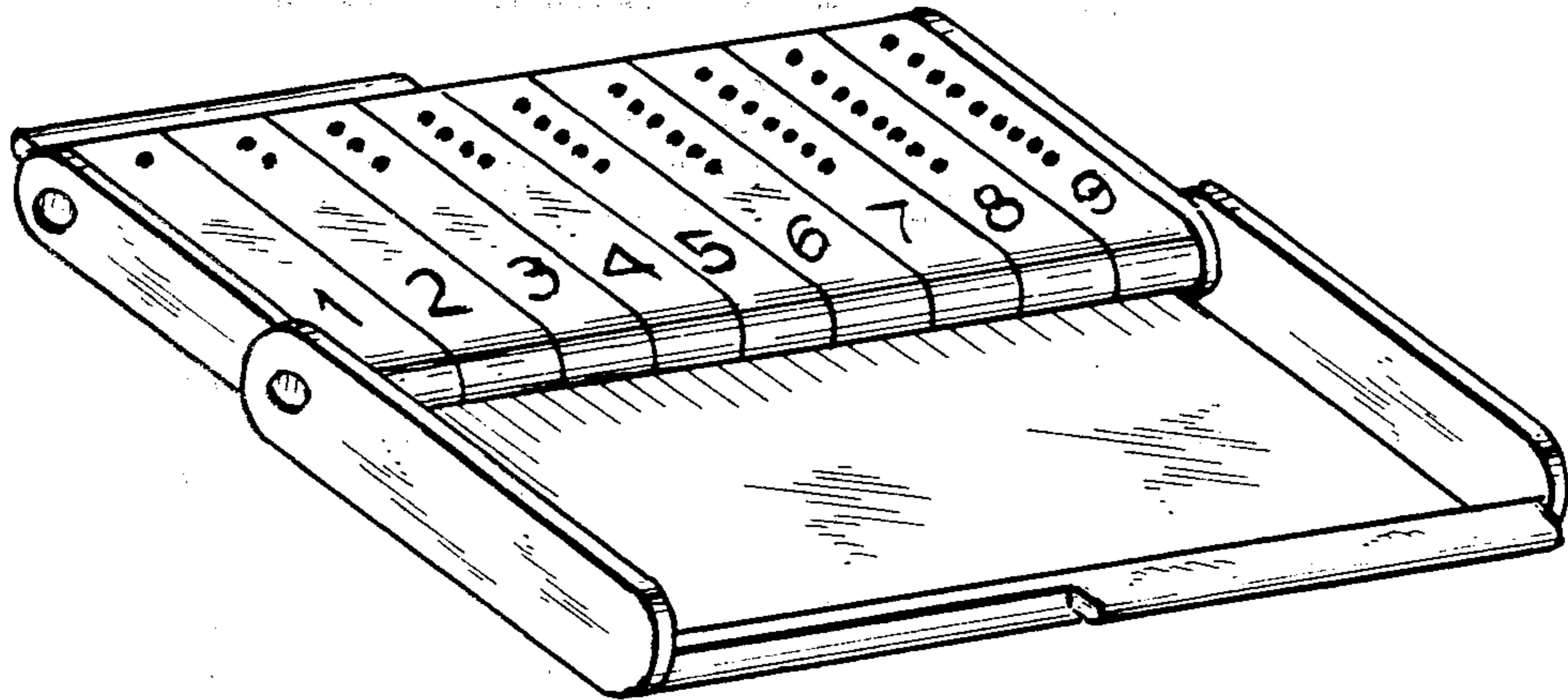

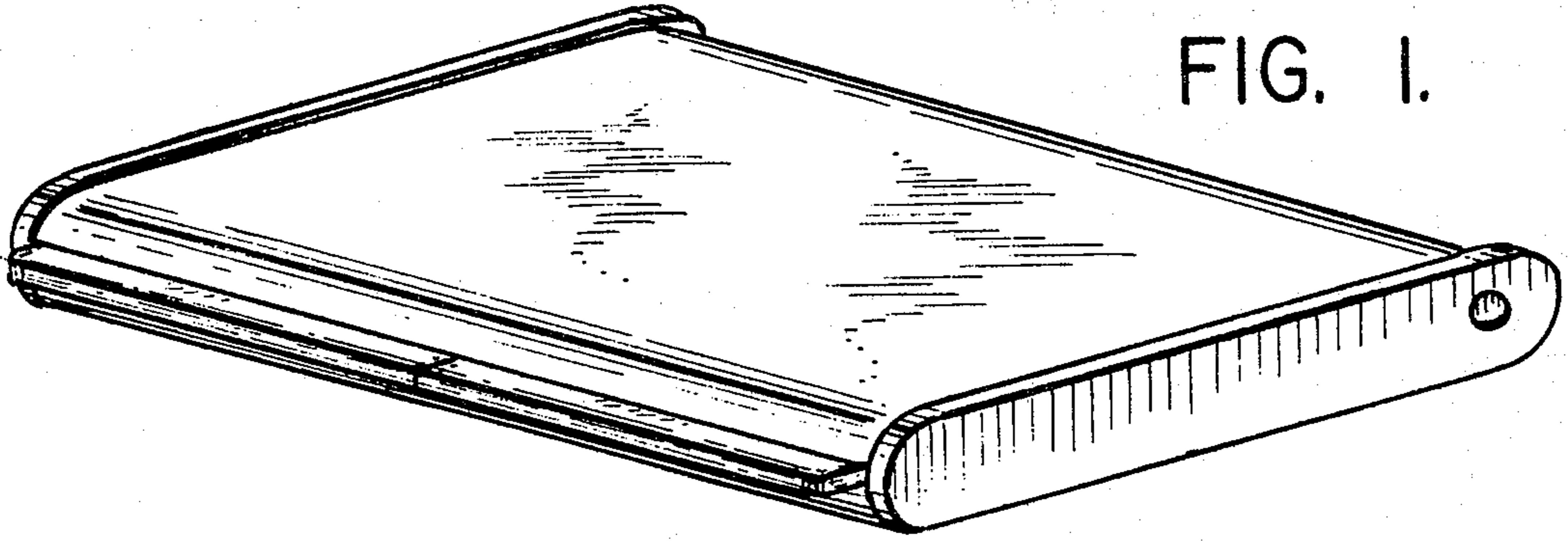

FIG. 1.

FIG. 2.

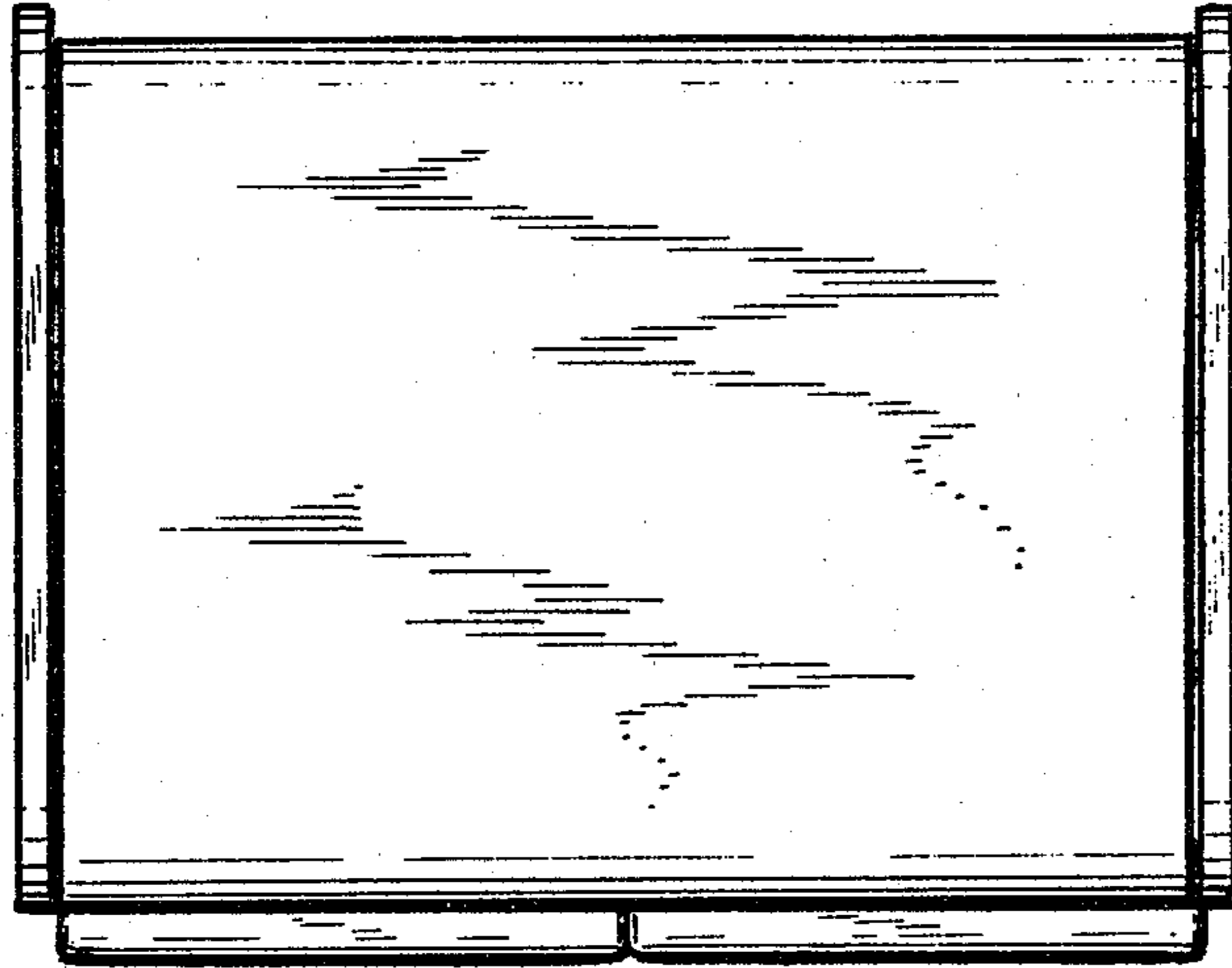

FIG. 3.

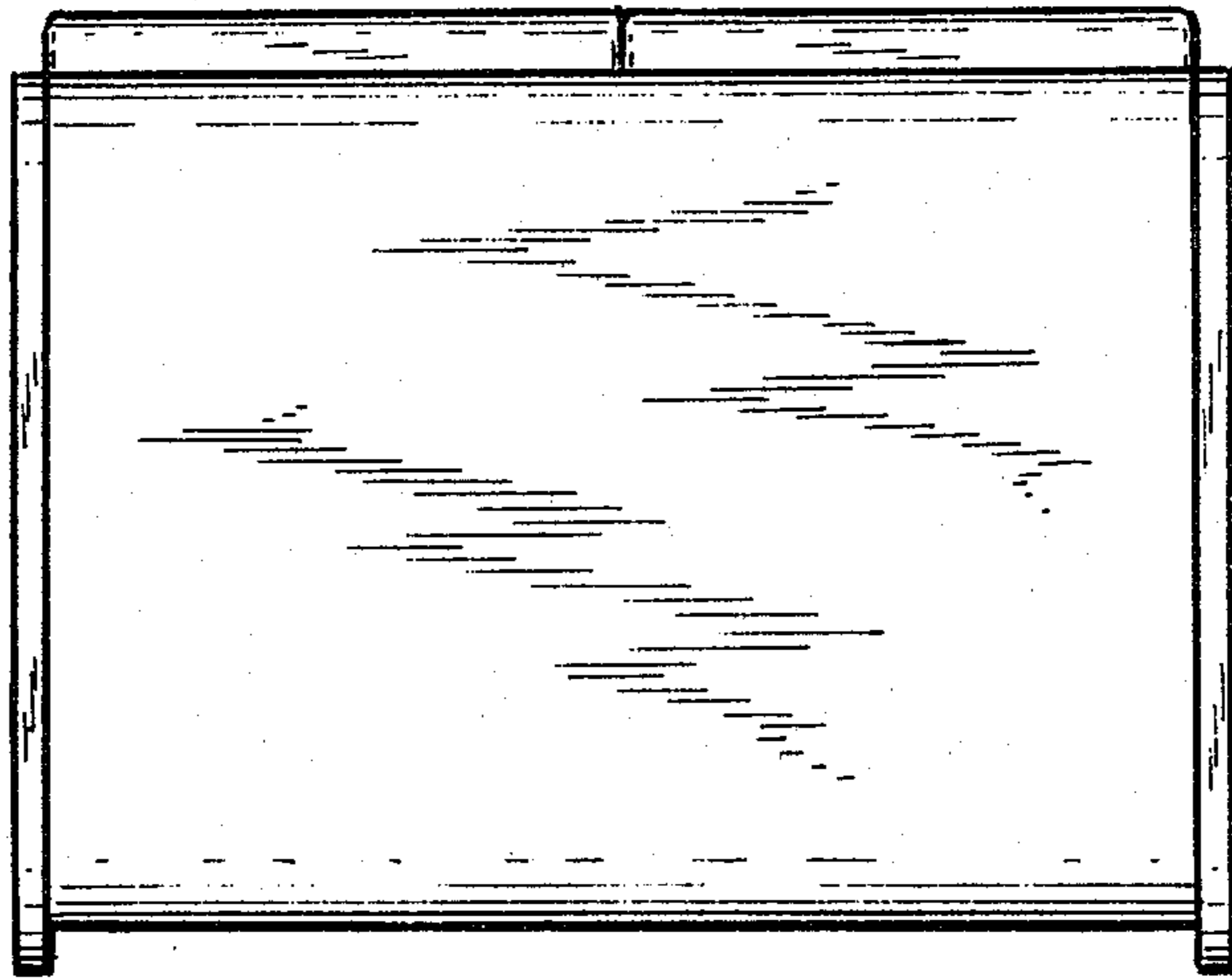

FIG. 4.

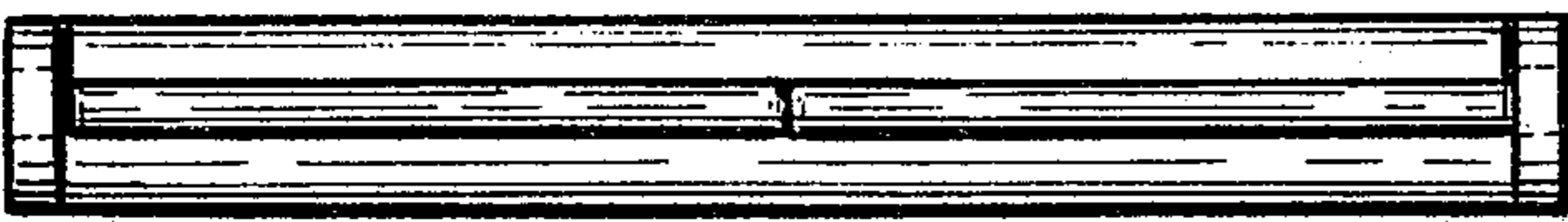

FIG. 5.

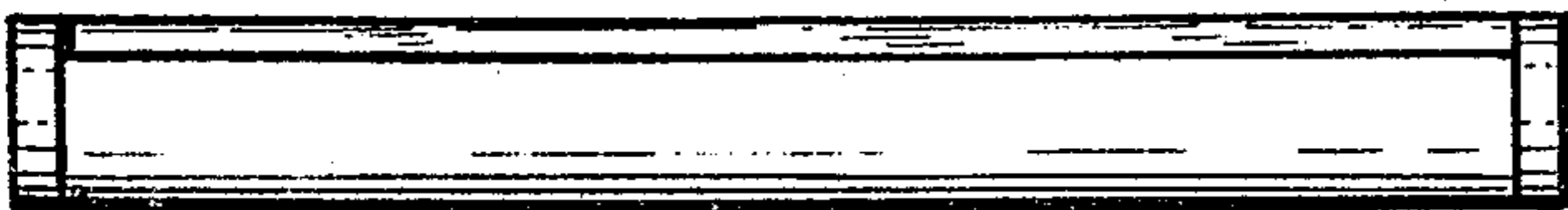
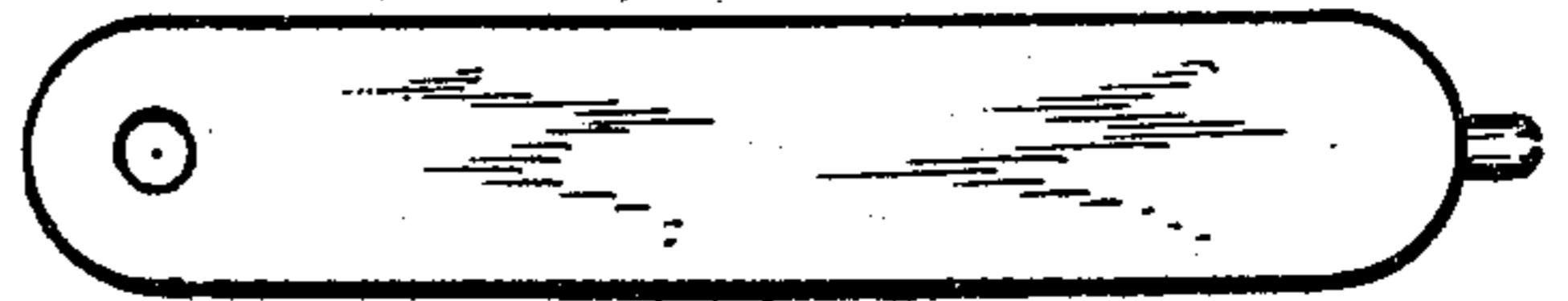

FIG. 6.



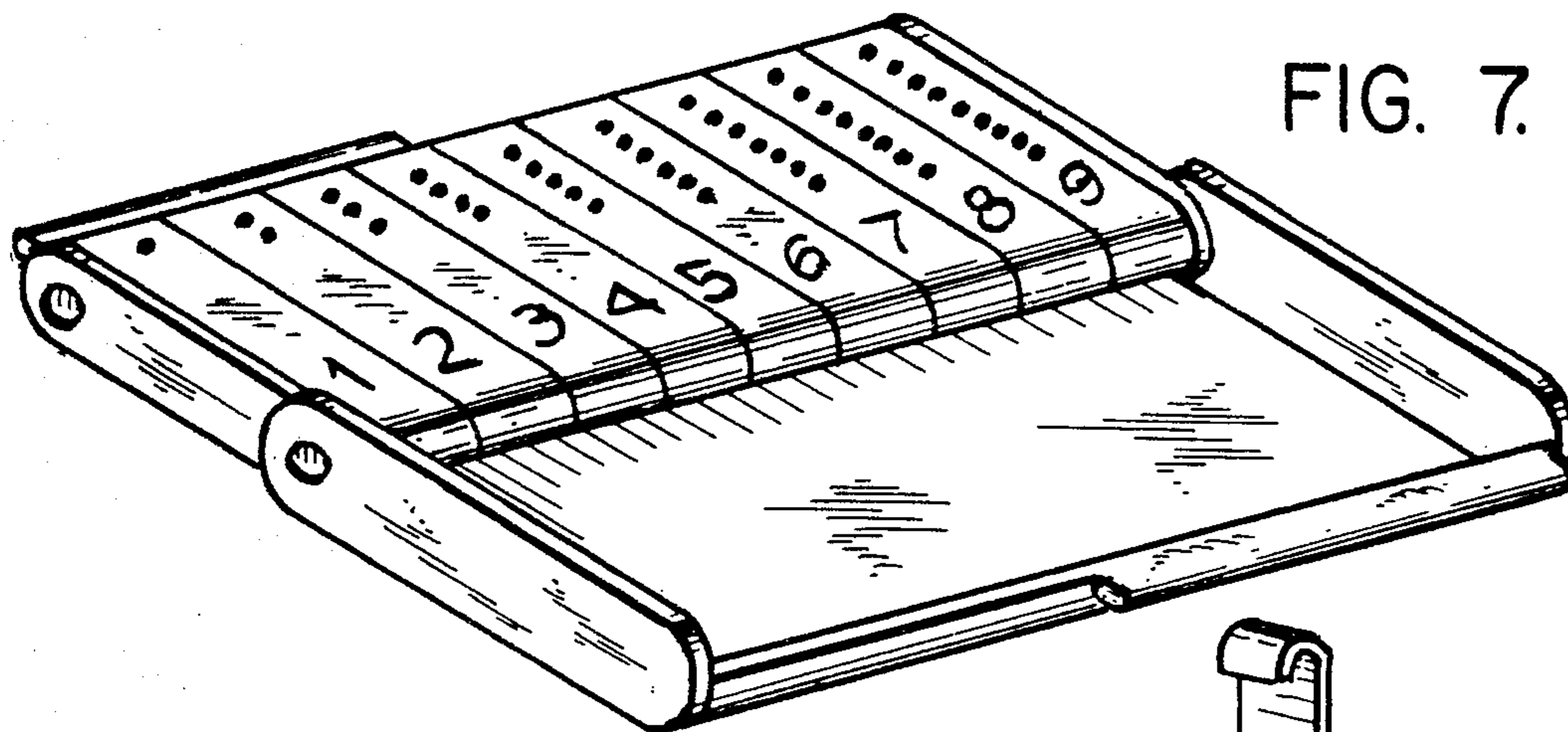

FIG. 8.

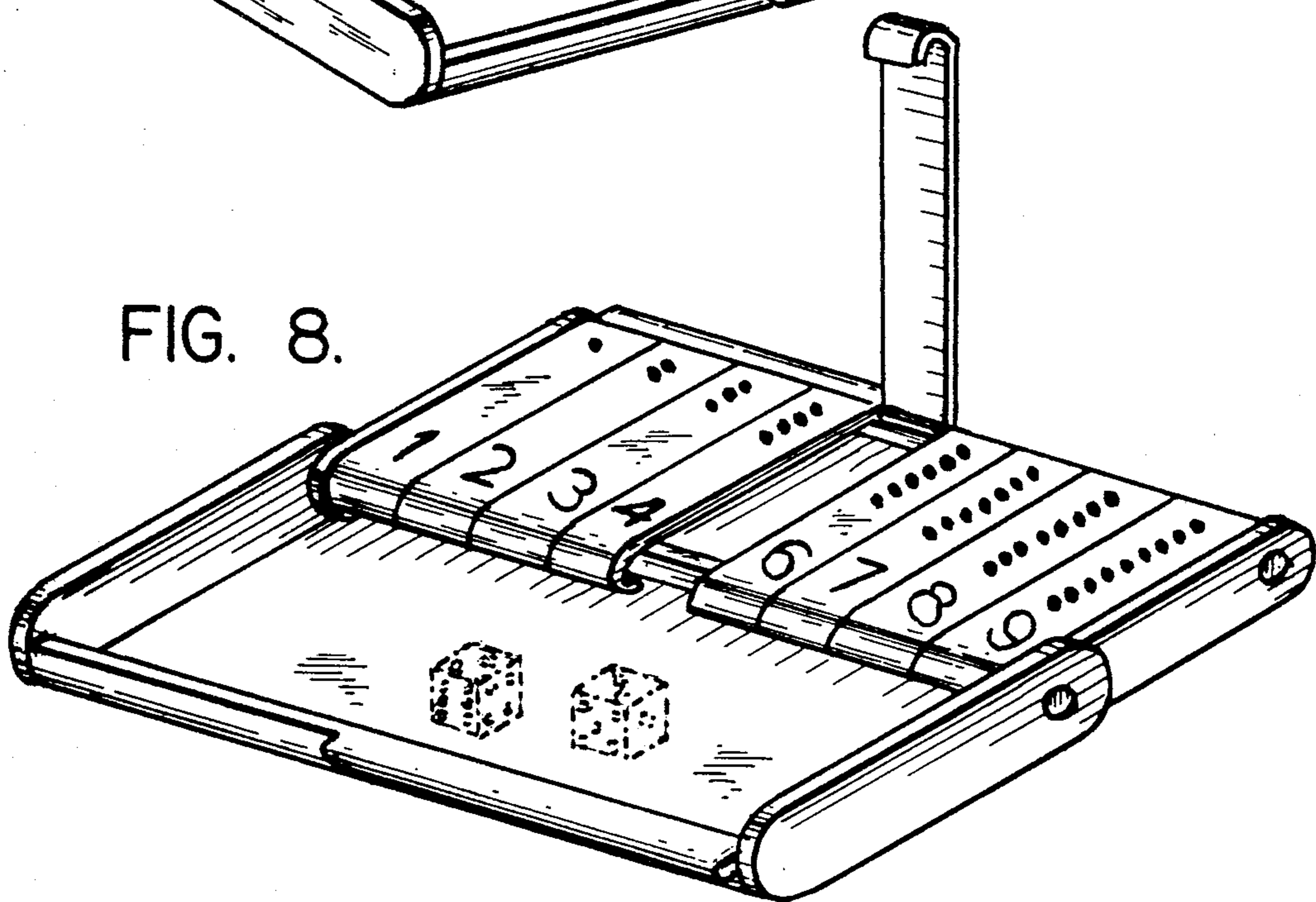

FIG. 9.

