

United States Patent [19]

Zabel et al.

[11] Patent Number: Des. 274,497

[45] Date of Patent: ** Jul. 3, 1984

[54] KNIFE SHARPENER

[75] Inventors: Herert E. Zabel, Wheaton; Casimir Gruska, Park Ridge, both of Ill.

[73] Assignee: American Home Products Corporation, New York, N.Y.

[**] Term: 14 Years

[21] Appl. No.: 351,191

[22] Filed: Feb. 22, 1982

[52] U.S. Cl. D8/93

[58] Field of Search D8/93; 76/87

[56] **References Cited**

U.S. PATENT DOCUMENTS

D. 145,803	10/1946	Jones	D8/93
1,919,772	7/1933	Carpenter	76/87
2,765,680	10/1956	Murchison	76/86
3,289,498	12/1966	Pleasants	D8/93 X

FOREIGN PATENT DOCUMENTS

534112	12/1921	France	76/87
--------	---------	--------	-------	-------

44508	8/1916	Sweden	76/87
137430	1/1920	United Kingdom	76/87

Primary Examiner—Alan P. Douglas
Attorney, Agent, or Firm—Robert D. Teichert

[57] **CLAIM**

The ornamental design for a knife sharpener, as shown.

DESCRIPTION

FIG. 1 is a top plan view of a knife sharpener showing our new design.

FIG. 2 is a right side elevational view thereof.

FIG. 3 is a bottom plan view thereof.

FIG. 4 is a left side elevational view thereof.

FIG. 5 is an end elevational view taken from line 5—5 of FIG. 1.

FIG. 6 is a sectional view taken along line 6—6 of FIG. 3.

FIG. 7 is an end elevational view taken from line 7—7 of FIG. 3.

FIG. 8 is a sectional view taken along line 8—8 of FIG. 1.

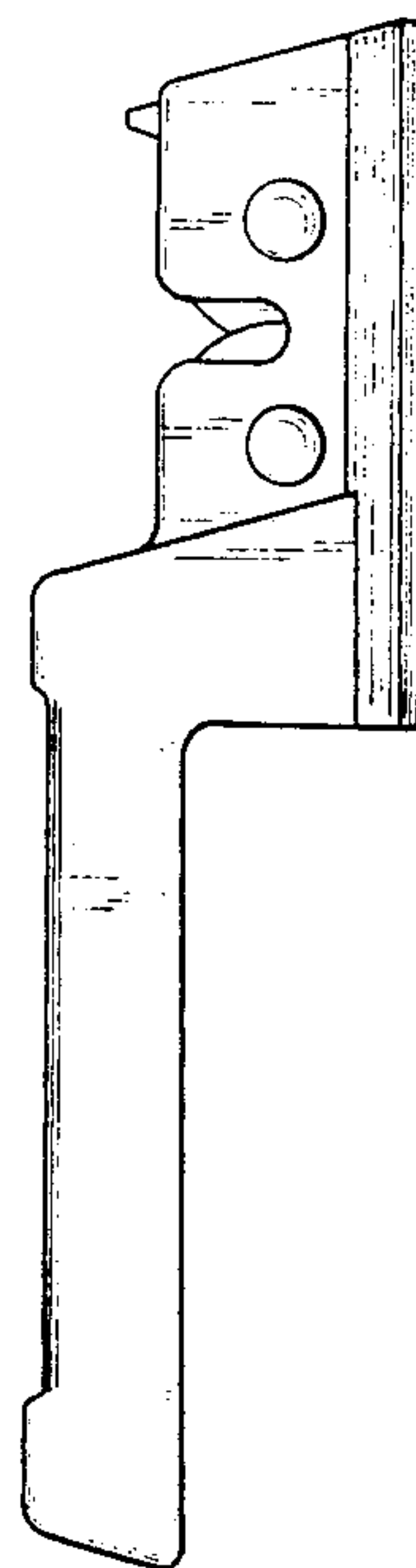
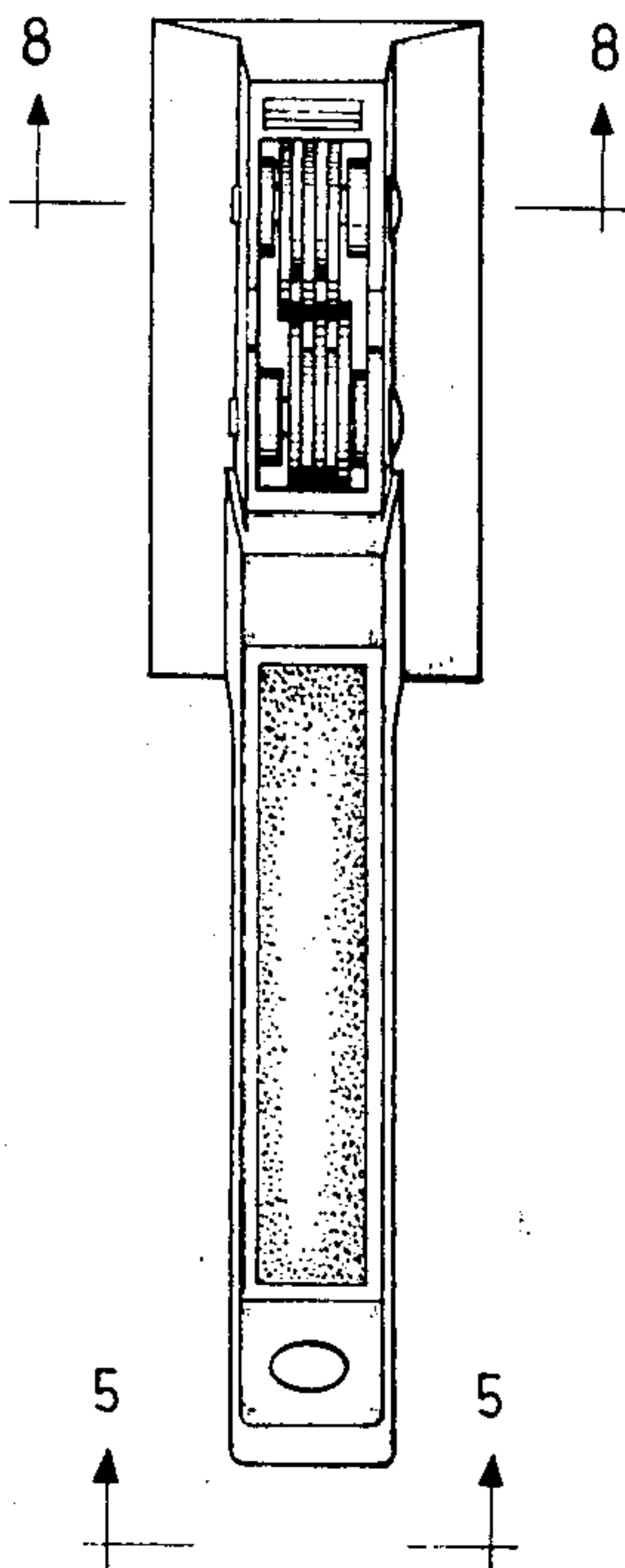

FIG. 1

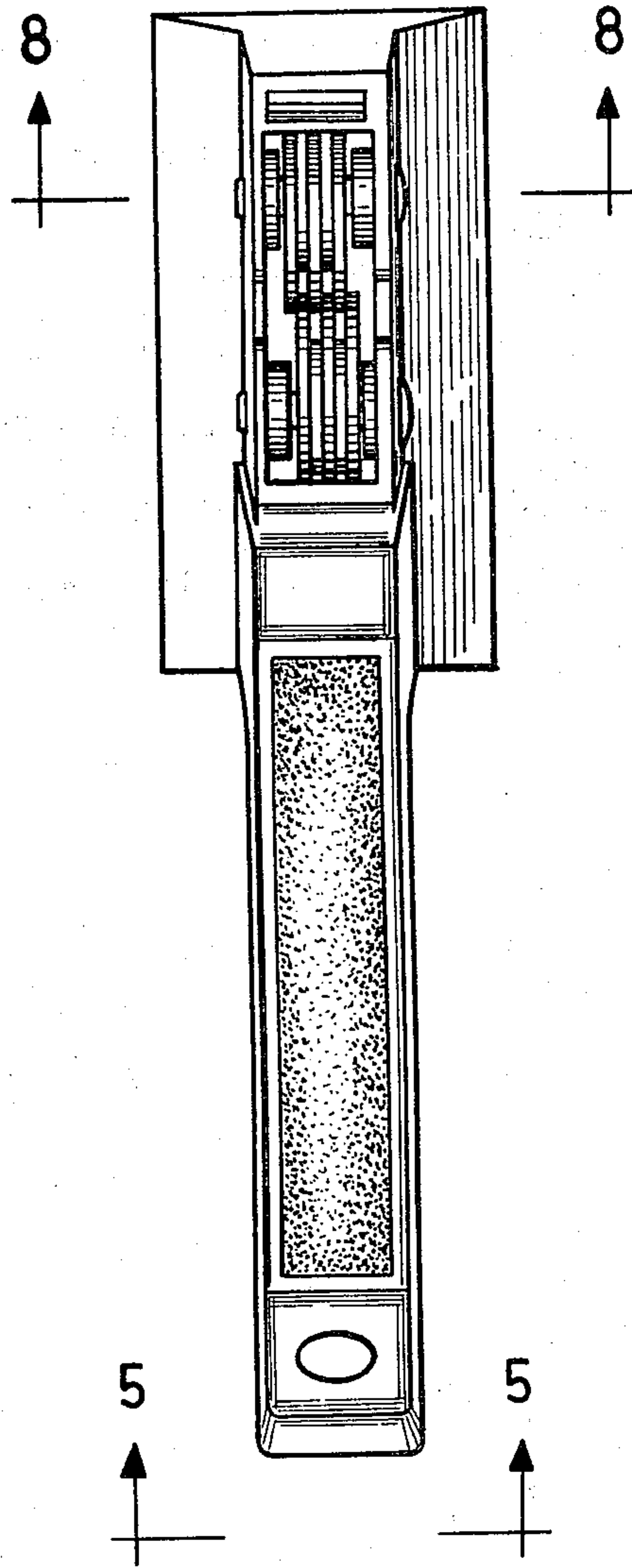

FIG. 2

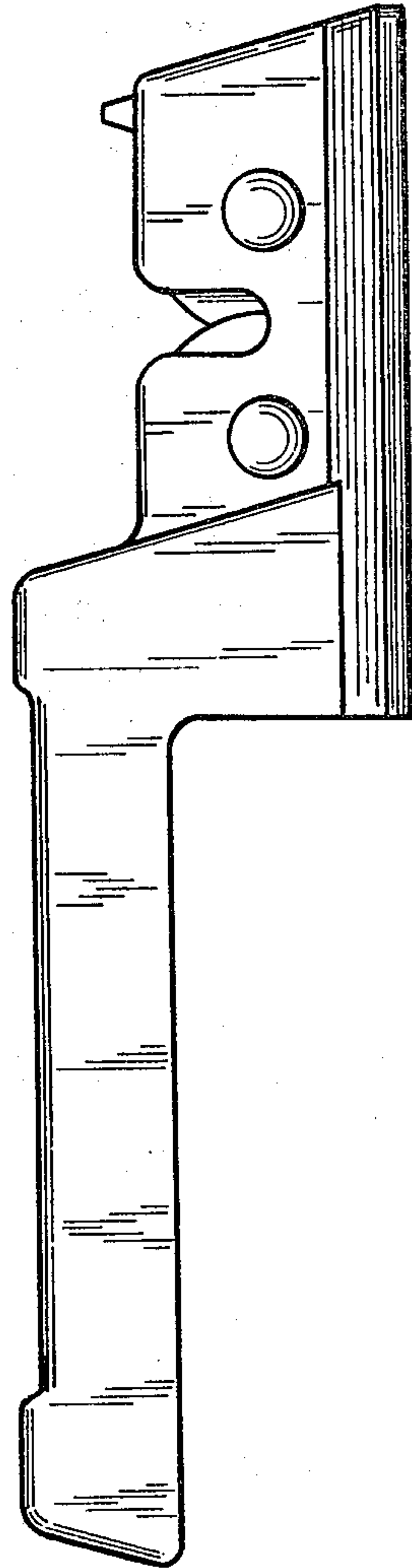

FIG. 5

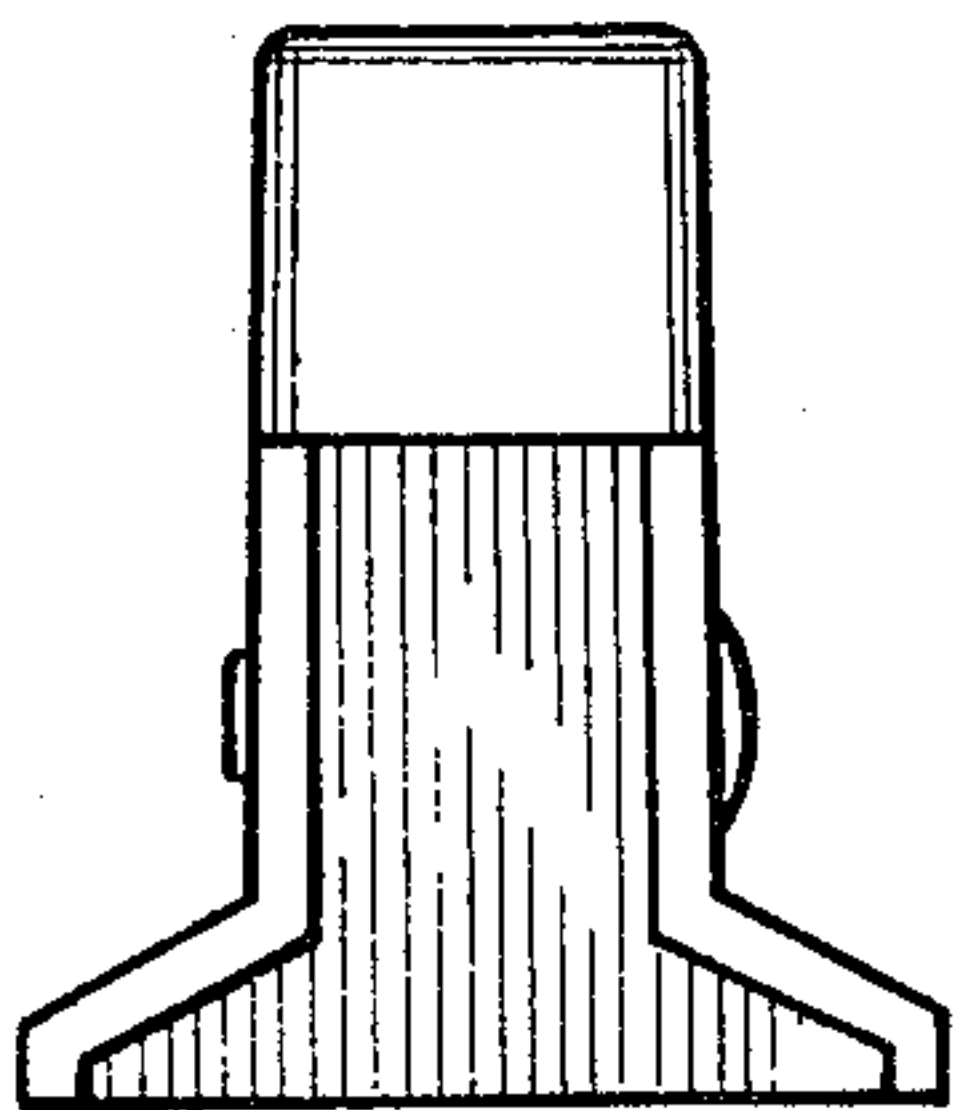

FIG. 6



FIG. 7

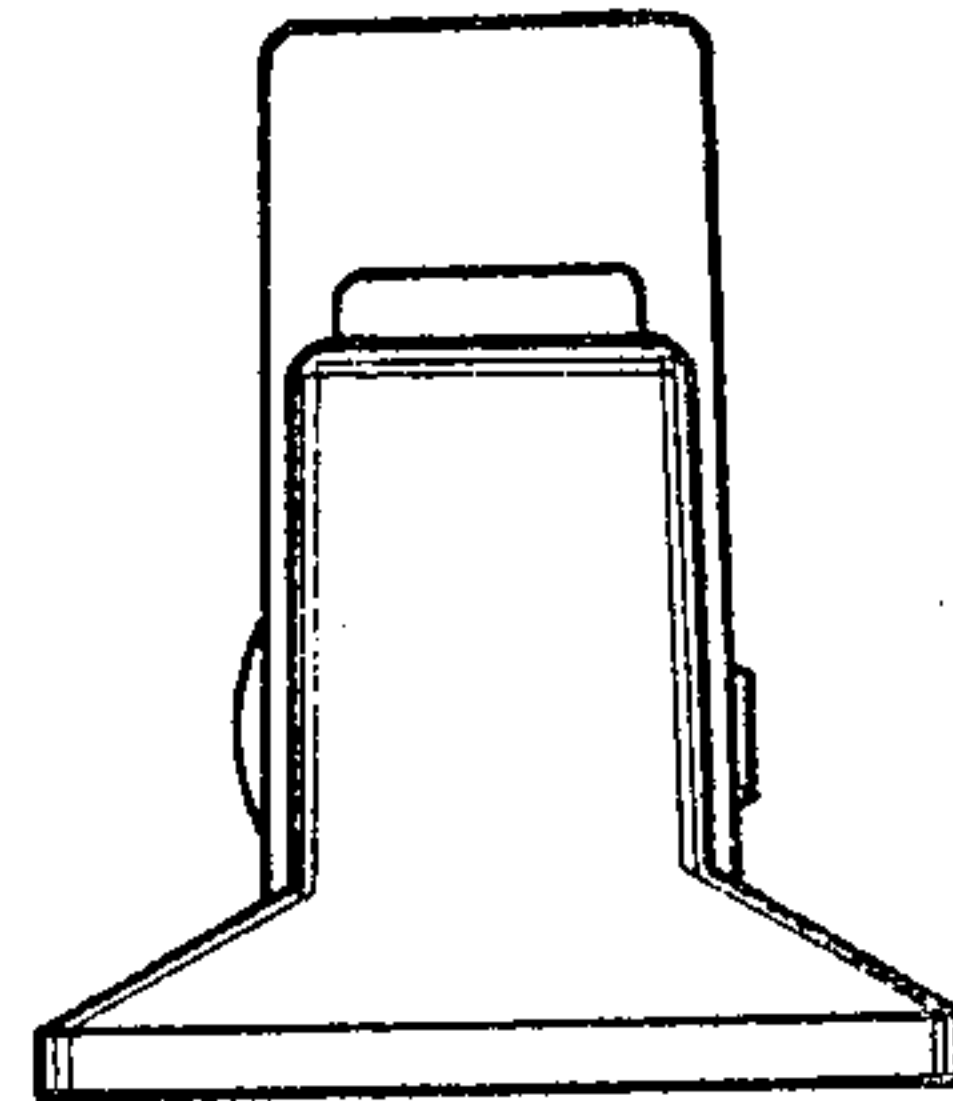

FIG.3

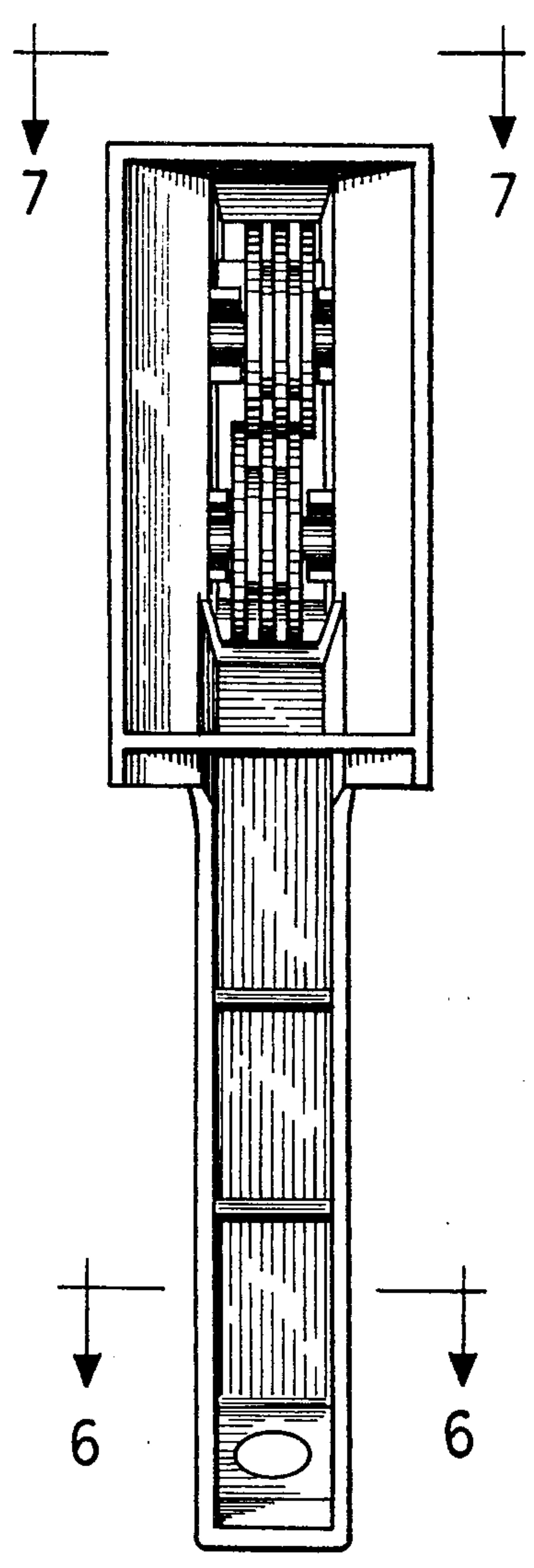

FIG.4

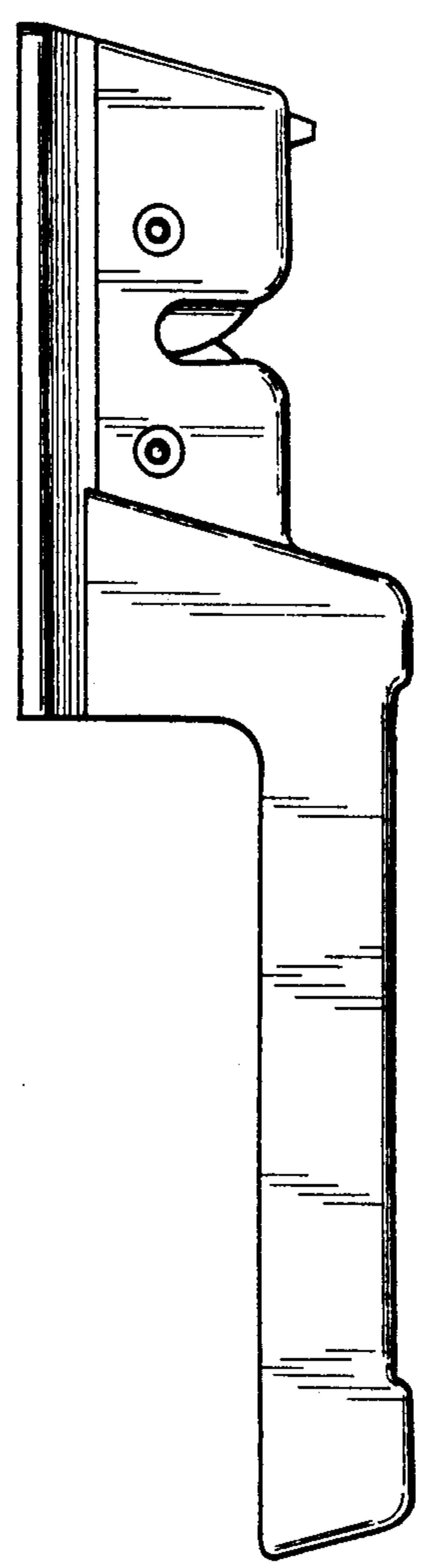

FIG.8

