

[54] CAVIAR-CUP
 [75] Inventor: Joseph Kanoui, Geneva, Switzerland
 [73] Assignee: Interdica S.A., Villars-sur-Glane, Switzerland
 [**] Term: 14 Years
 [21] Appl. No.: 325,921
 [22] Filed: Nov. 30, 1981

D. 176,634 1/1956 Schlumbohm D7/1 X
 D. 259,757 7/1981 Perrin D7/15
 776,363 11/1904 Snyder D7/27 X
 1,858,728 5/1932 Creighton D7/27 X

OTHER PUBLICATIONS

The Glass of Frederick Carder, by Paul Gardner ©1971, p. 304, item #6632—Aquariums middle—right col.
The Glass of Frederick Carder, by Paul Gardner ©1971, p. 304, Item #6683—Aquariums, r. col., 4th down.

Primary Examiner—Winifred E. Herrmann
 Attorney, Agent, or Firm—Cushman, Darby & Cushman

[30] Foreign Application Priority Data
 May 29, 1981 [XH] The Hague 71 465
 [52] U.S. Cl. D7/27; D7/3; D7/28
 [58] Field of Search D7/1, 3, 15, 28, 6, D7/23, 27, 70, 17, 79; D11/152, 153, 154

[57] CLAIM
 The ornamental design for a caviar-cup, as shown.

[56] References Cited
 U.S. PATENT DOCUMENTS
 D. 19,347 10/1889 Locke D7/28
 D. 72,900 6/1927 Kintz D7/28
 D. 89,396 3/1933 Goddard D7/17
 D. 120,513 5/1940 Prouty D7/28

DESCRIPTION

FIG. 1 is a front elevational view of a caviar-cup showing my new design;
 FIG. 2 is a bottom plan view thereof;
 FIG. 3 is a top plan view thereof;
 FIG. 4 is a left side elevational view thereof;
 FIG. 5 is a right side elevational view thereof; and
 FIG. 6 is a rear elevational view thereof.

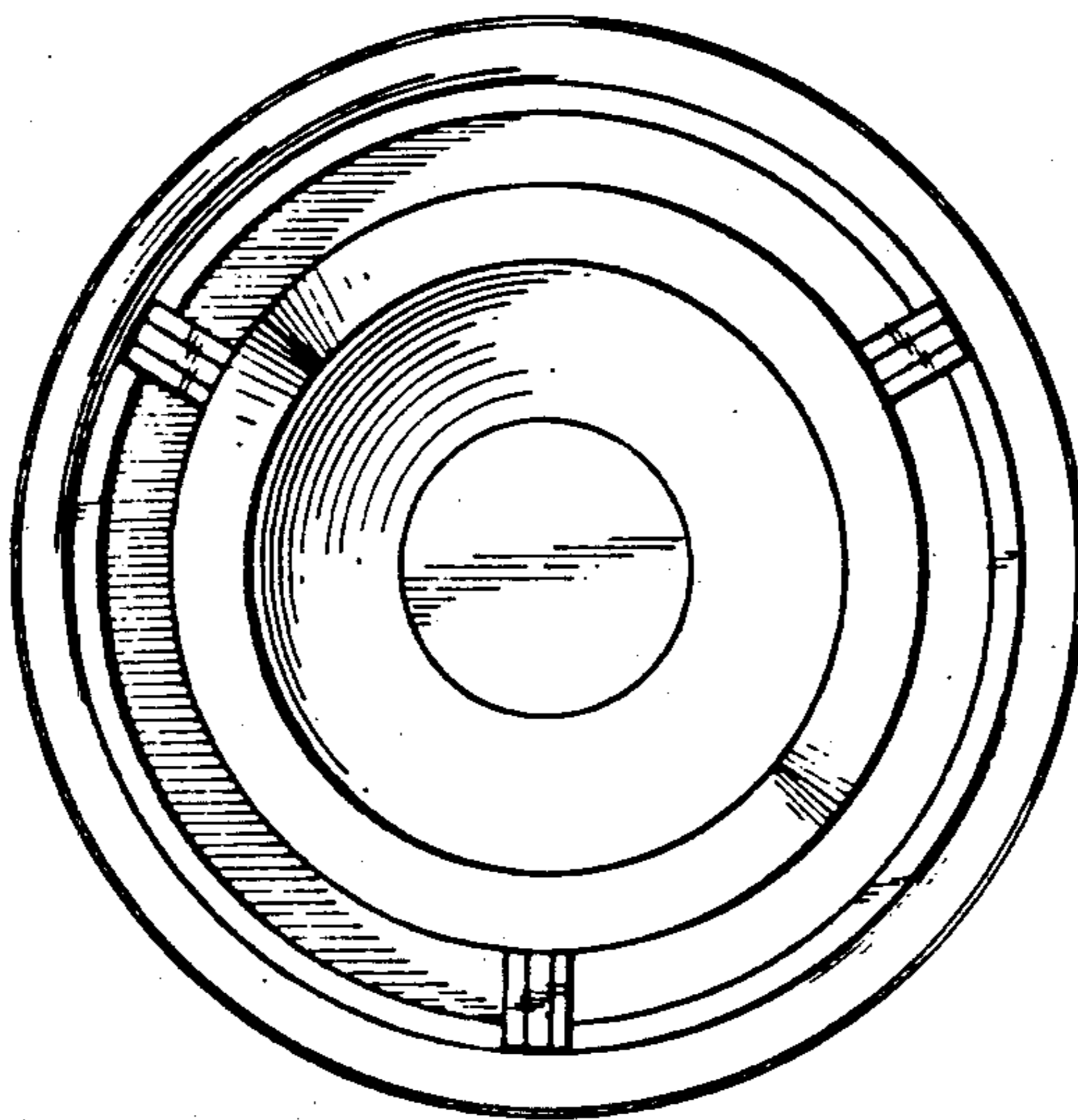
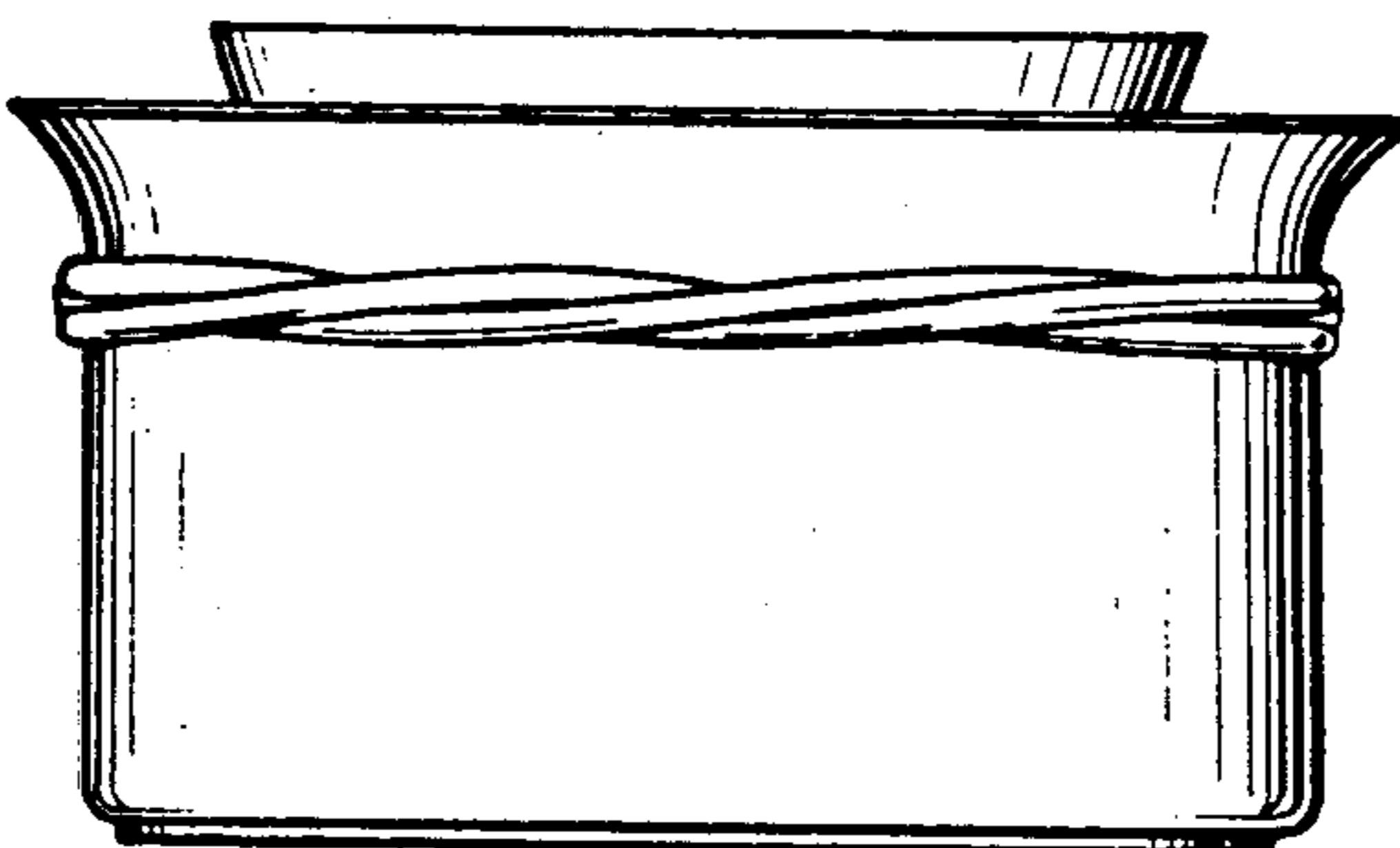

Fig. 2

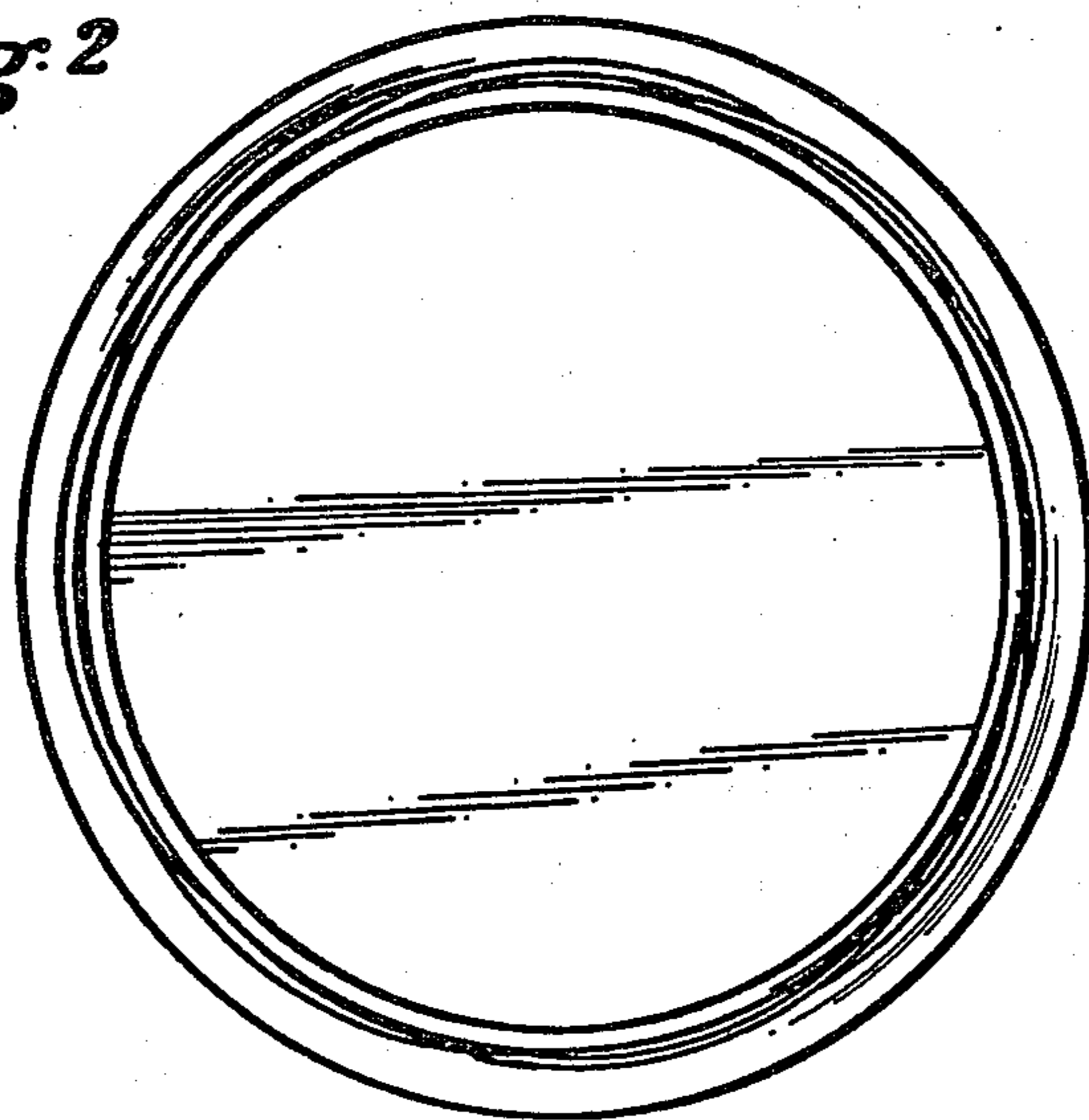

Fig. 1

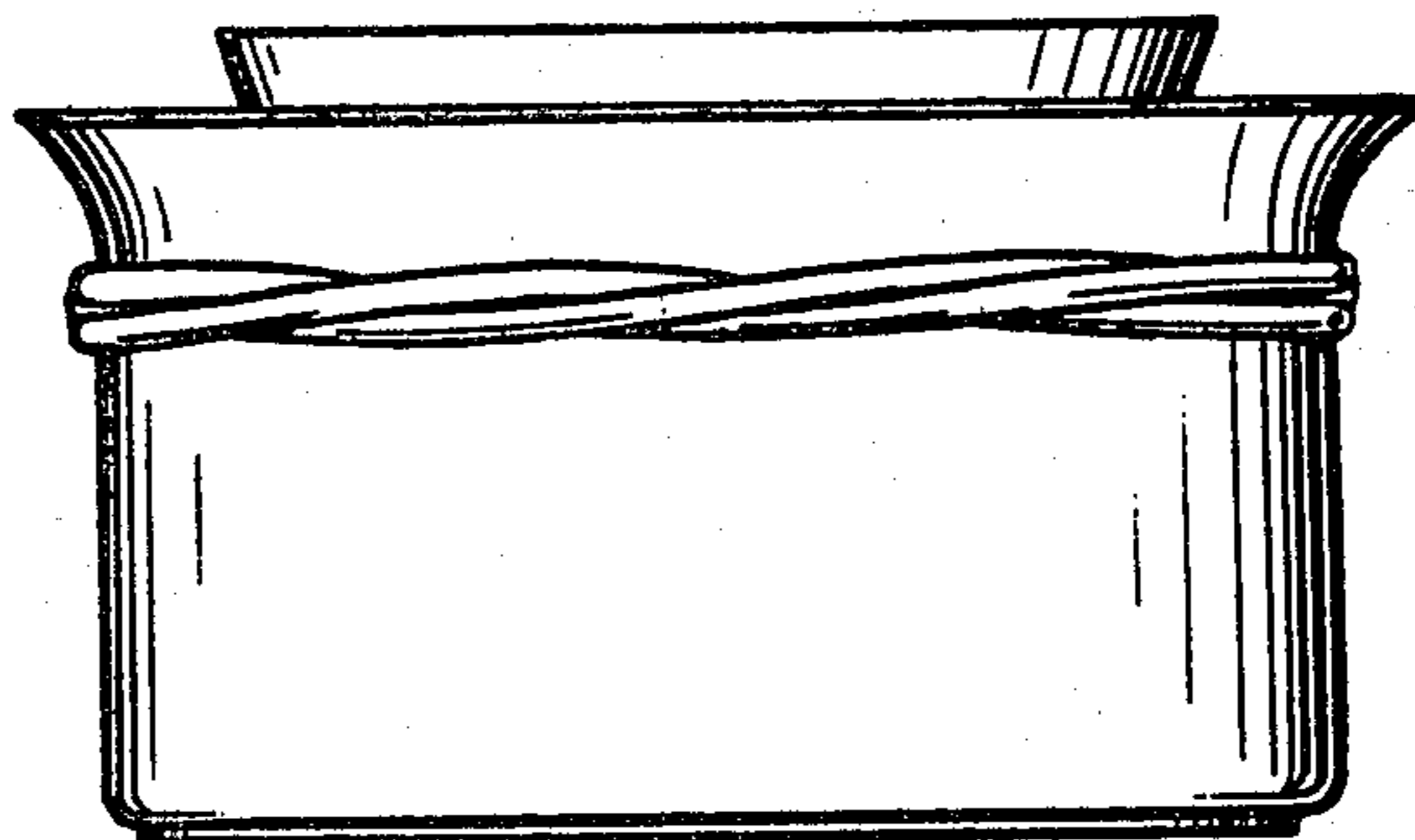

Fig. 3

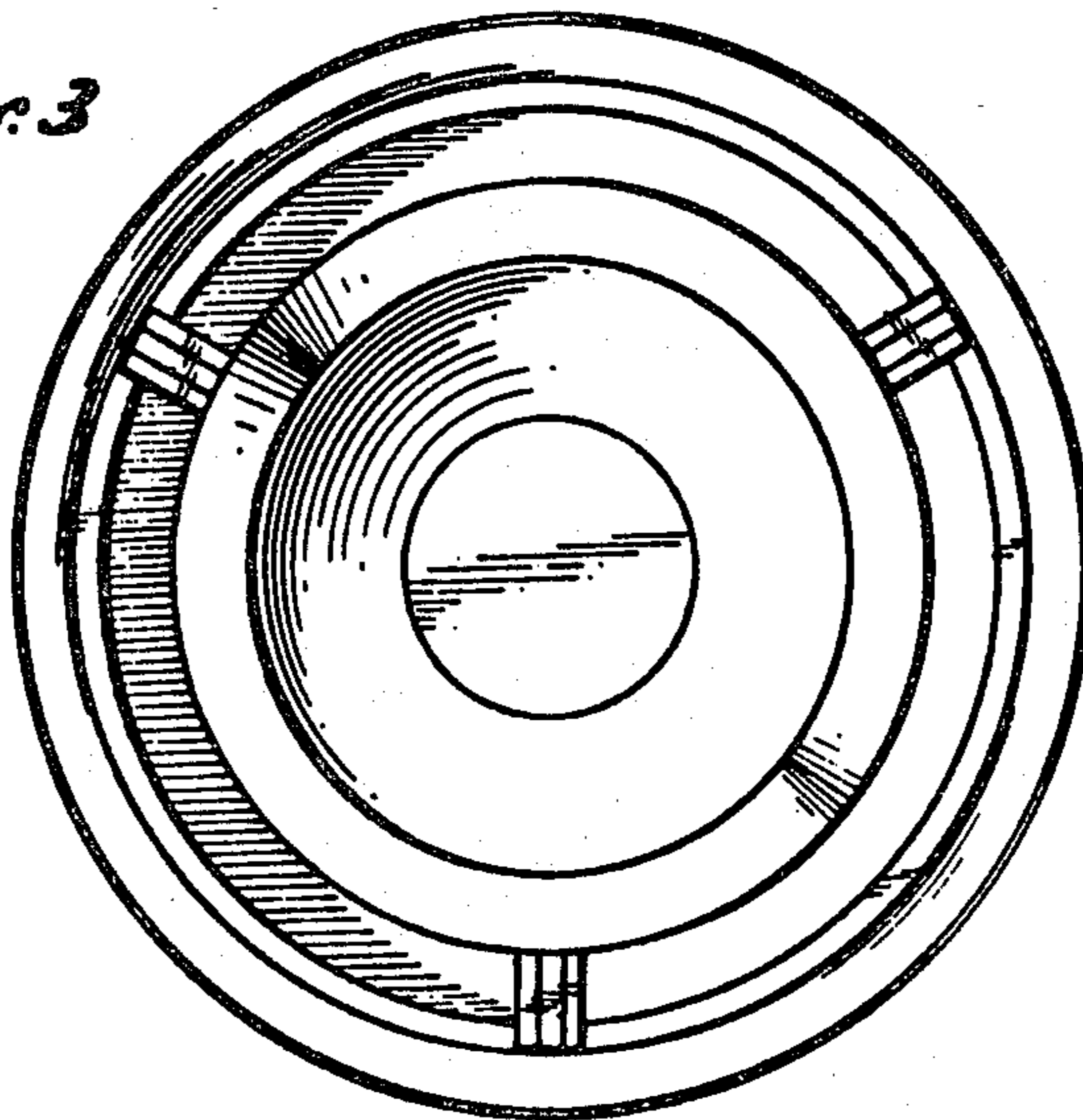

Fig. 4

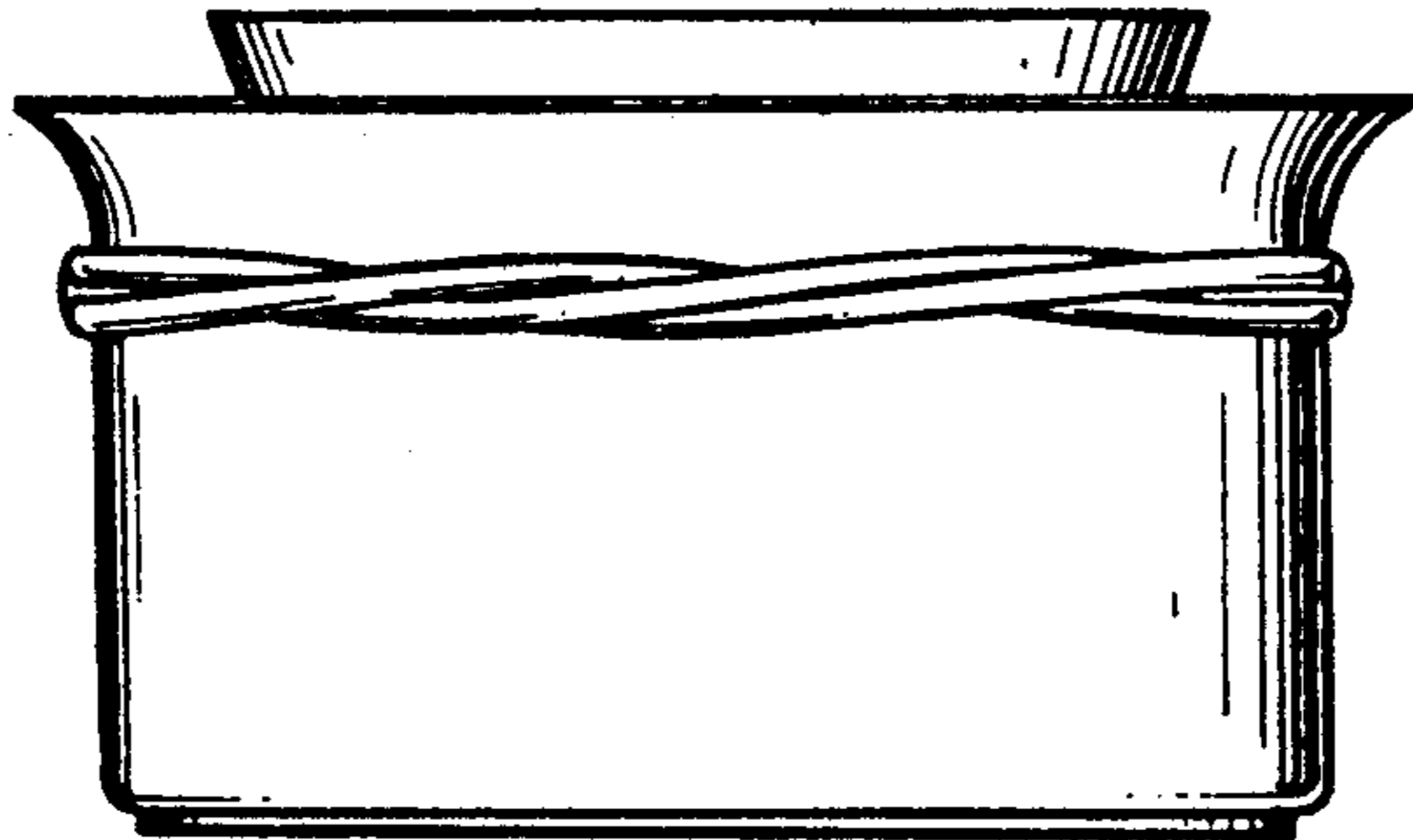

Fig. 5

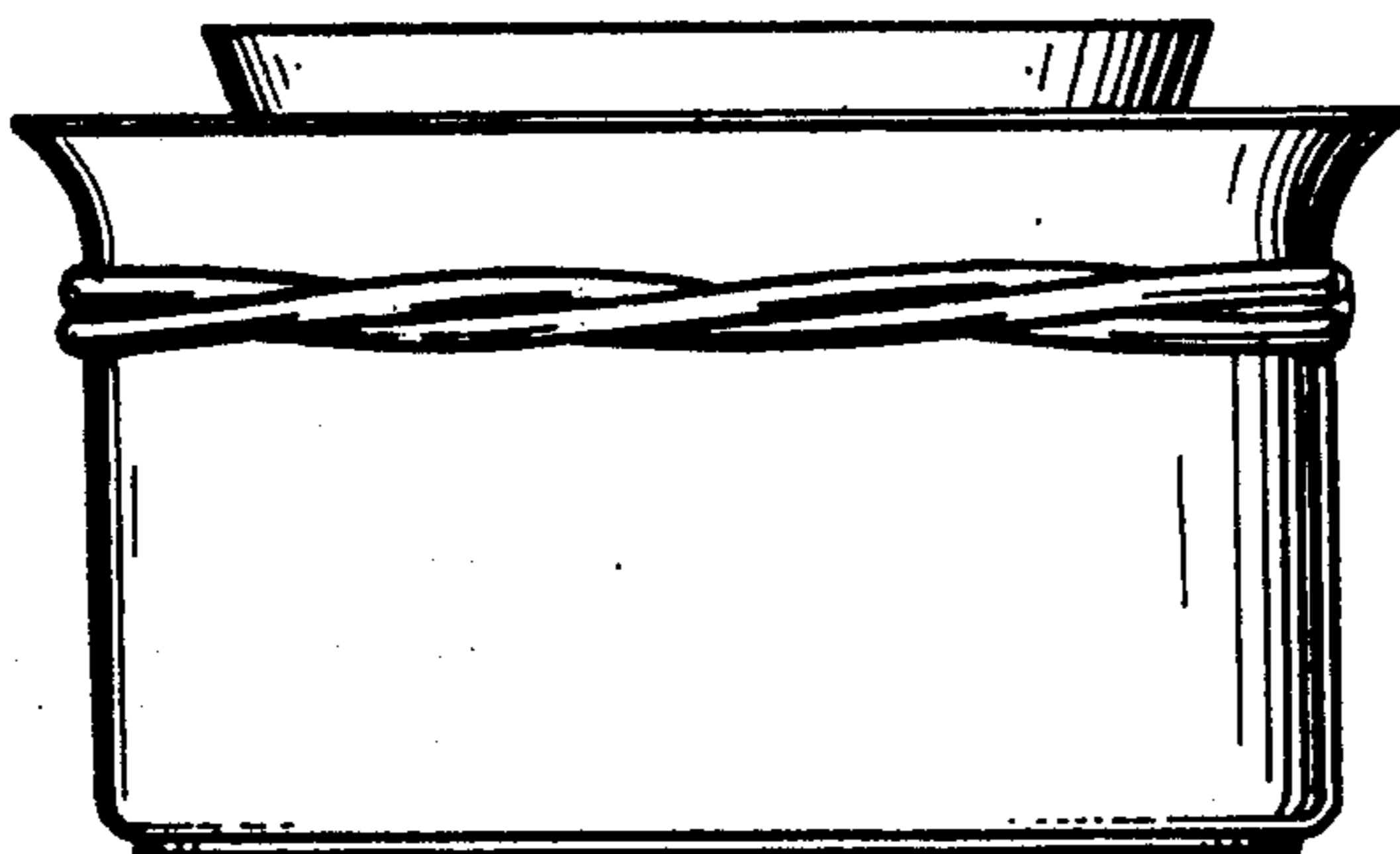

Fig. 6

