

[54] LIFT FOR RAISING AND LOWERING AN OBJECT

3,749,342 7/1973 Perrine 248/123
4,166,602 9/1979 Nilsen et al. 248/280.1
4,403,760 9/1983 Alvermann 248/284

[76] Inventor: Palmer C. Alvermann, Rte. 1, Box 138, Clear Lake, Wis. 54005

Primary Examiner—James M. Gandy
Attorney, Agent, or Firm—Burd, Bartz & Gutenkauf

[**] Term: 14 Years

[57] CLAIM

[21] Appl. No.: 340,348

The ornamental design for a lift for raising and lowering an object, as shown and described.

[22] Filed: Jan. 18, 1982

[52] U.S. Cl. D34/33; D99/32

DESCRIPTION

[58] Field of Search D34/33; D99/32;
248/284, 280.1, 281.1

FIG. 1 is a perspective view of a lift for raising and lowering an object of my new design;

[56] References Cited

U.S. PATENT DOCUMENTS

2,898,066 8/1959 Ouellette 248/145
2,997,242 8/1961 Grosholz 239/278
3,391,890 7/1968 Perbal 248/280
3,436,046 4/1969 Valeska 248/284

FIG. 2 is an enlarged side elevational view of the right side of FIG. 1;

FIG. 3 is an enlarged elevational view of the left side of FIG. 1;

FIG. 4 is an enlarged rear elevational view of FIG. 1;

FIG. 5 is an enlarged top view of FIG. 1; and

FIG. 6 is an enlarged bottom view of FIG. 1.

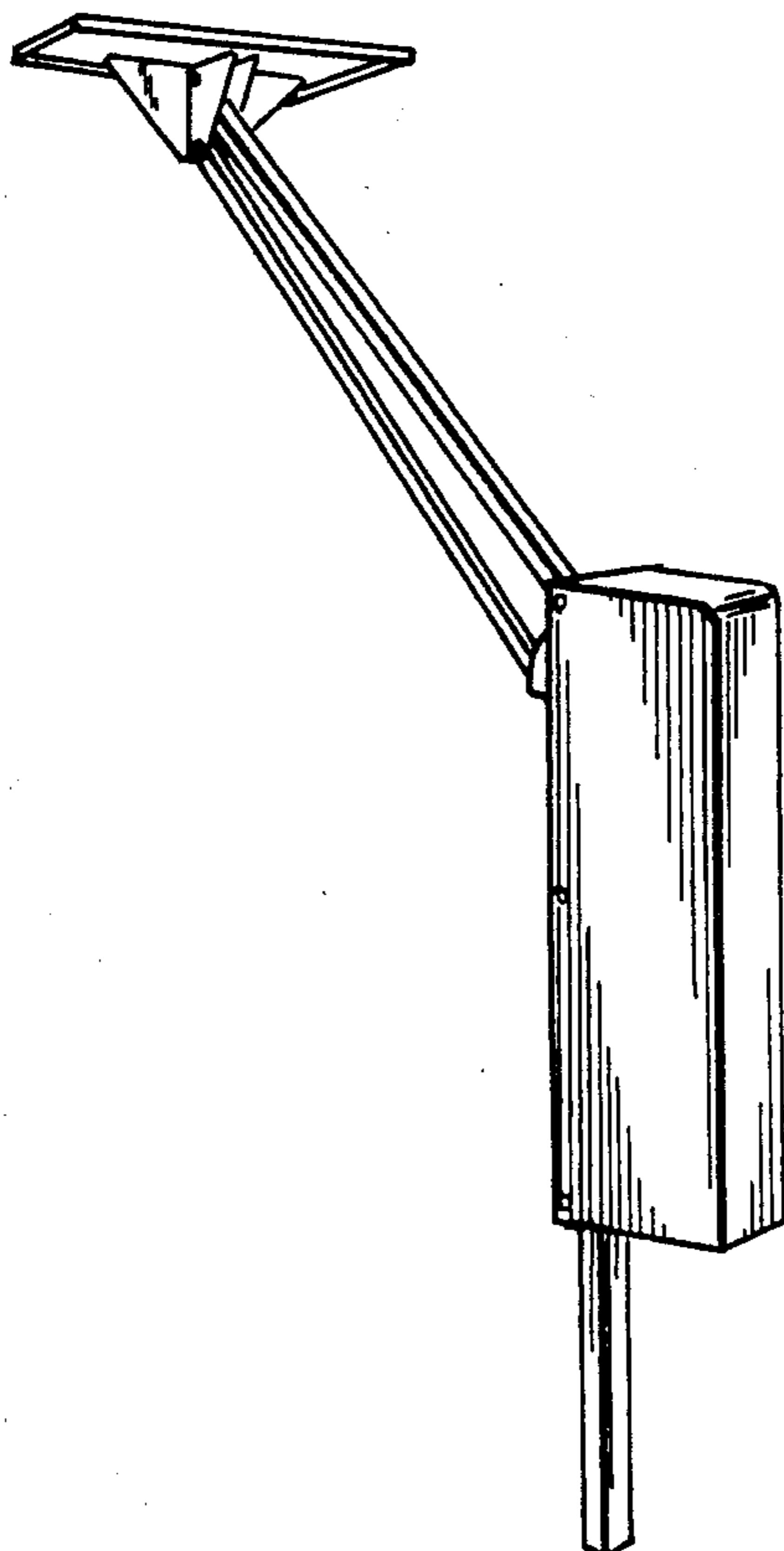

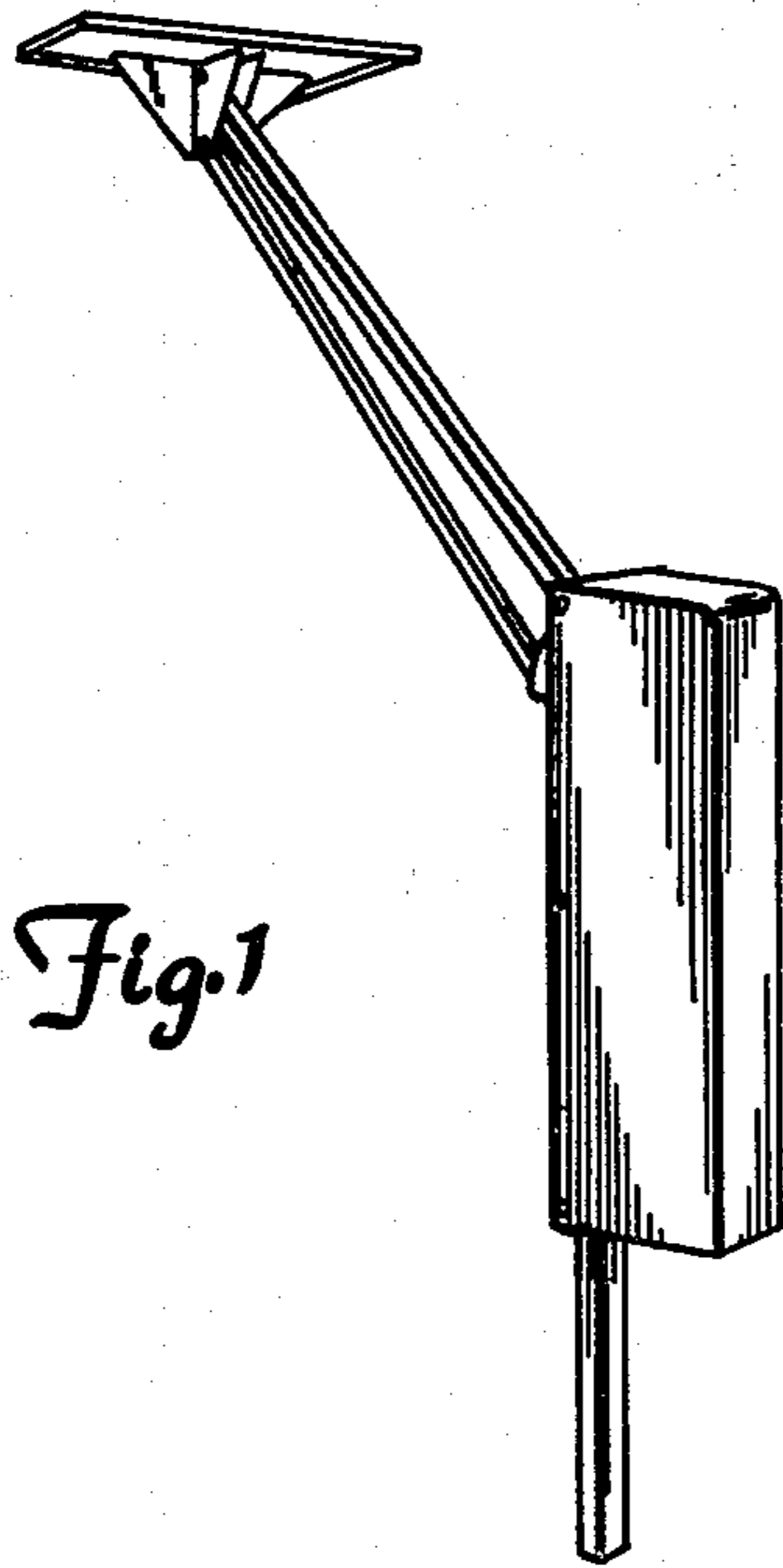

Fig. 1

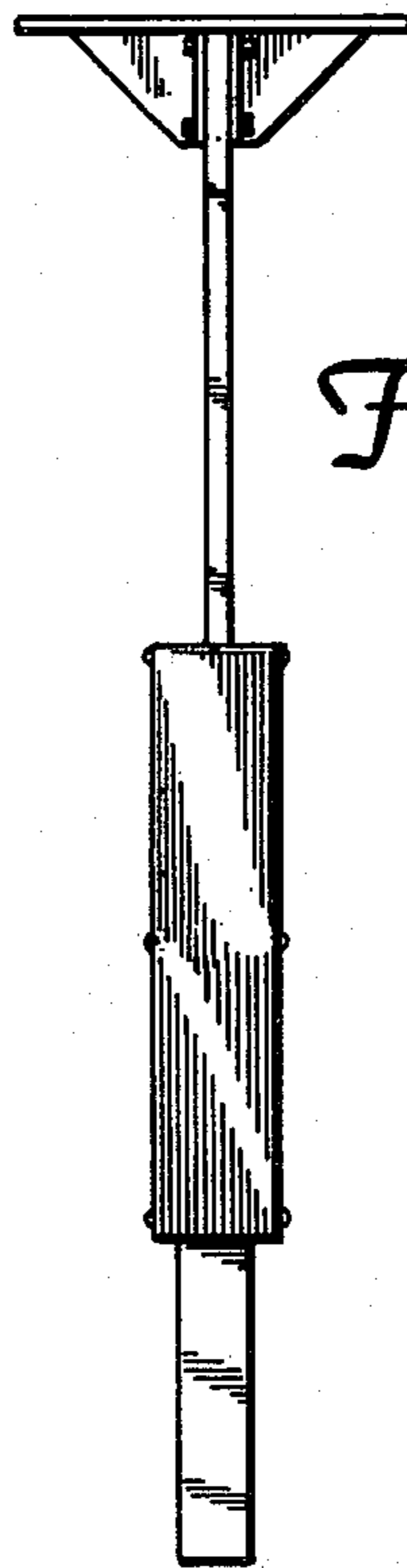

Fig 2

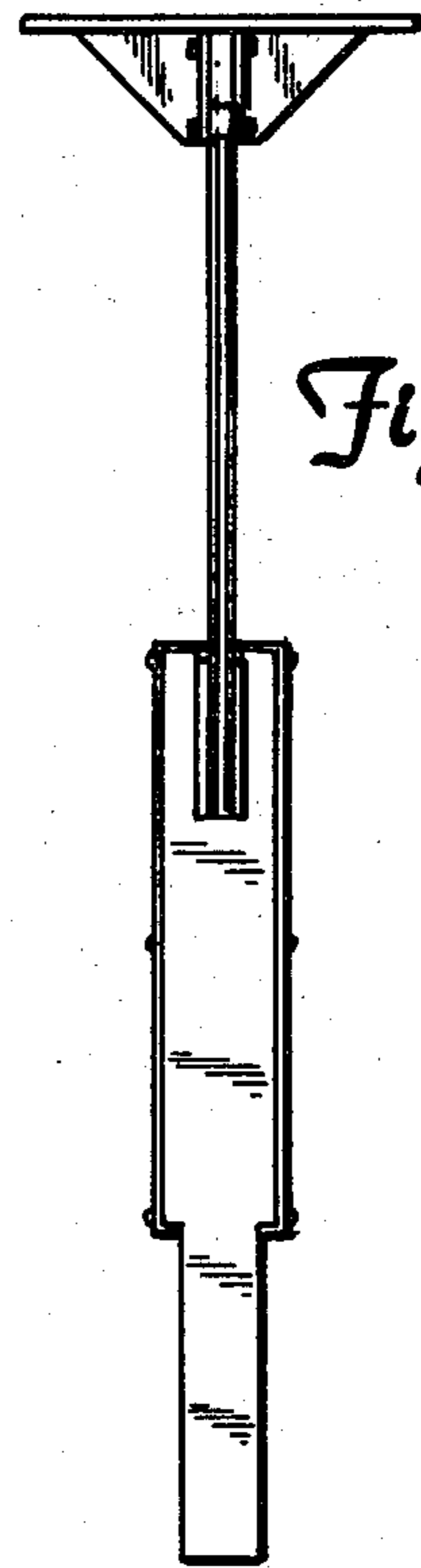

Fig.3

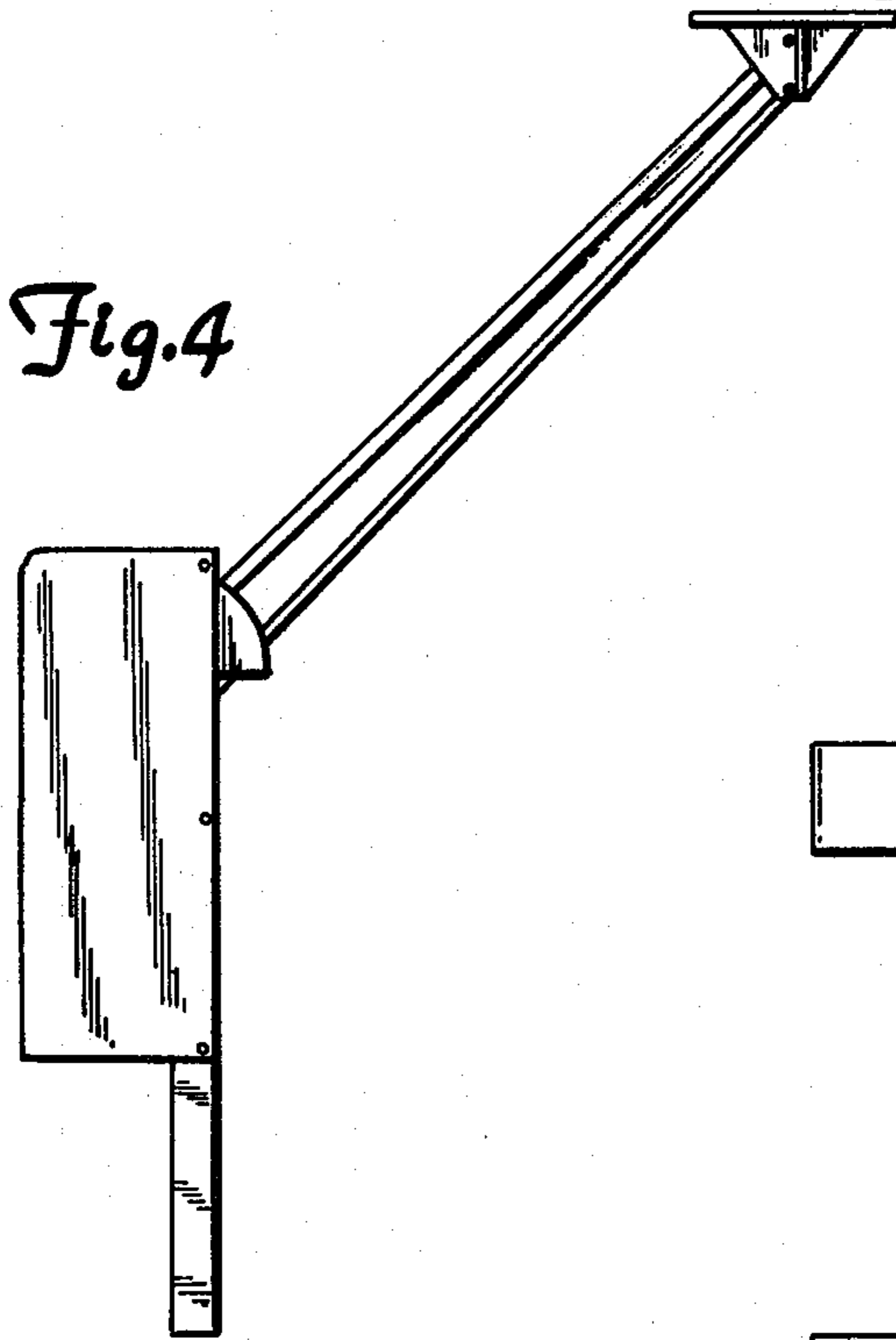

Fig.4

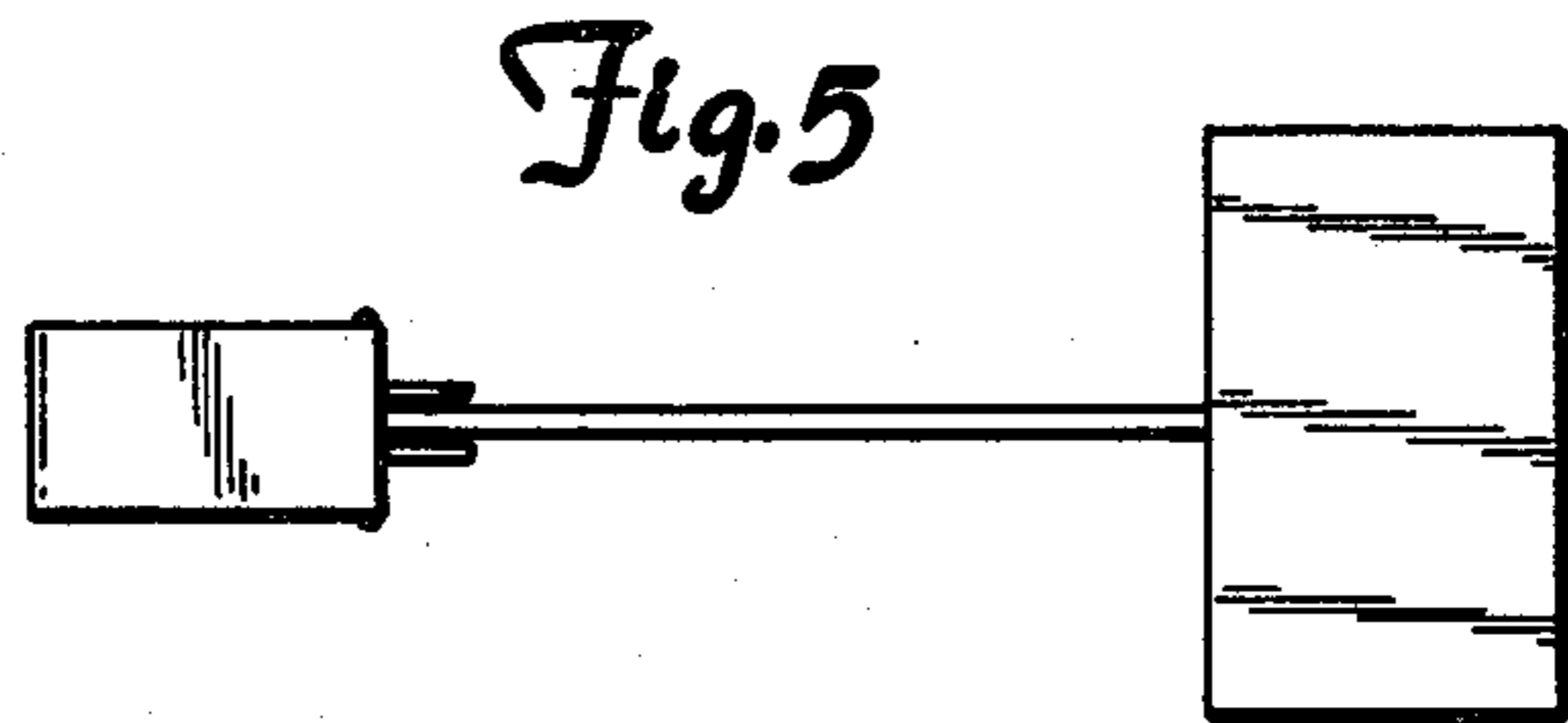

Fig.5

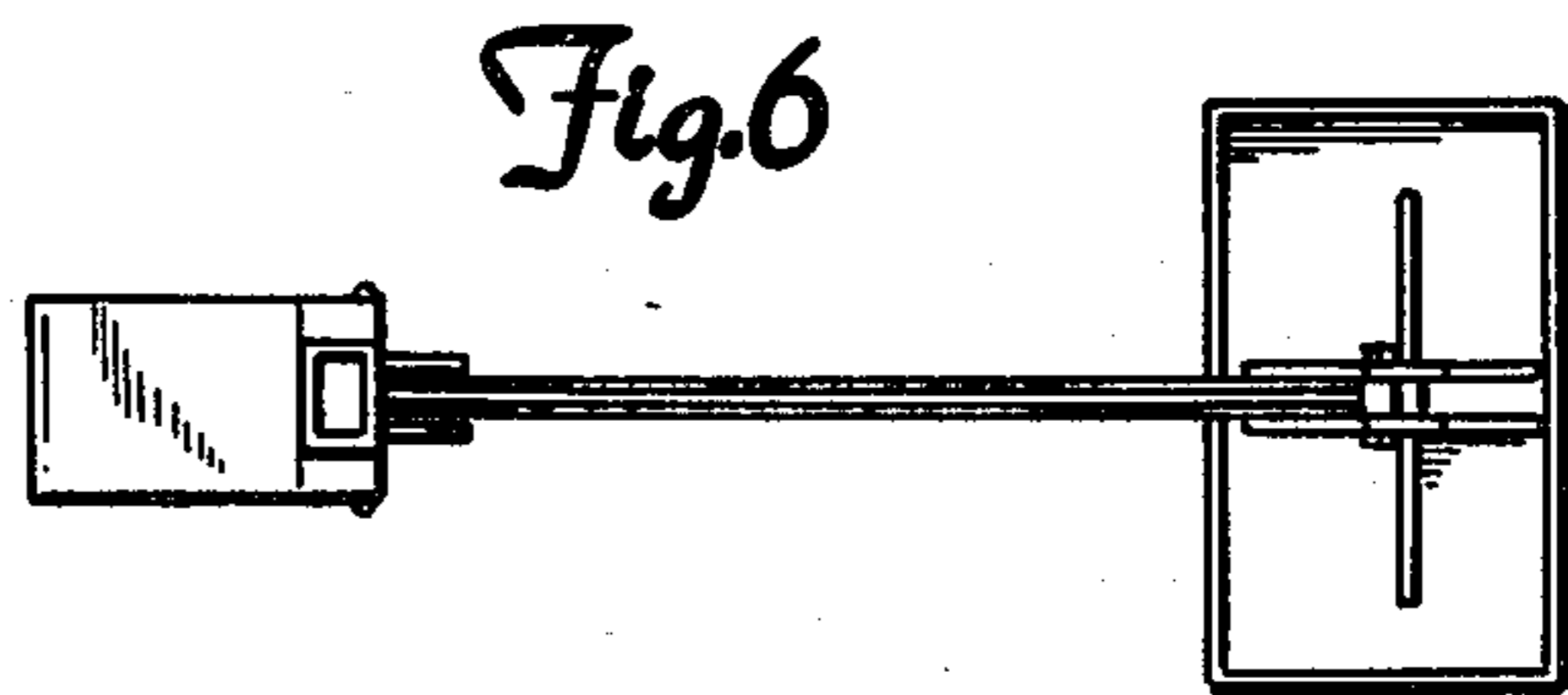

Fig.6