

[54] JUG

[75] Inventor: Robert C. Collins, II, Kentwood, Mich.

[73] Assignee: Amway Corporation, Ada, Mich.

[**] Term: 14 Years

[21] Appl. No.: 309,997

[22] Filed: Oct. 9, 1981

[52] U.S. Cl. D9/376

[58] Field of Search D9/370, 374, 376, 378-383; 215/1 R, 1 C

[56] References Cited

U.S. PATENT DOCUMENTS

D. 228,230	8/1973	Cutler	D9/376
D. 229,483	12/1973	Cutler	D9/376
D. 237,255	10/1975	Plummer	D9/376
D. 256,665	9/1980	Smythe	D9/374

Primary Examiner—Robert C. Spangler
Attorney, Agent, or Firm—Price, Heneveld, Huizenga & Cooper

[57] CLAIM

The ornamental design for the jug, as shown and described.

DESCRIPTION

FIG. 1 is a perspective view of a jug showing my new design;
 FIG. 2 is an elevational view showing the side opposite that shown in FIG. 1;
 FIG. 3 is a top plan view;
 FIG. 4 is a bottom plan view;
 FIG. 5 is an elevational view looking from the left of FIG. 2;
 FIG. 6 is an elevational view looking from the right of FIG. 2; and
 FIG. 7 is a fragmentary sectional view taken along plane VII—VII in FIG. 4.

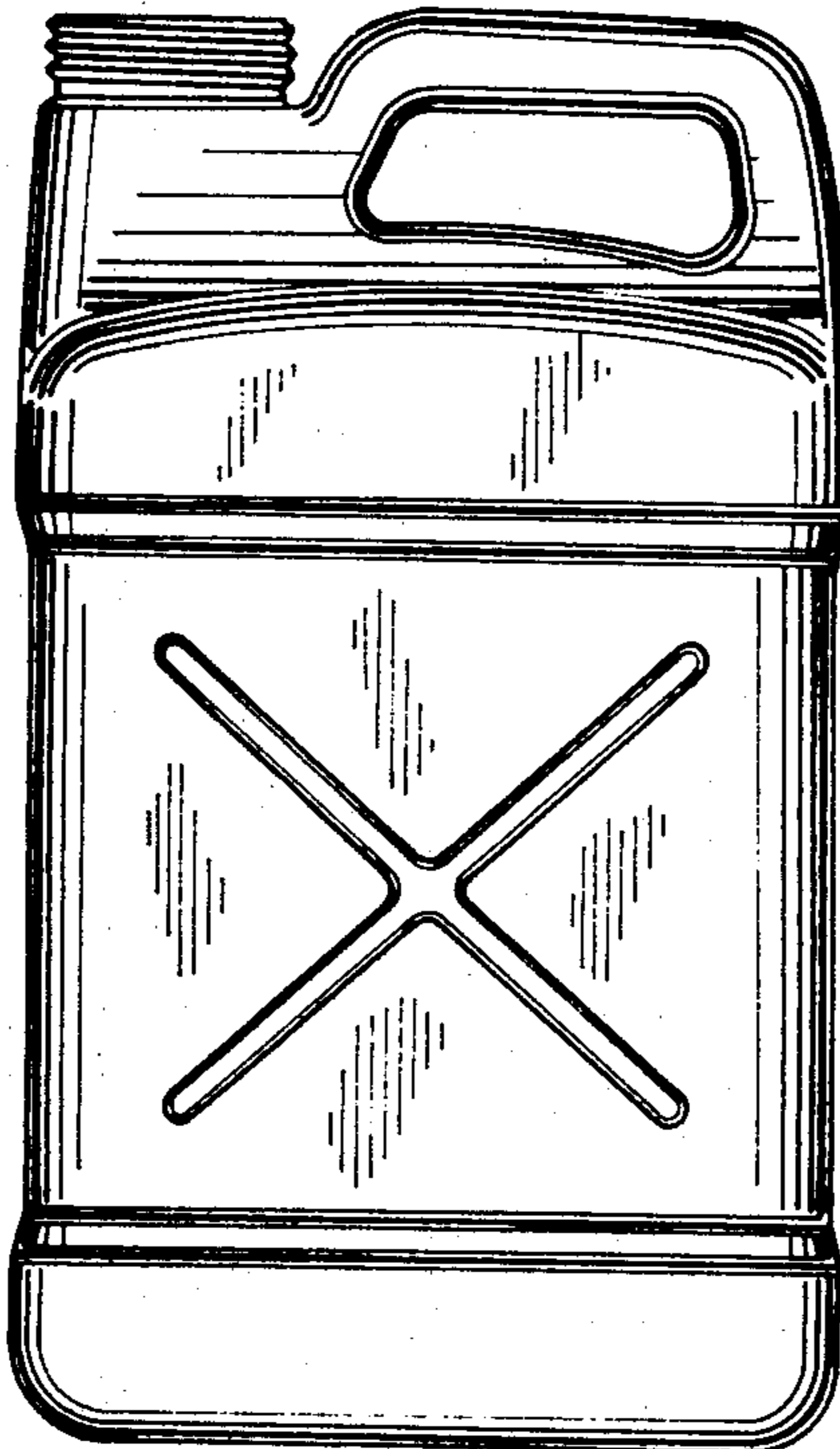

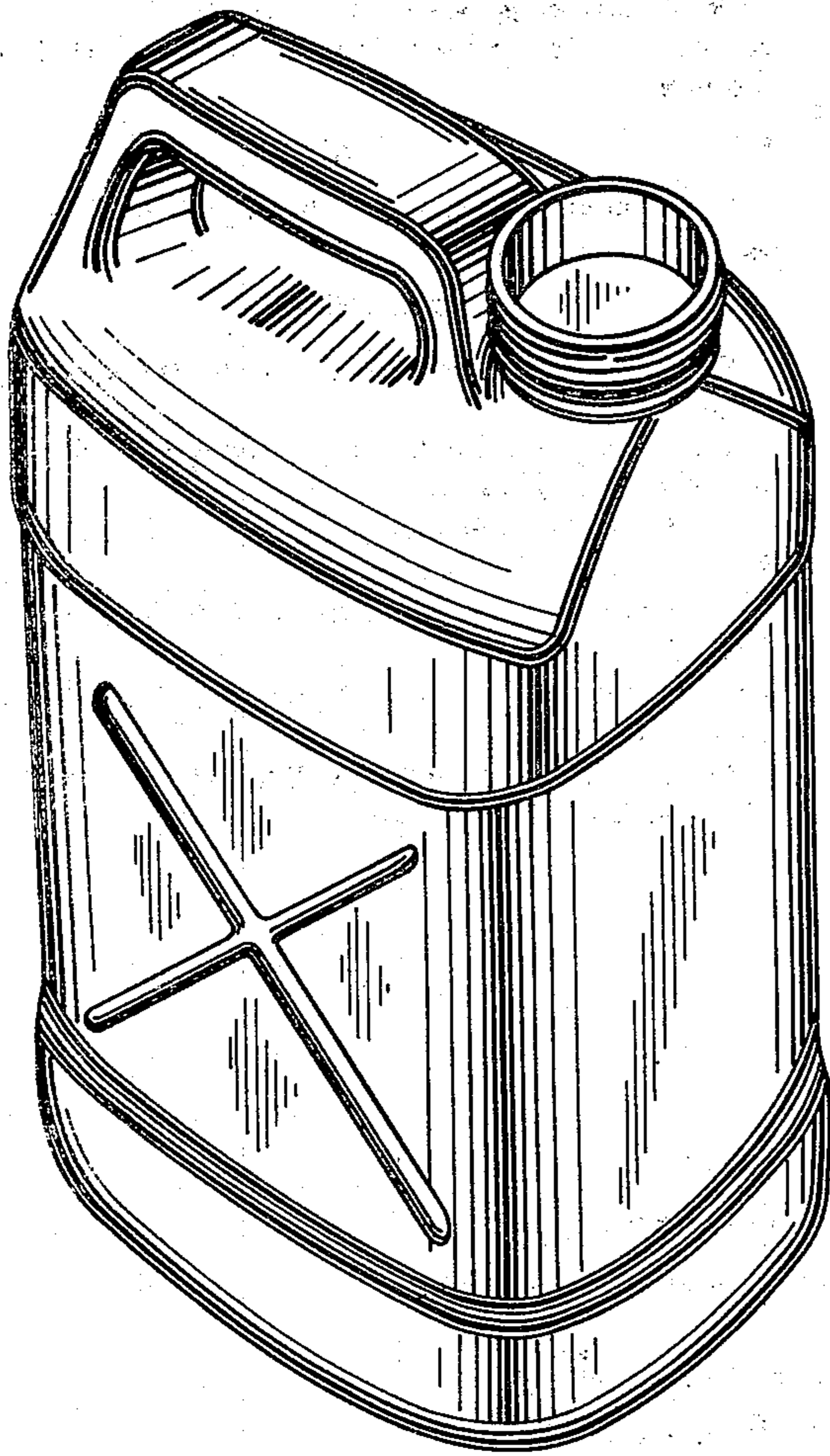

Fig. 1.

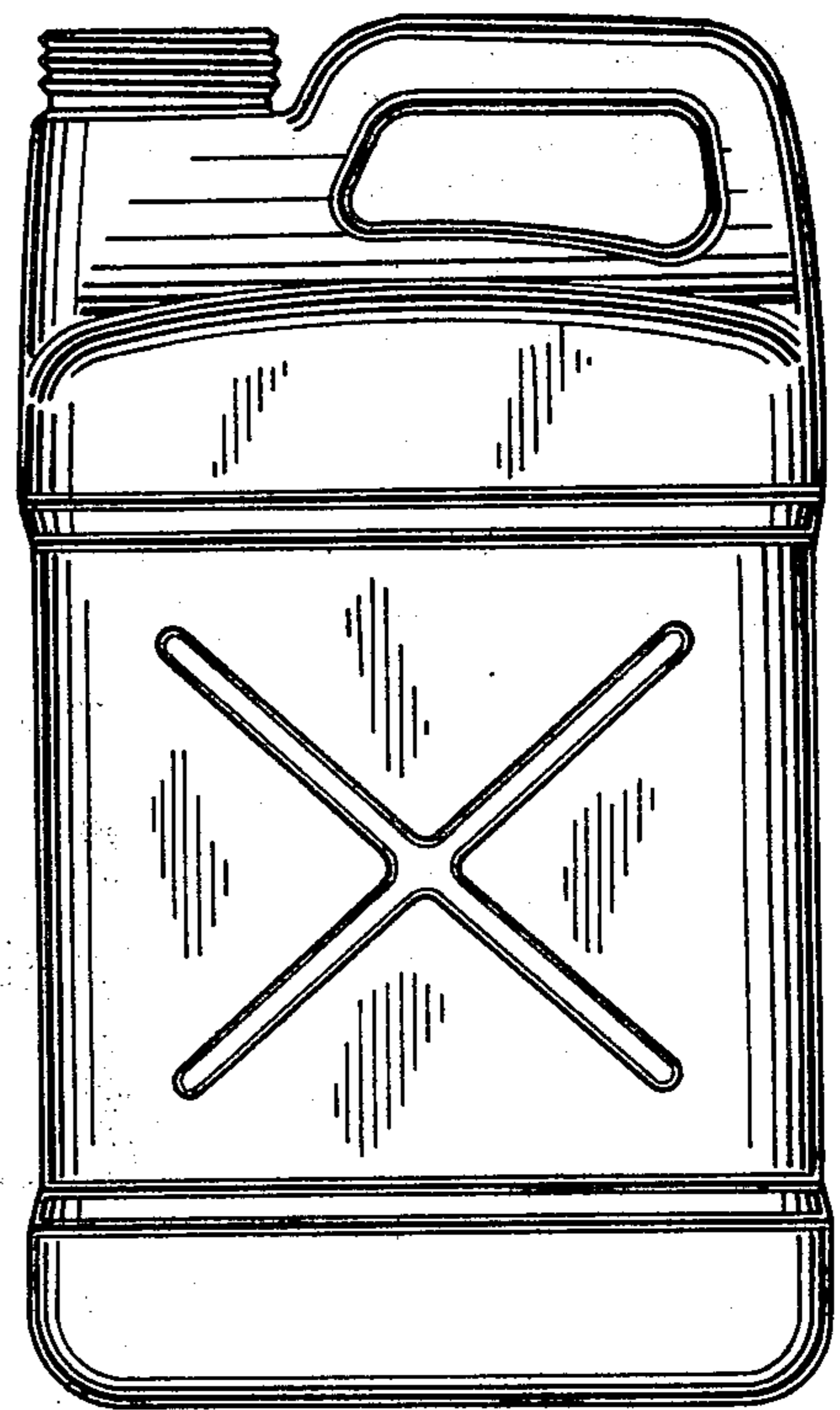

Fig. 2.

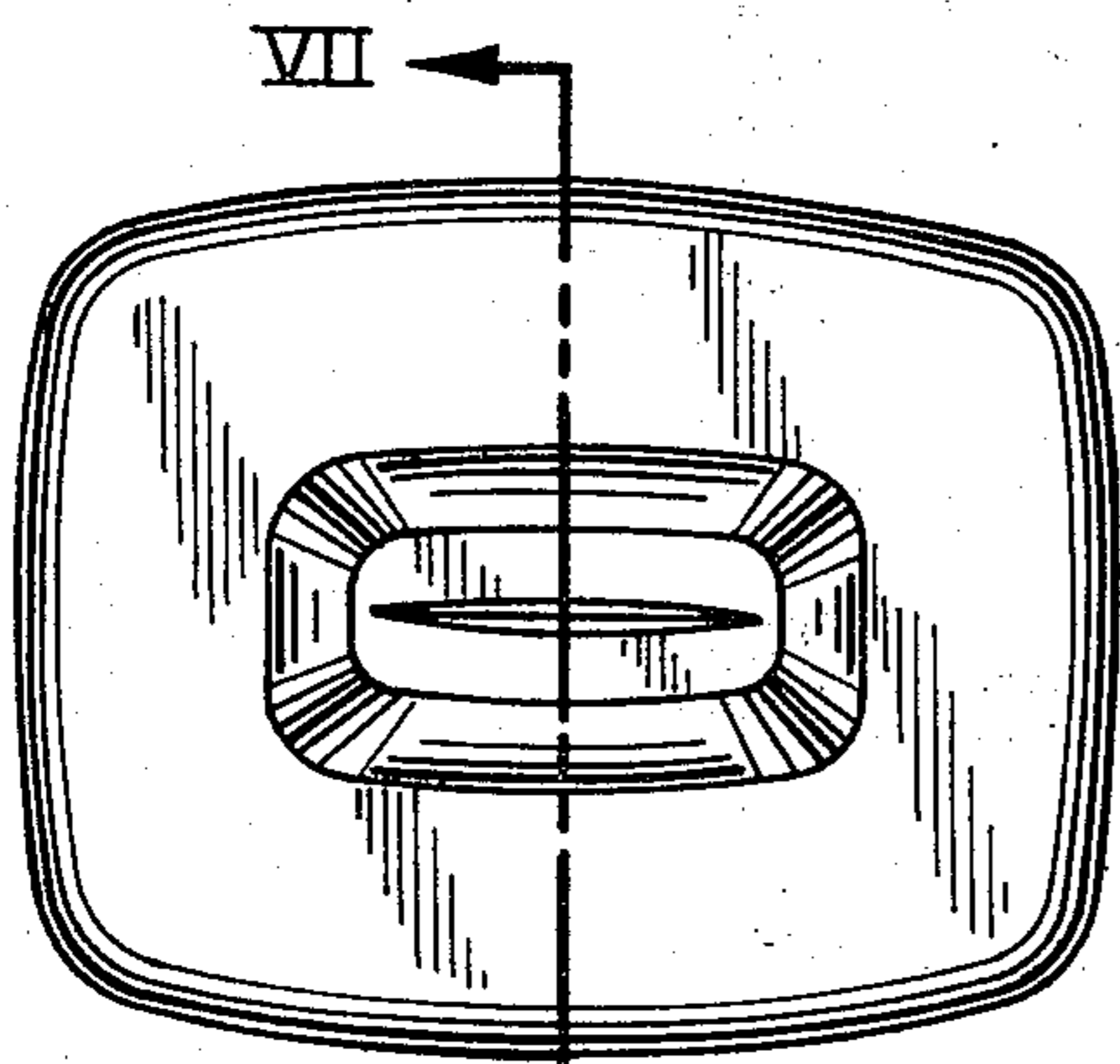

Fig. 4.



Fig. 7

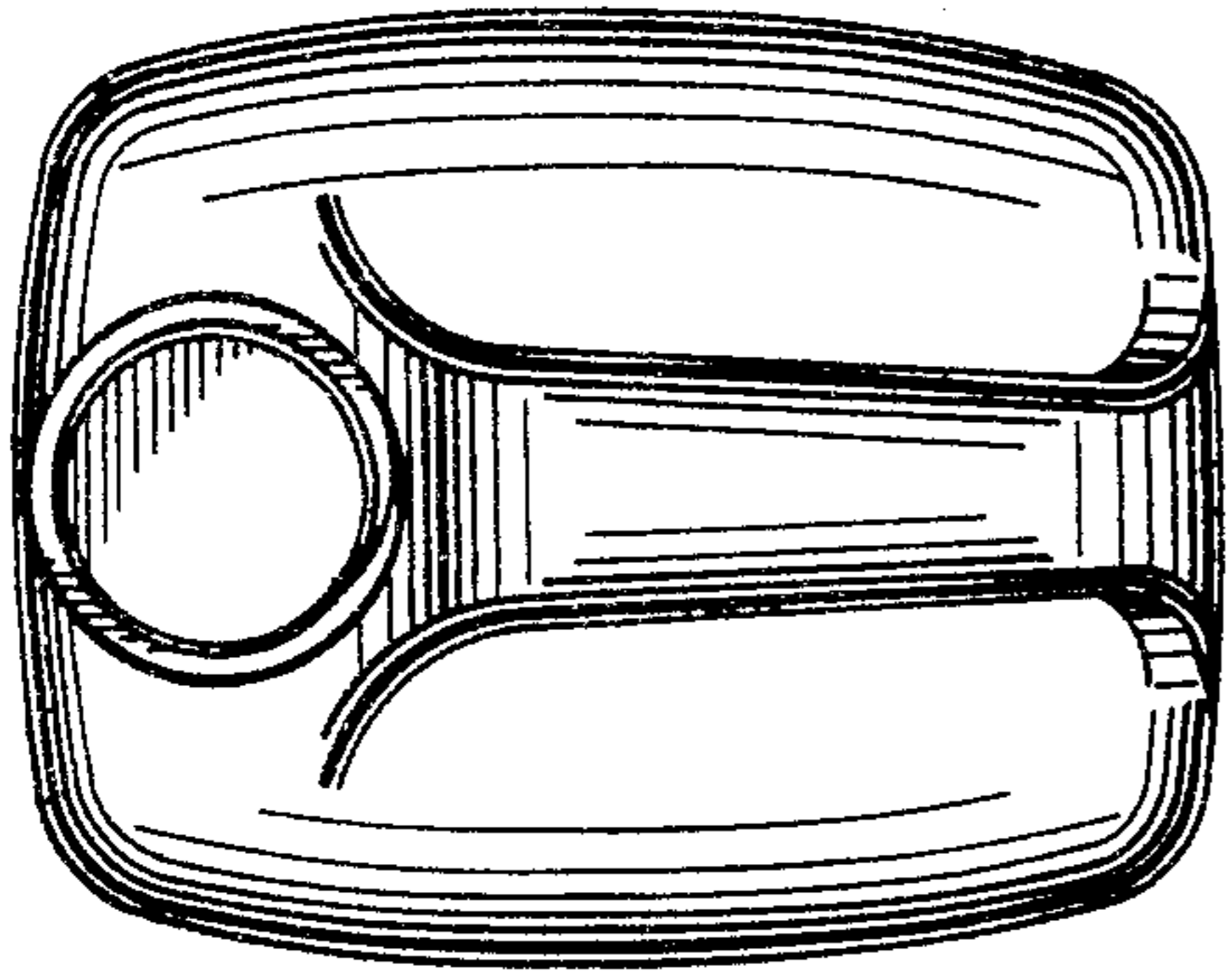

Fig. 3.

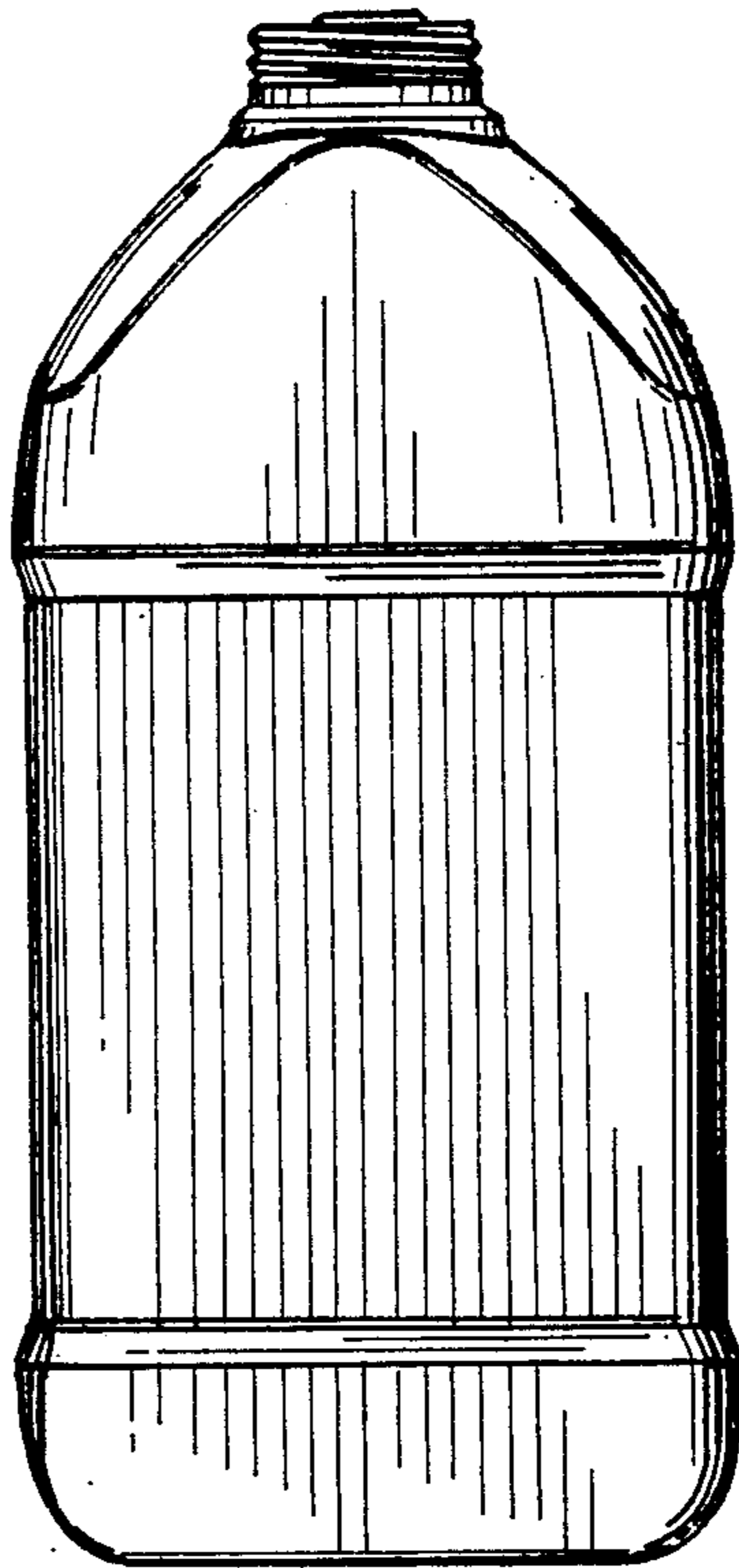

Fig. 5.

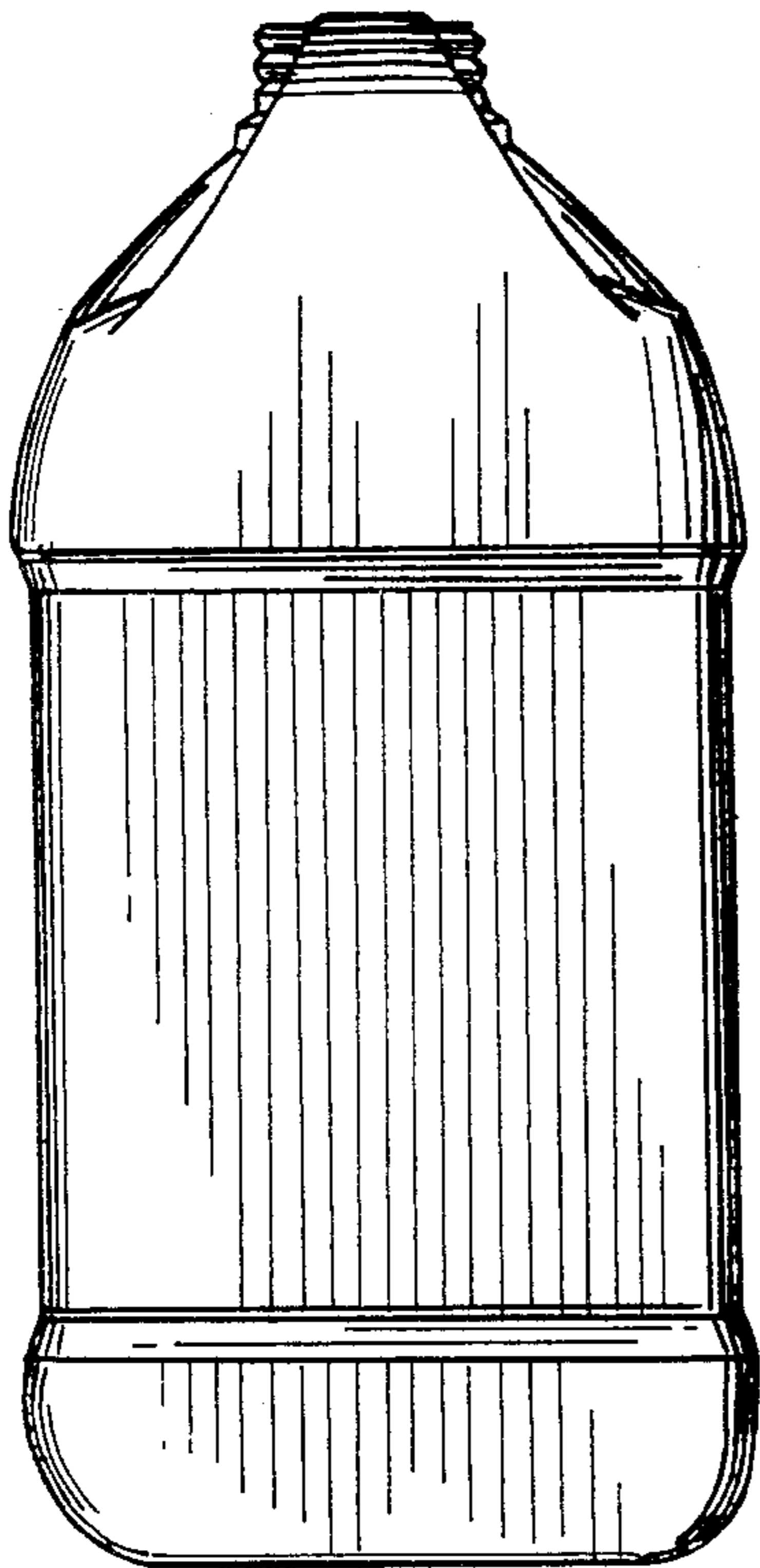

Fig. 6.