

[54] SEPARABLE HANDBAG

[76] Inventor: Sylvia Silk, 1641 3rd Ave., New York, N.Y. 10028

[**] Term: 14 Years

[21] Appl. No.: 249,217

[22] Filed: Mar. 30, 1981

[52] U.S. Cl. D3/52; D3/53; D3/79

[58] Field of Search D3/30.1, 42, 43, 52, D3/53, 79; 150/28 R, 52 J, 31, 28 A; 190/52, 60

[56] References Cited

U.S. PATENT DOCUMENTS

D. 171,995	4/1954	Aberman	D3/52
D. 266,201	9/1982	Berman	D3/79
1,841,154	1/1932	Rath	150/28 R
2,723,696	11/1955	Ikase	150/28 A
3,473,590	10/1969	Rohlk	150/28 R
3,537,628	11/1970	Thompson	190/52

FOREIGN PATENT DOCUMENTS

307098 4/1933 Italy 150/31

Primary Examiner—George P. Word

[57] CLAIM

The ornamental design for a dual and separable handbag, substantially as shown and described.

DESCRIPTION

FIG. 1 is a front elevational view of a separable handbag showing my new design;
FIG. 2 is a rear elevational view of FIG. 1;
FIG. 3 is a bottom plan view of FIG. 1;
FIG. 4 is a front elevational view of one of body portions, showing the smaller cover attached and in closed condition;
FIG. 5 is a rear elevational view of FIG. 4;
FIG. 6 is an enlarged scale left side elevational view of FIG. 4;
FIG. 7 is an enlarged scale left side elevational view of FIG. 1;
FIG. 8 is an exploded perspective view thereof, and
FIG. 9 is an enlarged scale top plan view of FIG. 1 in the open condition.

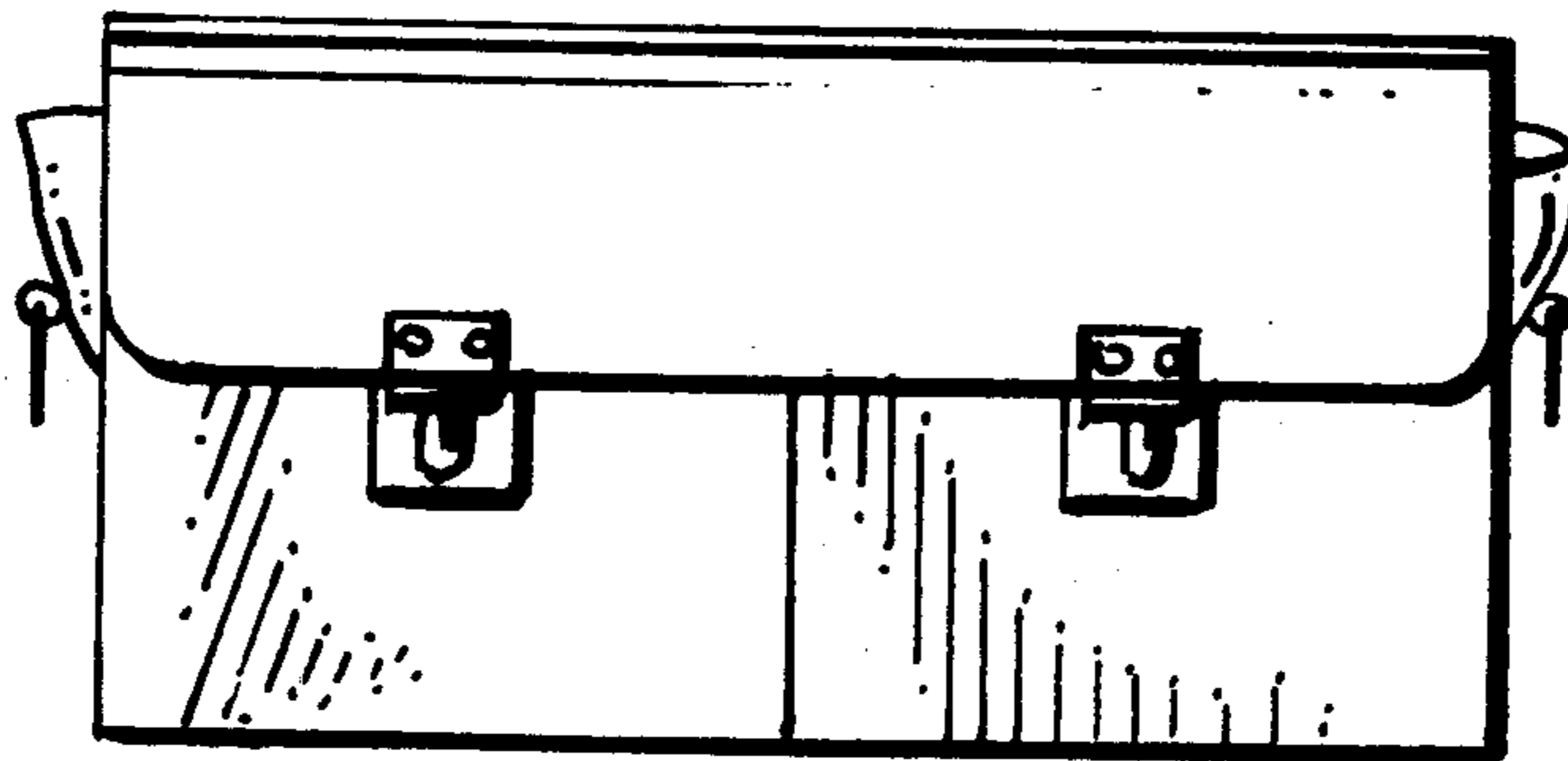

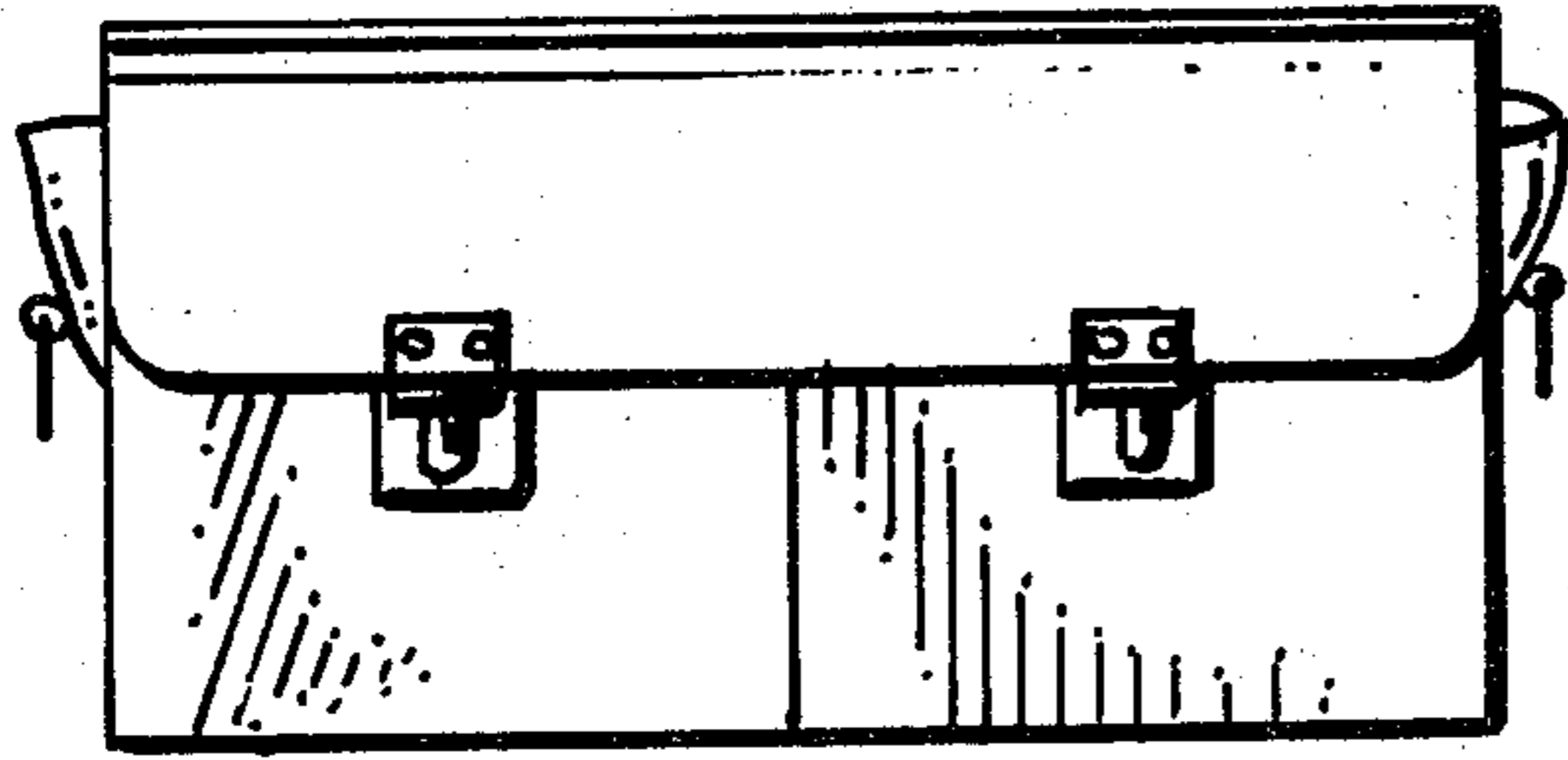

FIG. 1

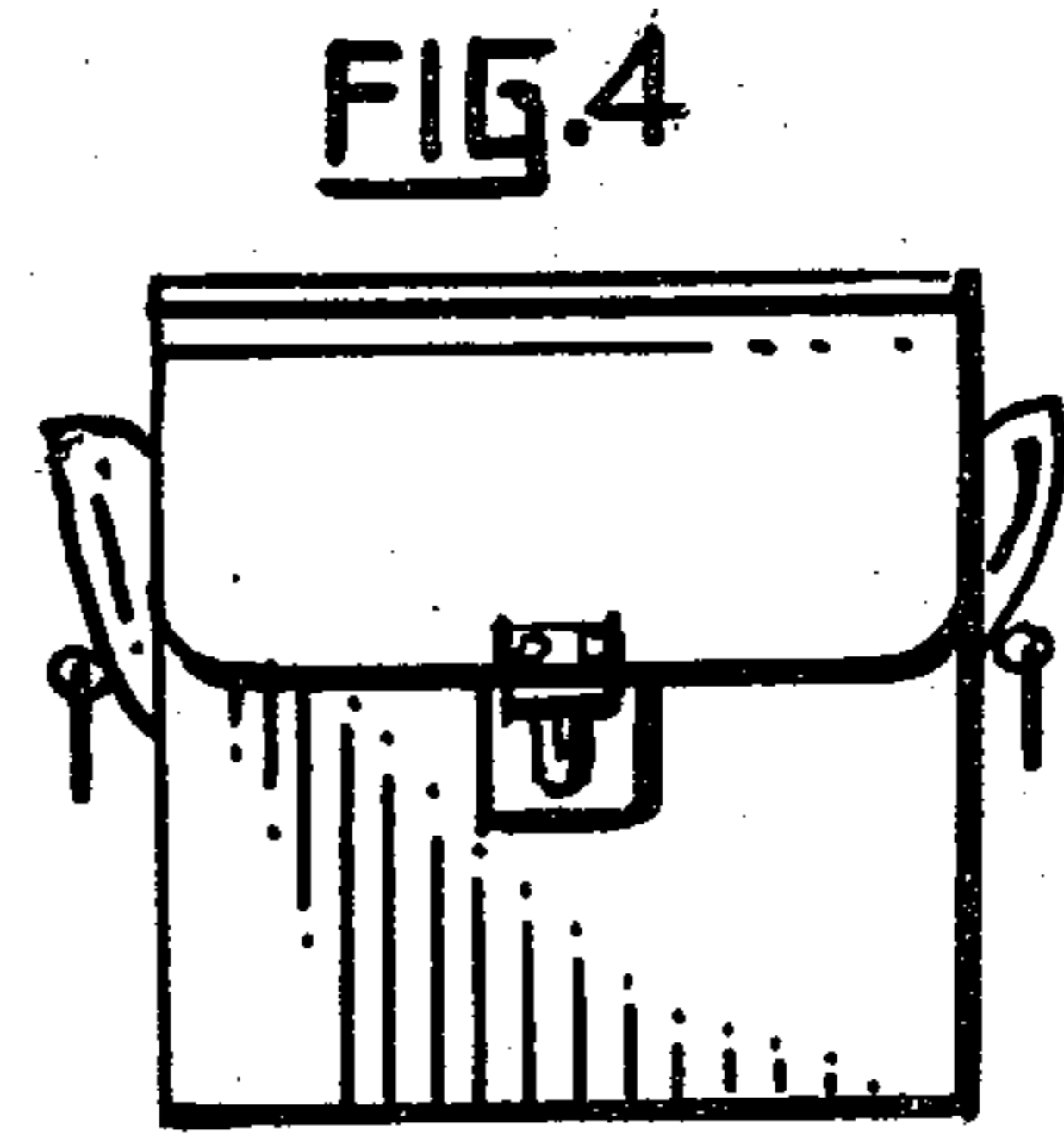

FIG. 4

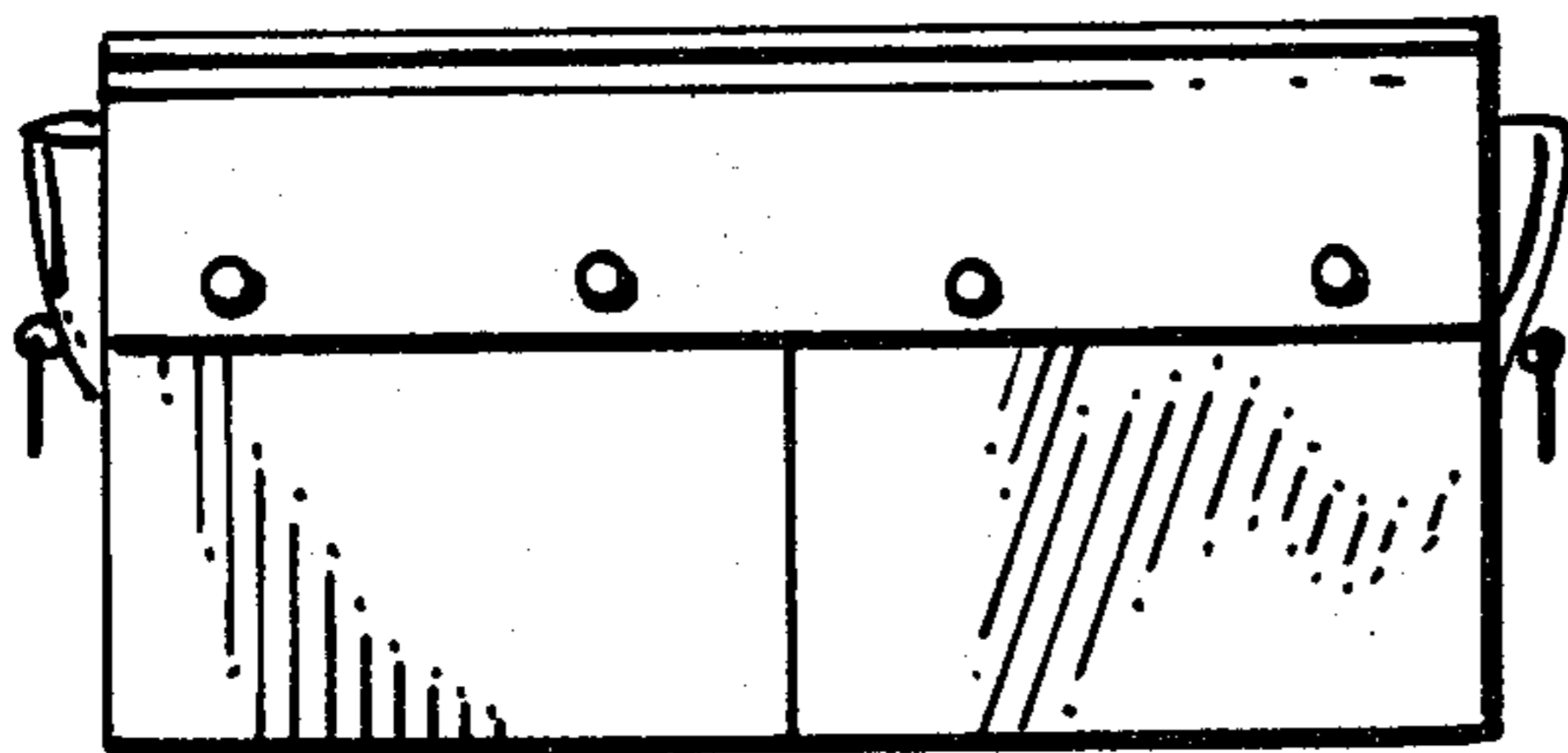

FIG. 2

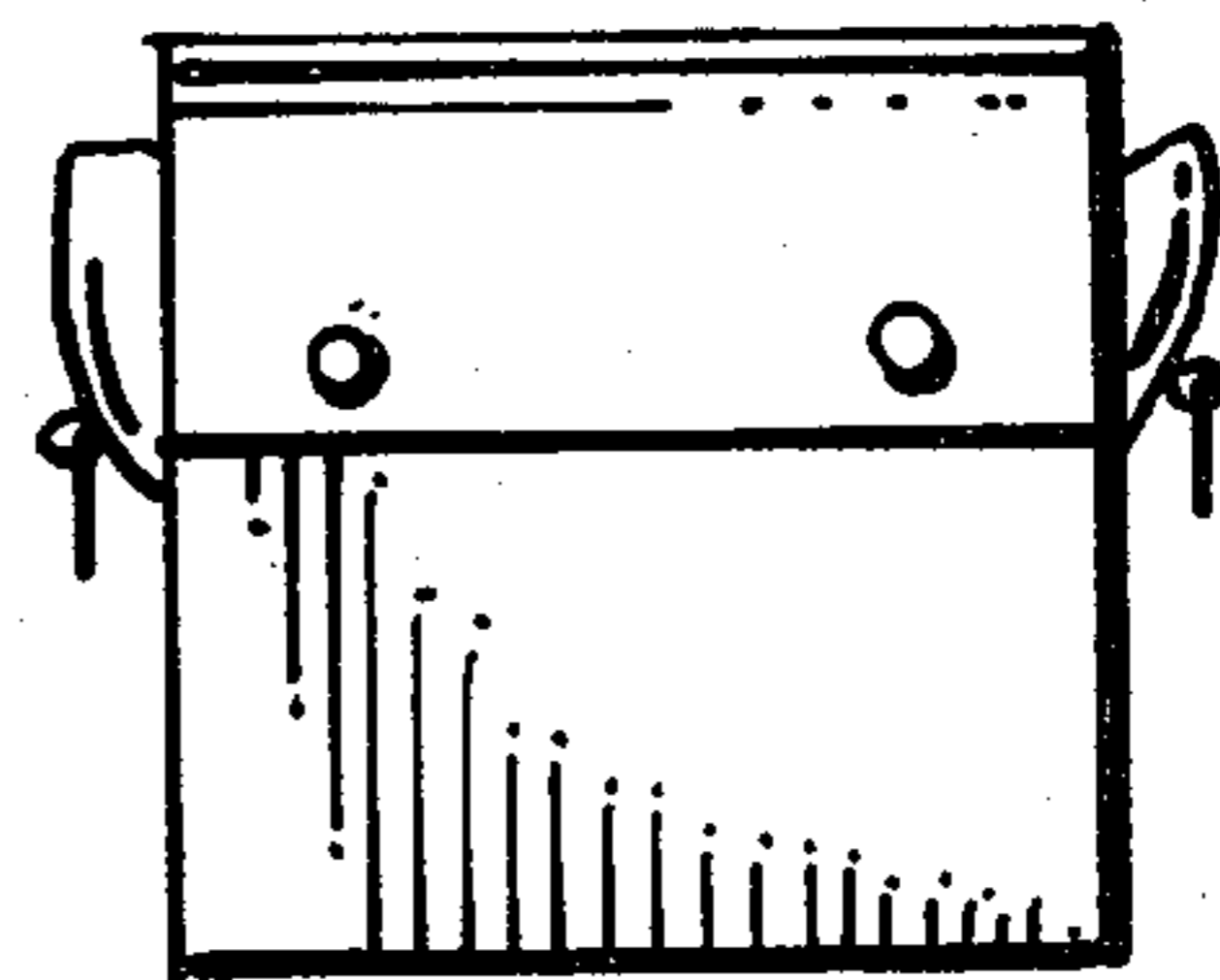

FIG. 5

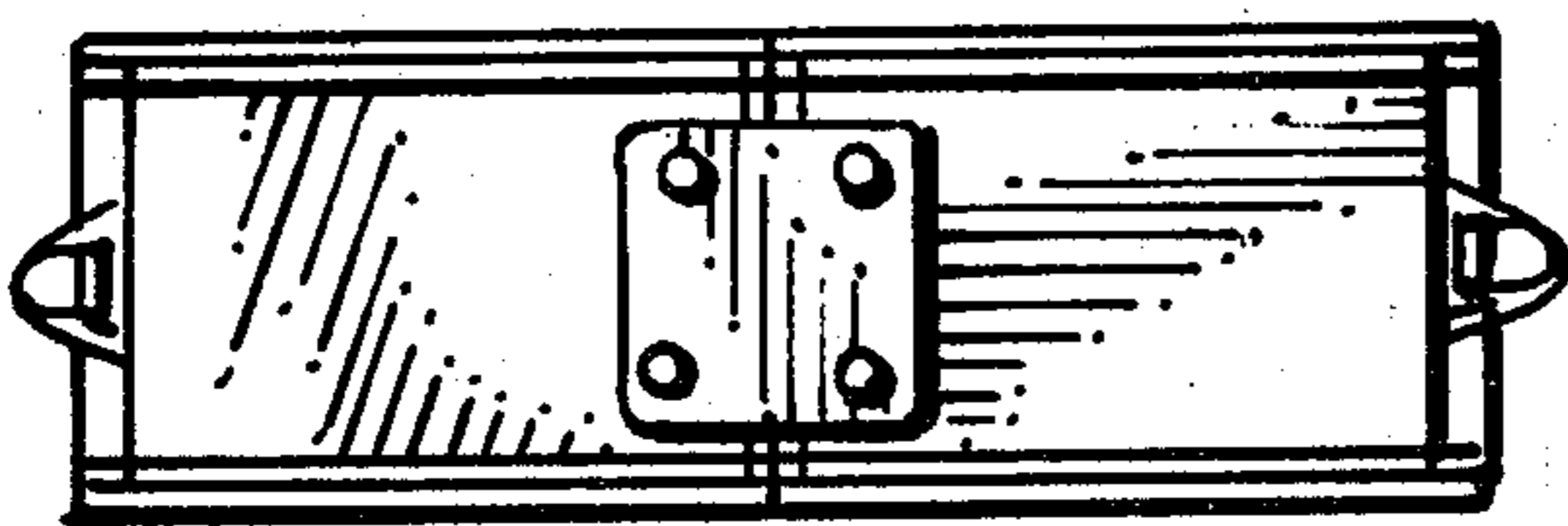

FIG. 3

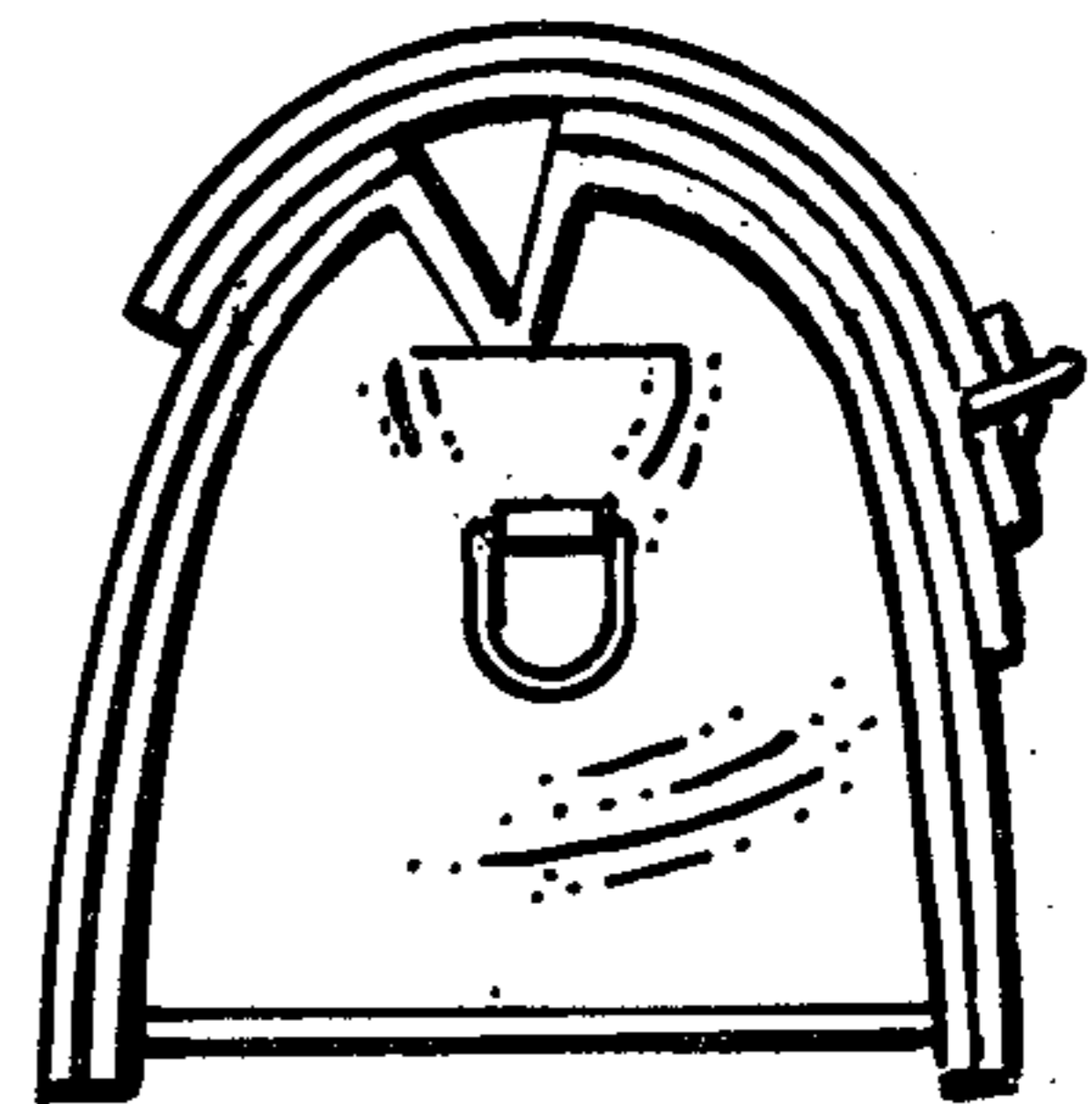
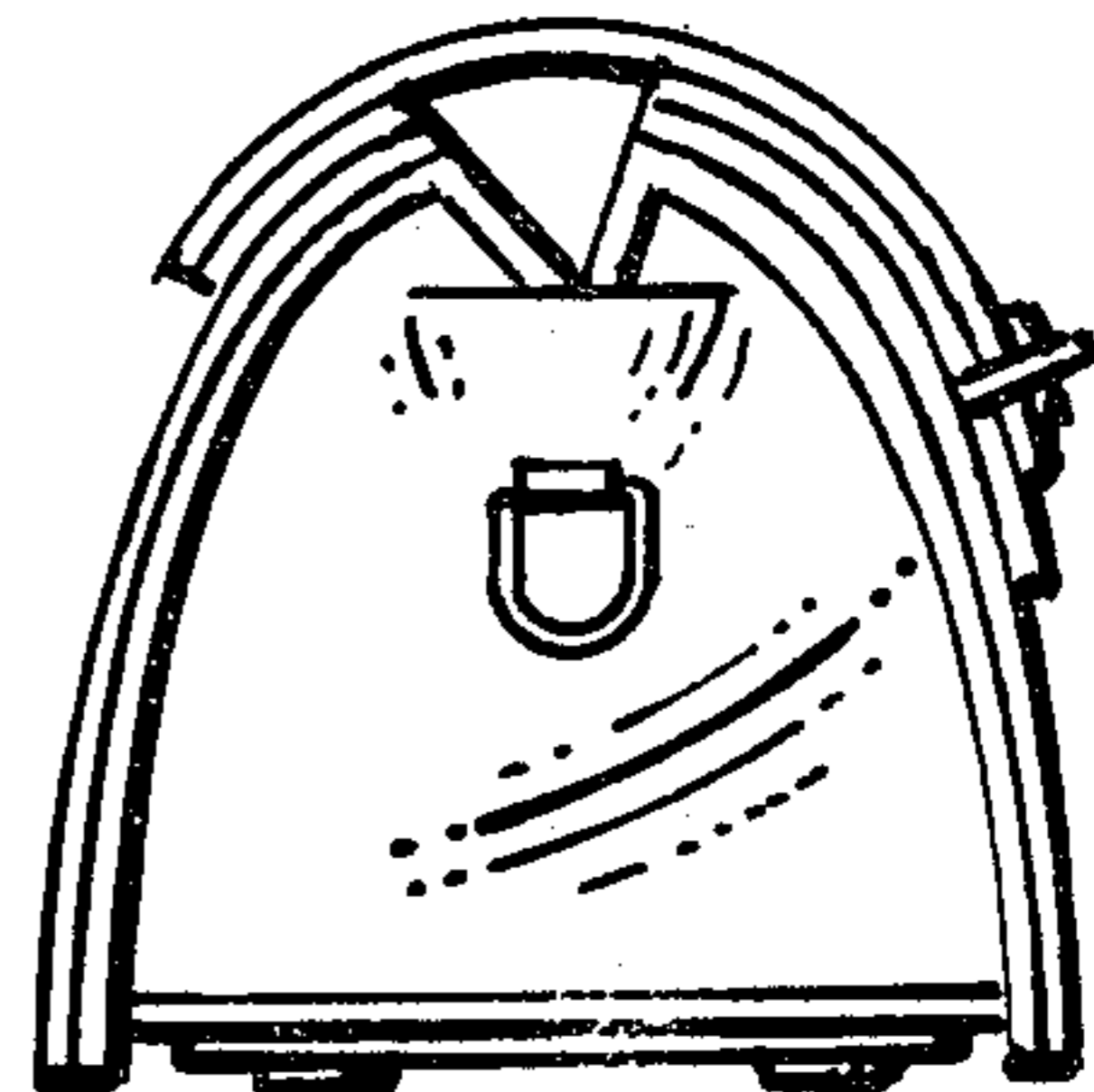

FIG. 6

FIG. 7



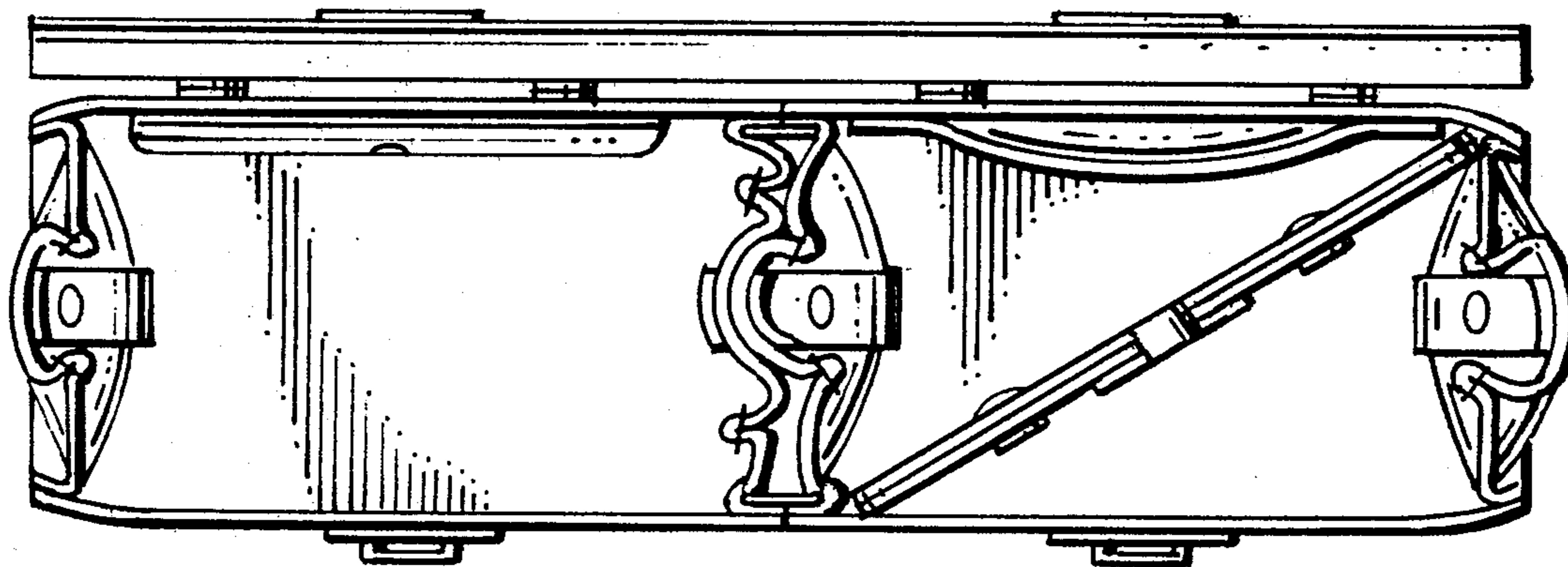
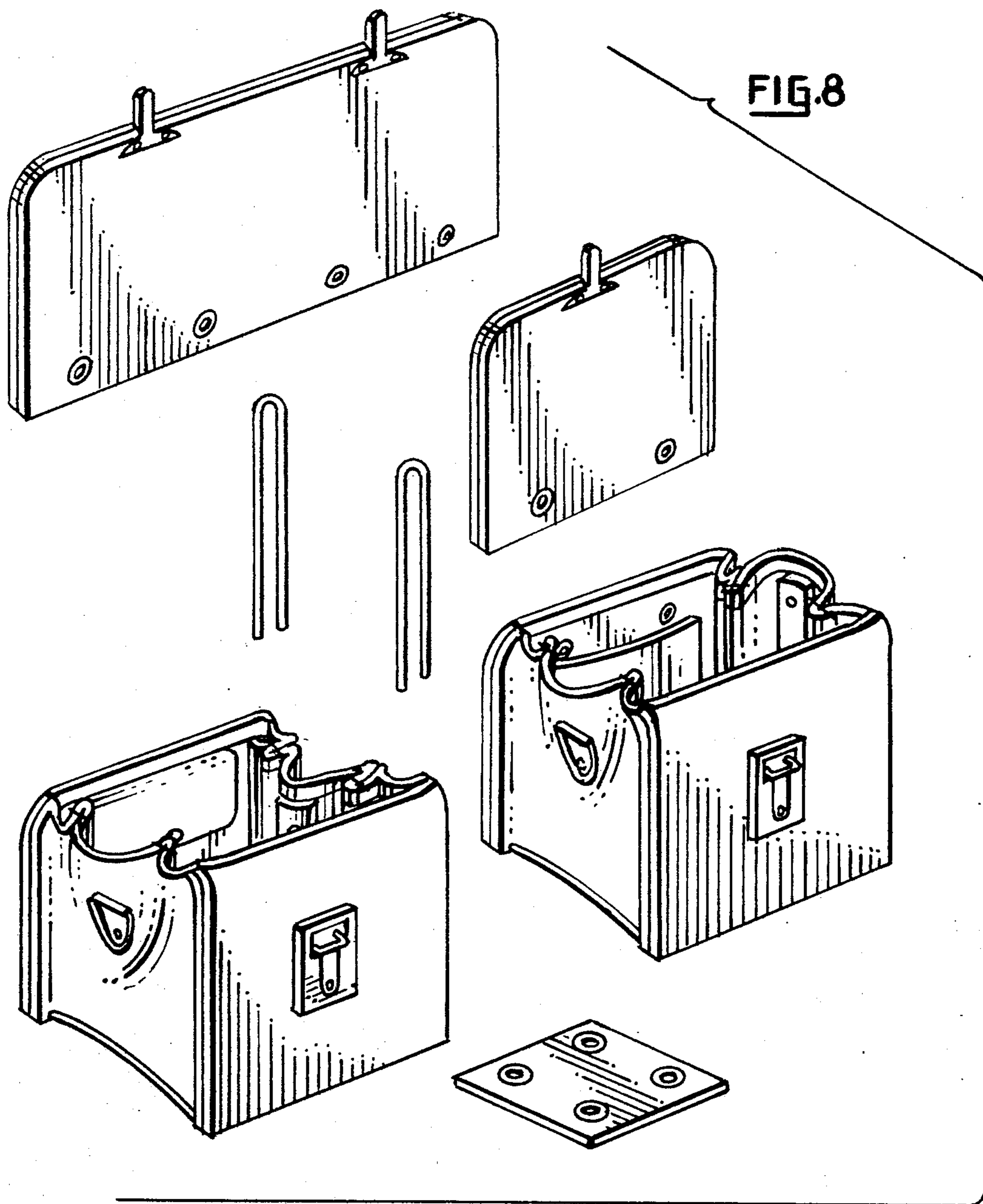

FIG. 9