

[54] WORK PIECE PROTECTING PAD FOR USE ON A BAR CLAMP, OR SIMILAR ARTICLE

[76] Inventor: Erciel F. Lacina, 17645 Arrow Blvd., Fontana, Calif. 92335

[**] Term: 14 Years

[21] Appl. No.: 340,745

[22] Filed: Jan. 19, 1982

[52] U.S. Cl. D8/72

[58] Field of Search D8/72; 269/275, 285

[56] References Cited

U.S. PATENT DOCUMENTS

D. 193,736	10/1962	Yandt	D8/72
2,519,107	8/1950	Brown	269/275
4,052,046	10/1977	Mortoly	269/285 X

OTHER PUBLICATIONS

Adjustable Clamp Co. Condensed Catalog, No. L-20, p. 3, "Pony" Bar Clamp Pads at lower left of page.

Primary Examiner—Alan P. Douglas
Attorney, Agent, or Firm—John H. Crowe

[57] CLAIM

The ornamental design for a work piece protecting pad

for use on a bar clamp, or similar article, substantially as shown and described.

DESCRIPTION

FIG. 1 is an isometric view of a first embodiment of a work piece protecting pad for use on a bar clamp, or similar article, showing my new design.

FIG. 2 is a front elevational view of FIG. 1, drawn to a reduced scale.

FIG. 3 is a top plan view of FIG. 2.

FIG. 4 is a bottom plan view of FIG. 2.

FIG. 5 is a rear elevational view of FIG. 2.

FIG. 6 is a side elevational view of FIG. 2, the opposite side elevational view being a mirror image thereof.

FIG. 7 is an isometric view of a second embodiment of the work piece protecting pad for use on a bar clamp, or similar article.

FIG. 8 is a front elevational view of FIG. 7, drawn to a reduced scale.

FIG. 9 is a top plan view of FIG. 8.

FIG. 10 is a bottom plan view of FIG. 8.

FIG. 11 is a side elevational view of FIG. 8, the opposite side elevational view being a mirror image thereof.

FIG. 12 is a rear elevational view of FIG. 8.

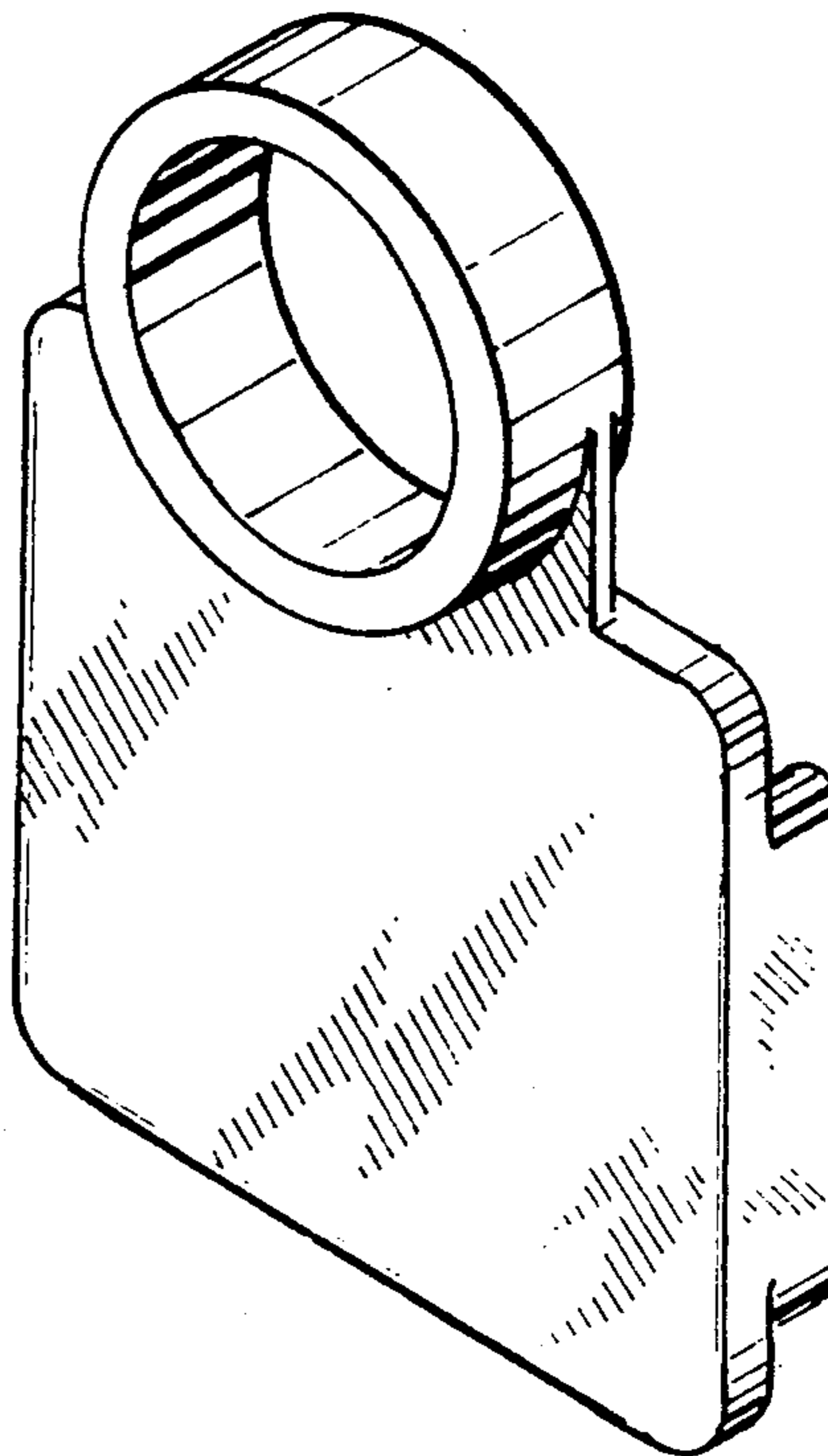
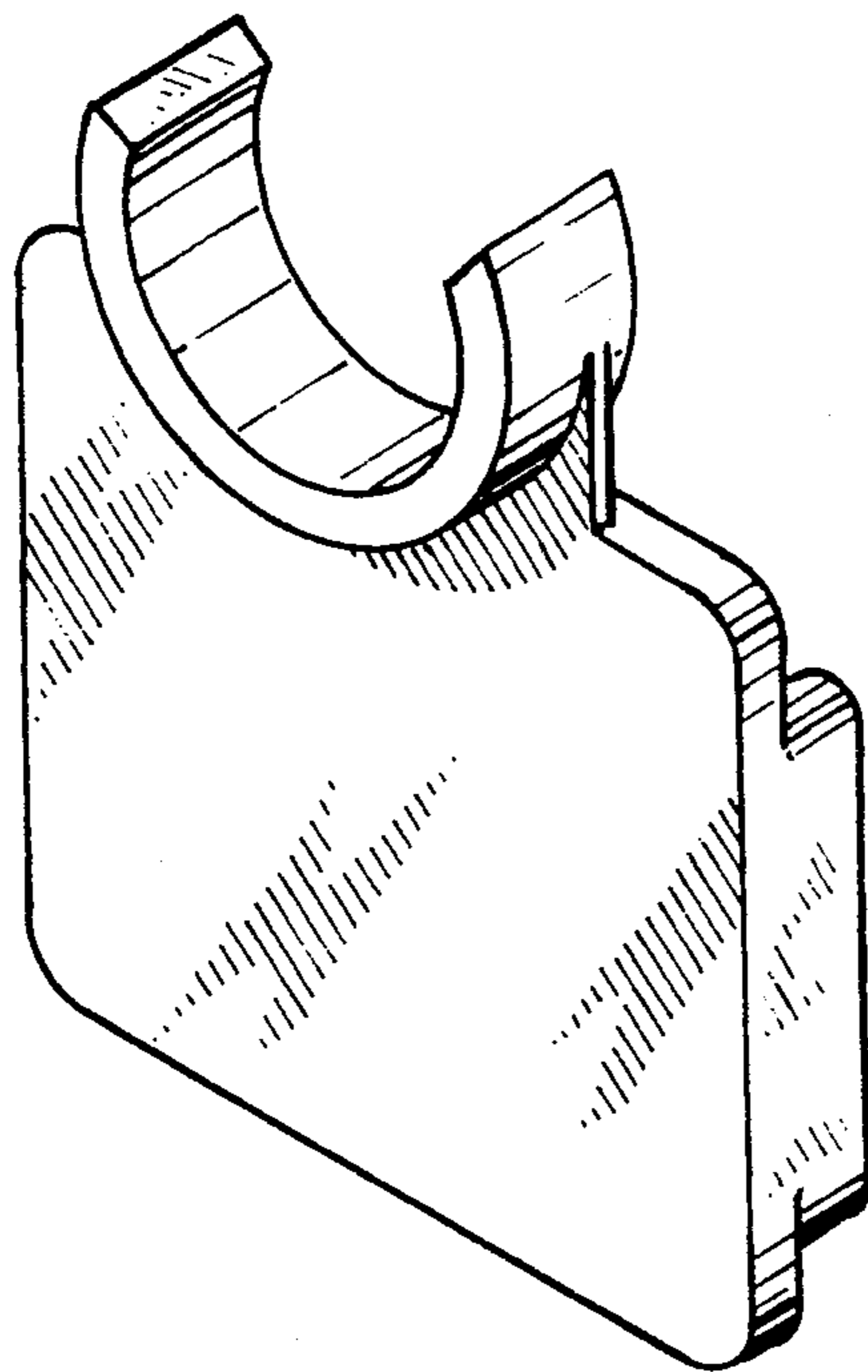

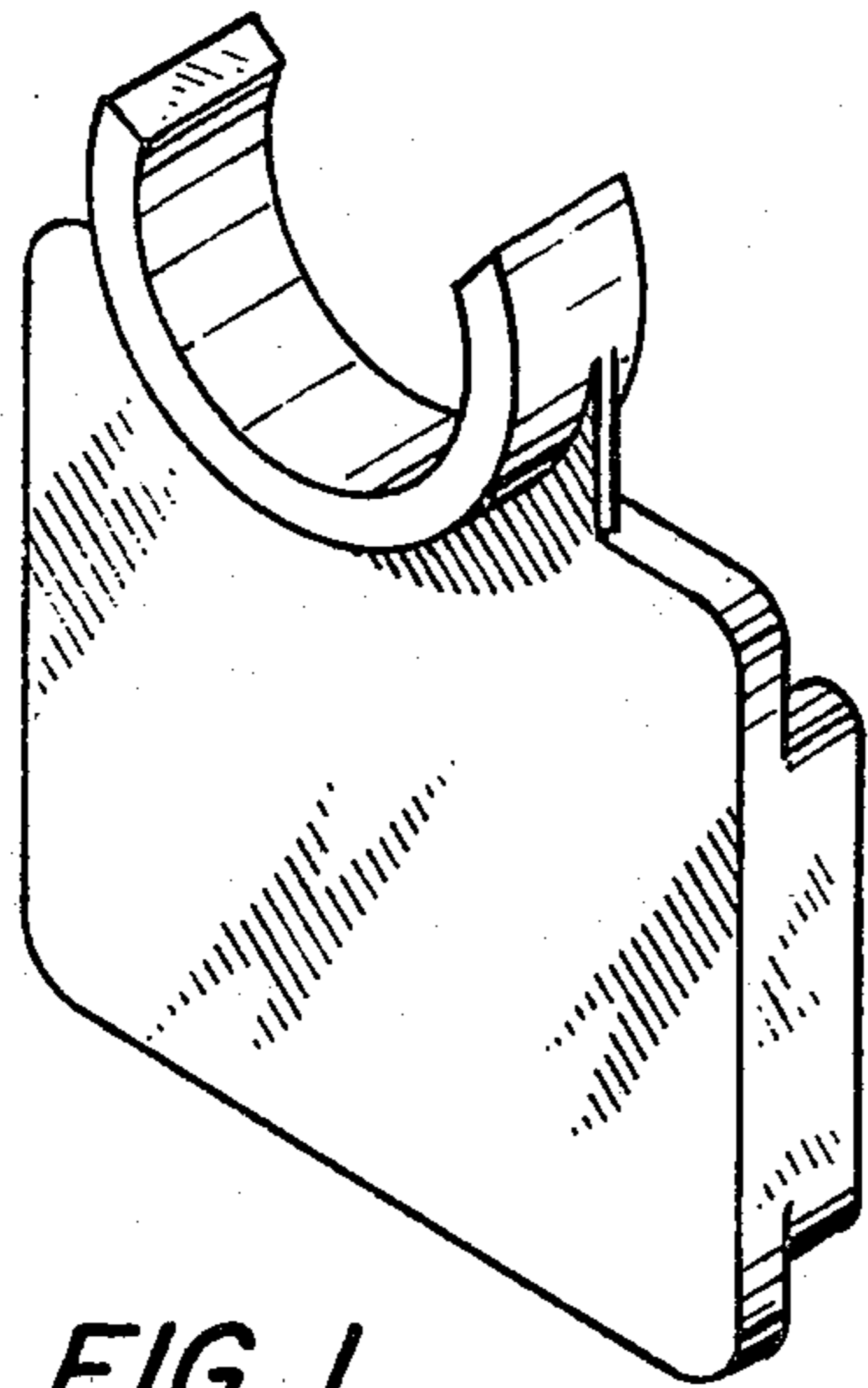

FIG. 1



FIG. 3

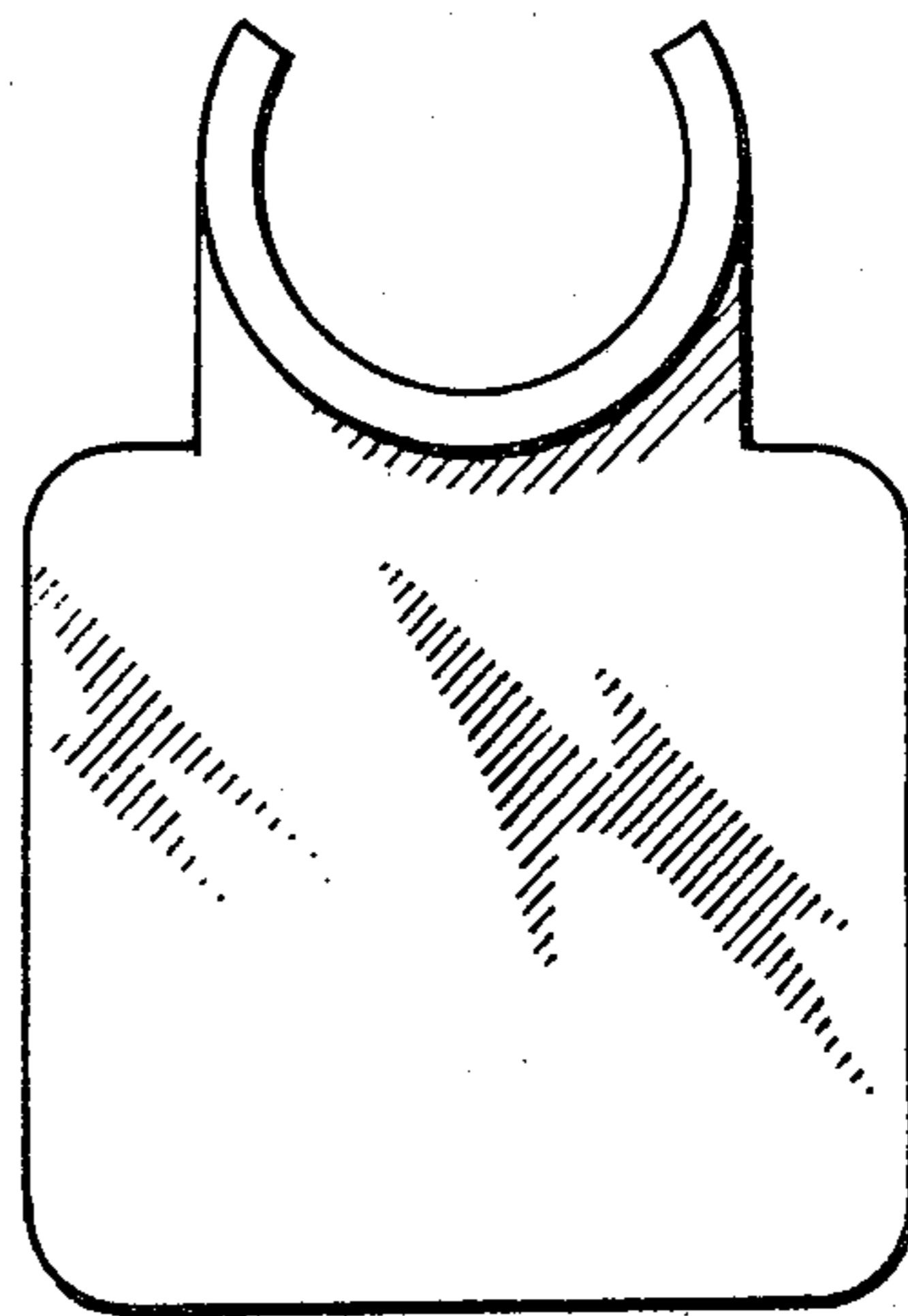

FIG. 2

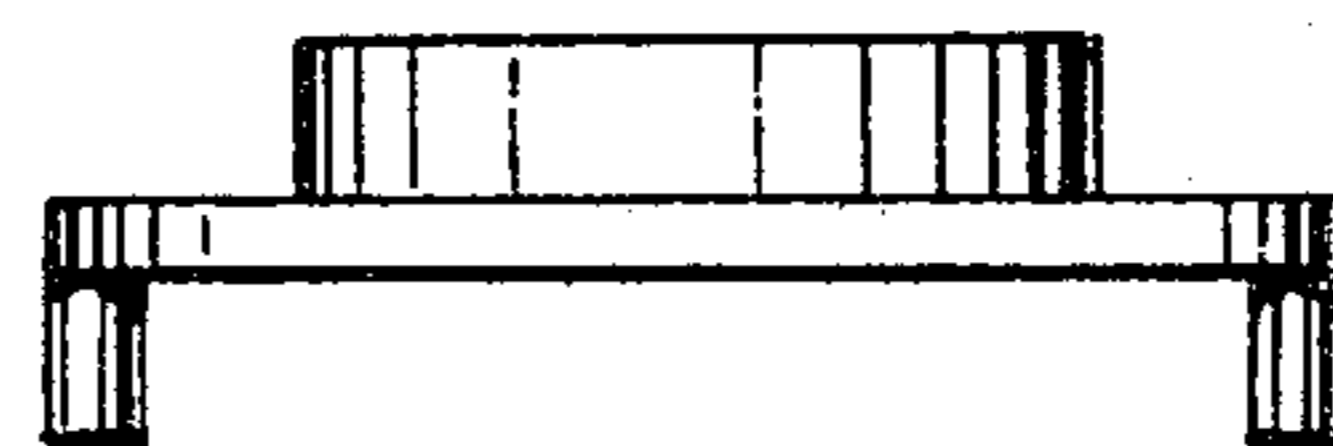

FIG. 4



FIG. 6

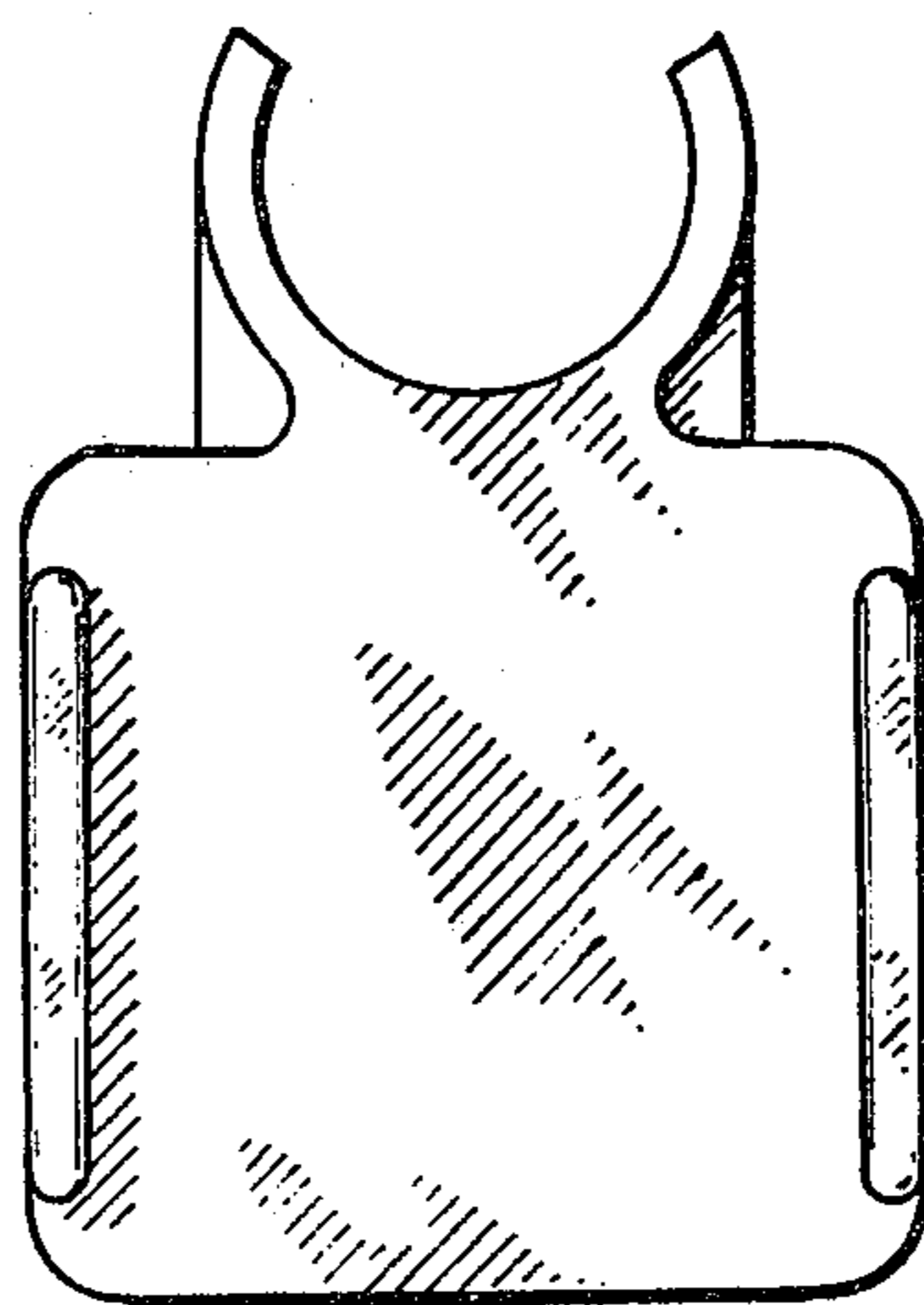

FIG. 5

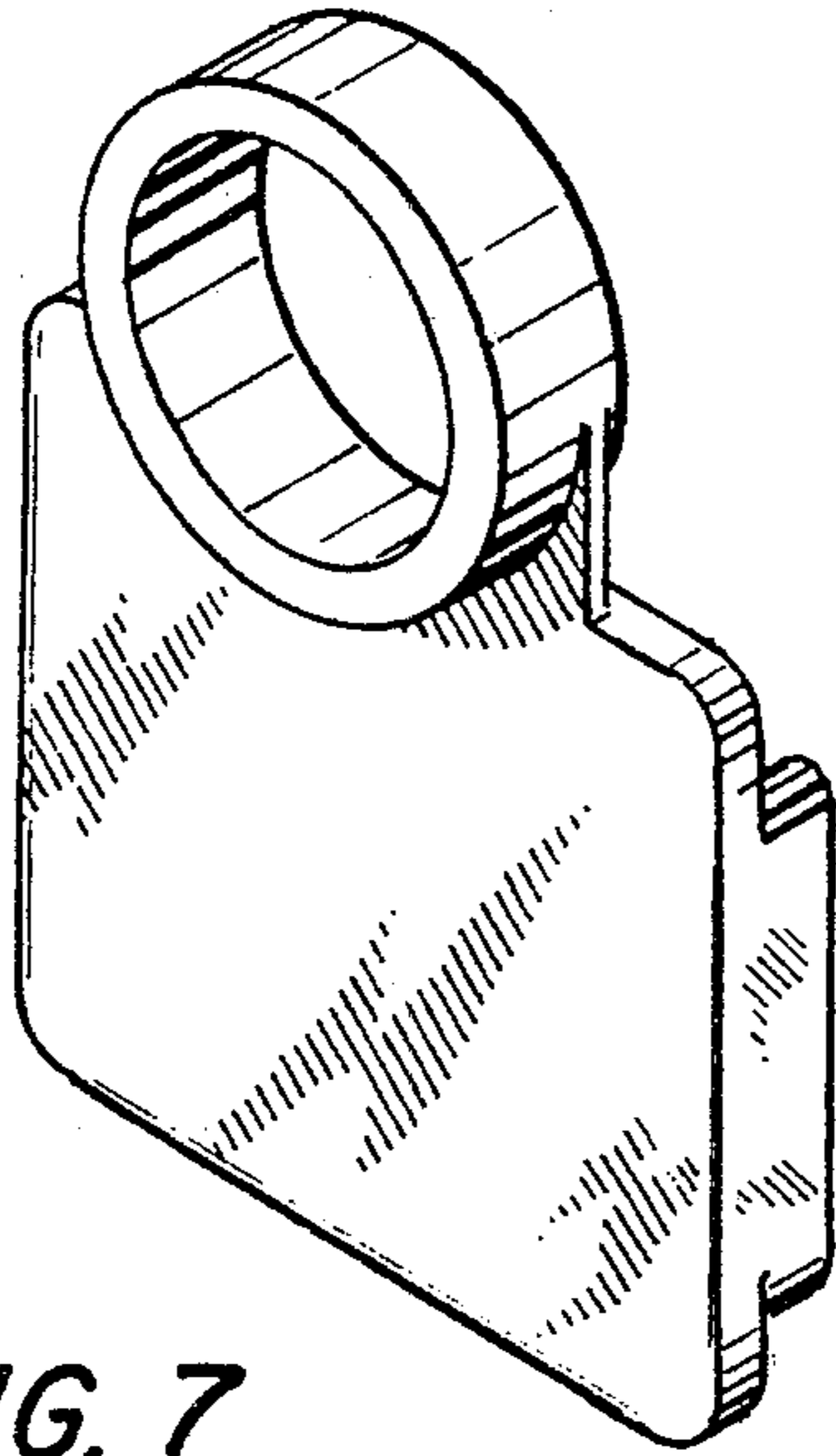

FIG. 7

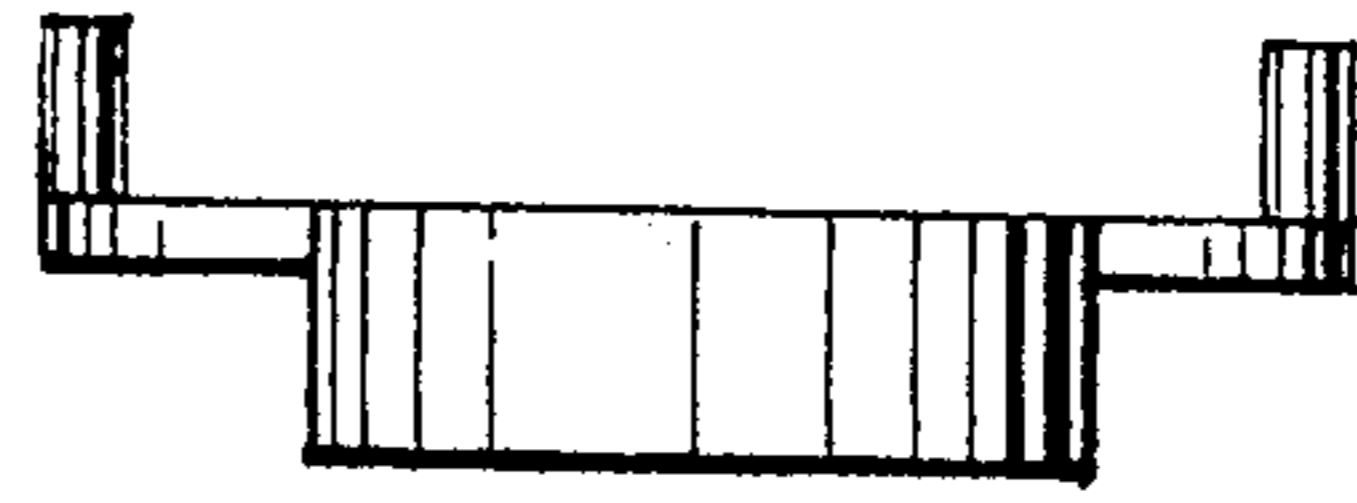

FIG. 9

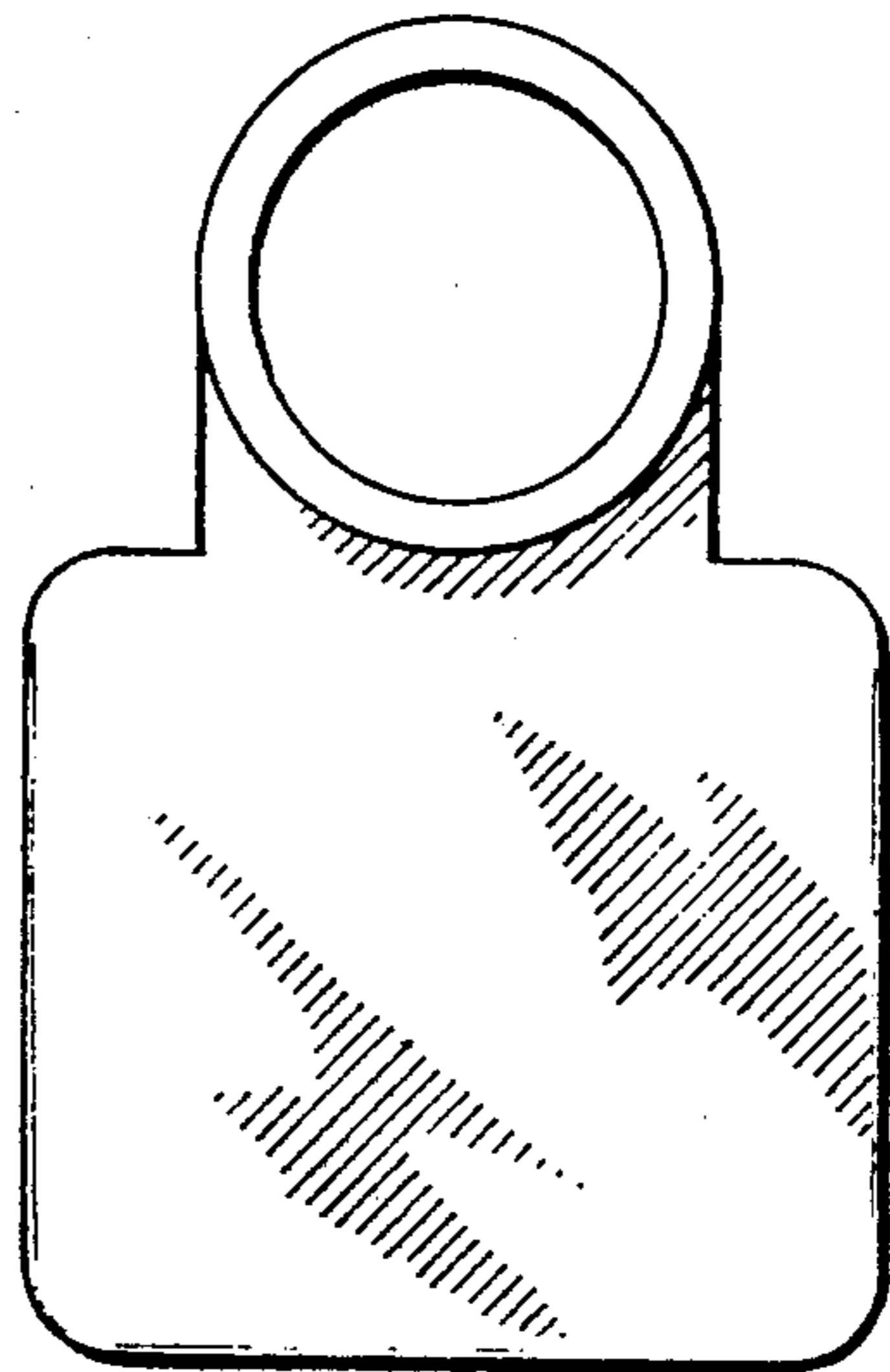

FIG. 8

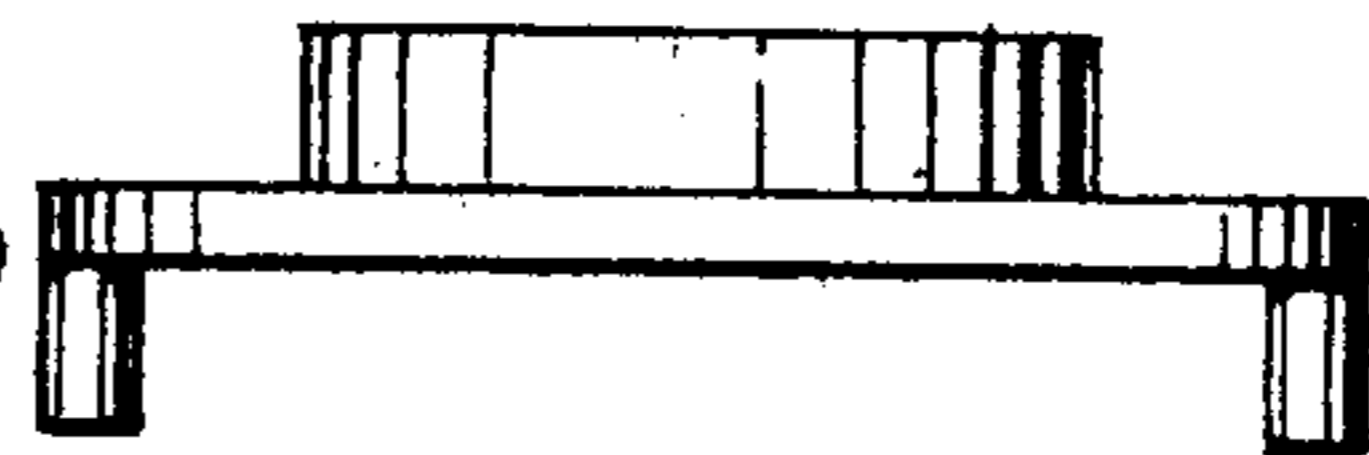

FIG. 10

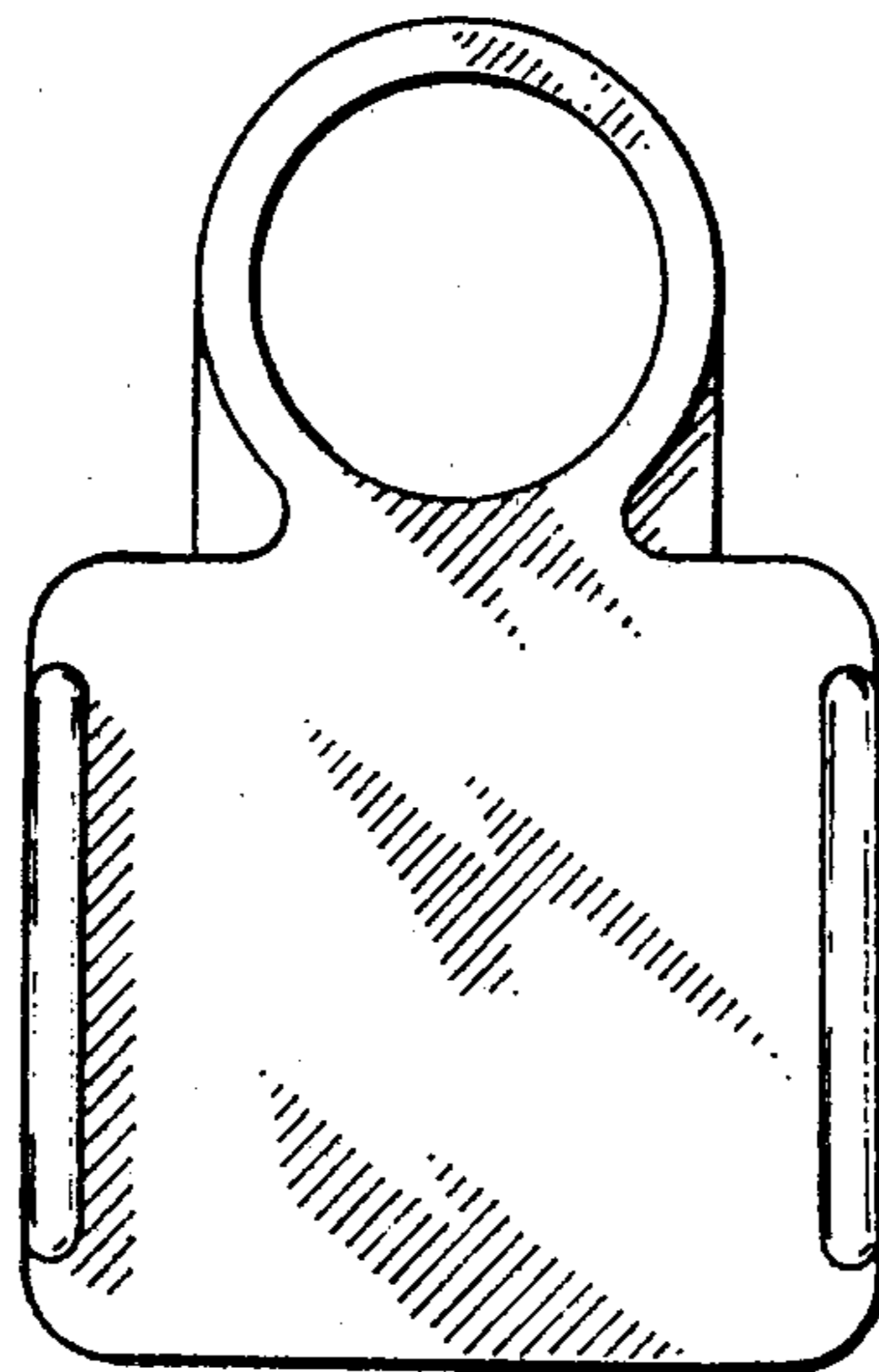

FIG. 12

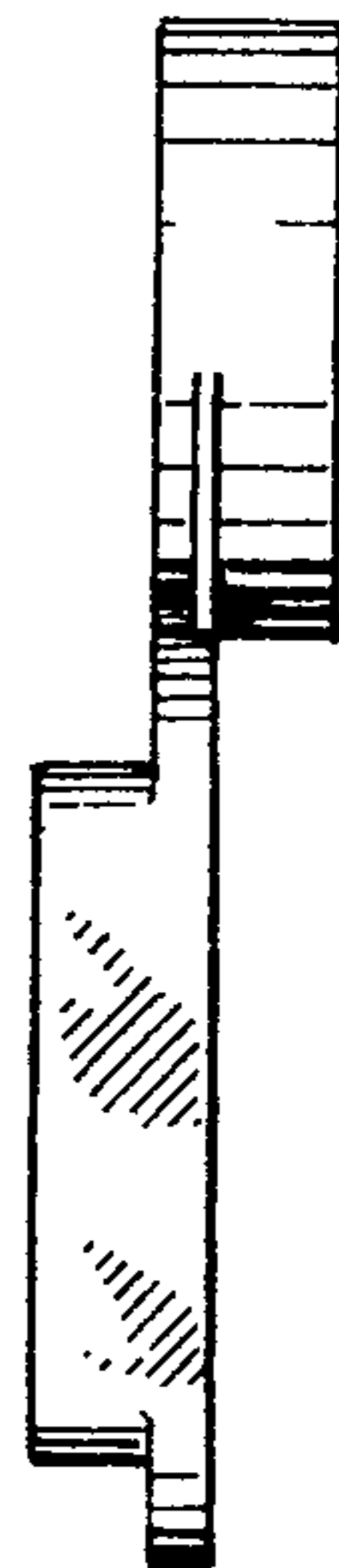

FIG. 11