

[54] THERAPEUTIC INVERSION DEVICE

[76] Inventor: Wayne H. McGowen, 4930 Mill
Creek, Dallas, Tex. 75234

[**] Term: 14 Years

[21] Appl. No.: 472,228

[22] Filed: Mar. 4, 1983

[52] U.S. Cl. D24/3; D21/191

[58] Field of Search D21/191-199;
272/93, 109, 67, 119, 125, 136, 143, 144, 145,
68; D24/3; 128/70-74, 24 R

[56] References Cited

U.S. PATENT DOCUMENTS

D. 269,701	7/1983	Miller	D24/3
3,568,669	3/1971	Sites	128/71
3,589,358	6/1971	Megal	128/71
4,232,662	11/1980	Barber	128/71

FOREIGN PATENT DOCUMENTS

1147158	4/1963	Fed. Rep. of Germany	128/71
445717	2/1968	Switzerland	128/71

Primary Examiner—Charles A. Rademaker
Attorney, Agent, or Firm—Hubbard, Thurman, Turner
& Tucker

[57] CLAIM

The ornamental design for a therapeutic inversion de-
vice, as shown and described.

DESCRIPTION

FIG. 1 is a perspective view of a therapeutic inversion
device showing my new design;
FIG. 2 is a top plan view thereof;
FIG. 3 is a right side elevational view thereof;
FIG. 4 is a bottom plan view thereof;
FIG. 5 is a front elevational view thereof; and,
FIG. 6 is a rear elevational view thereof.

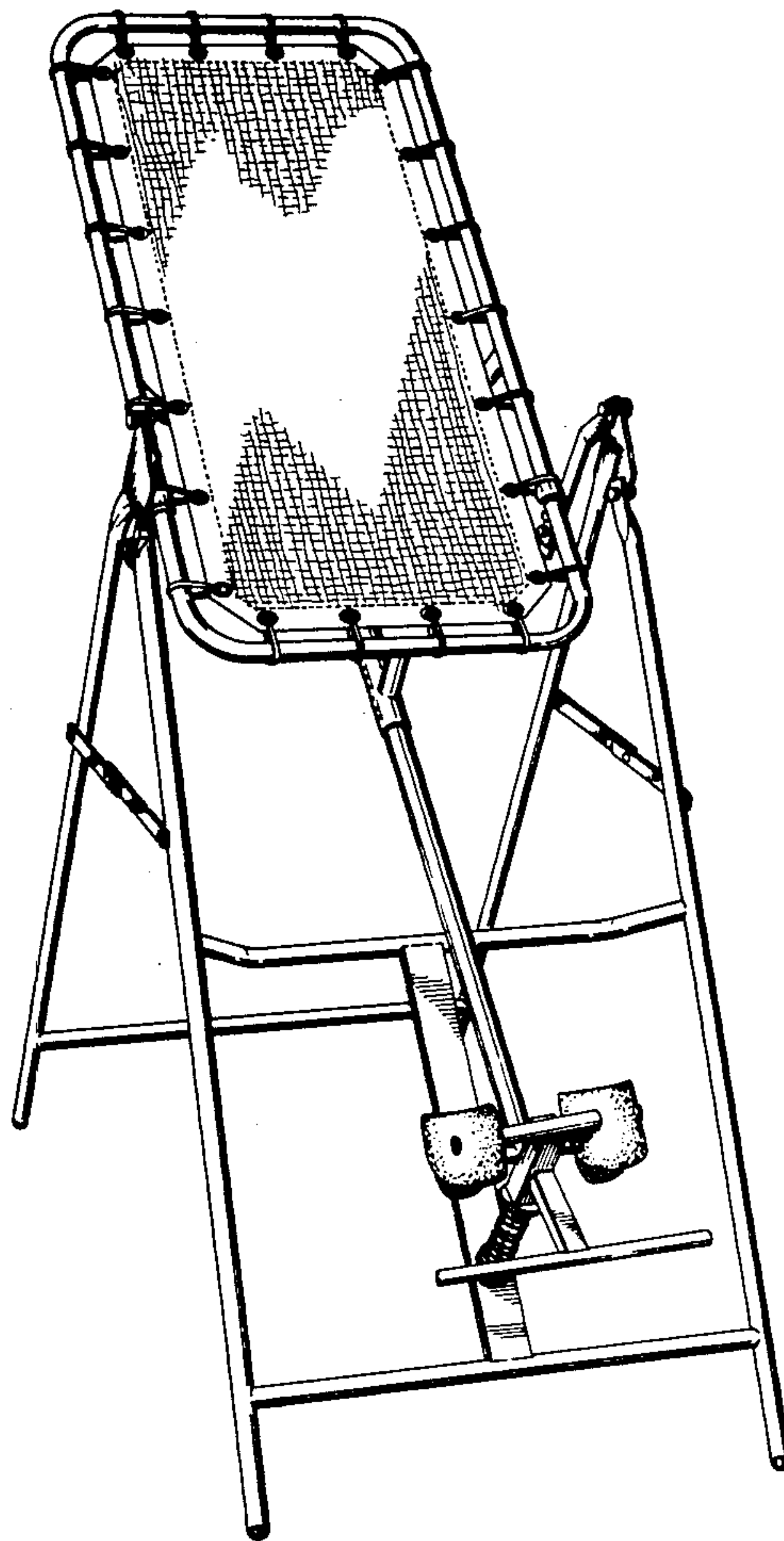

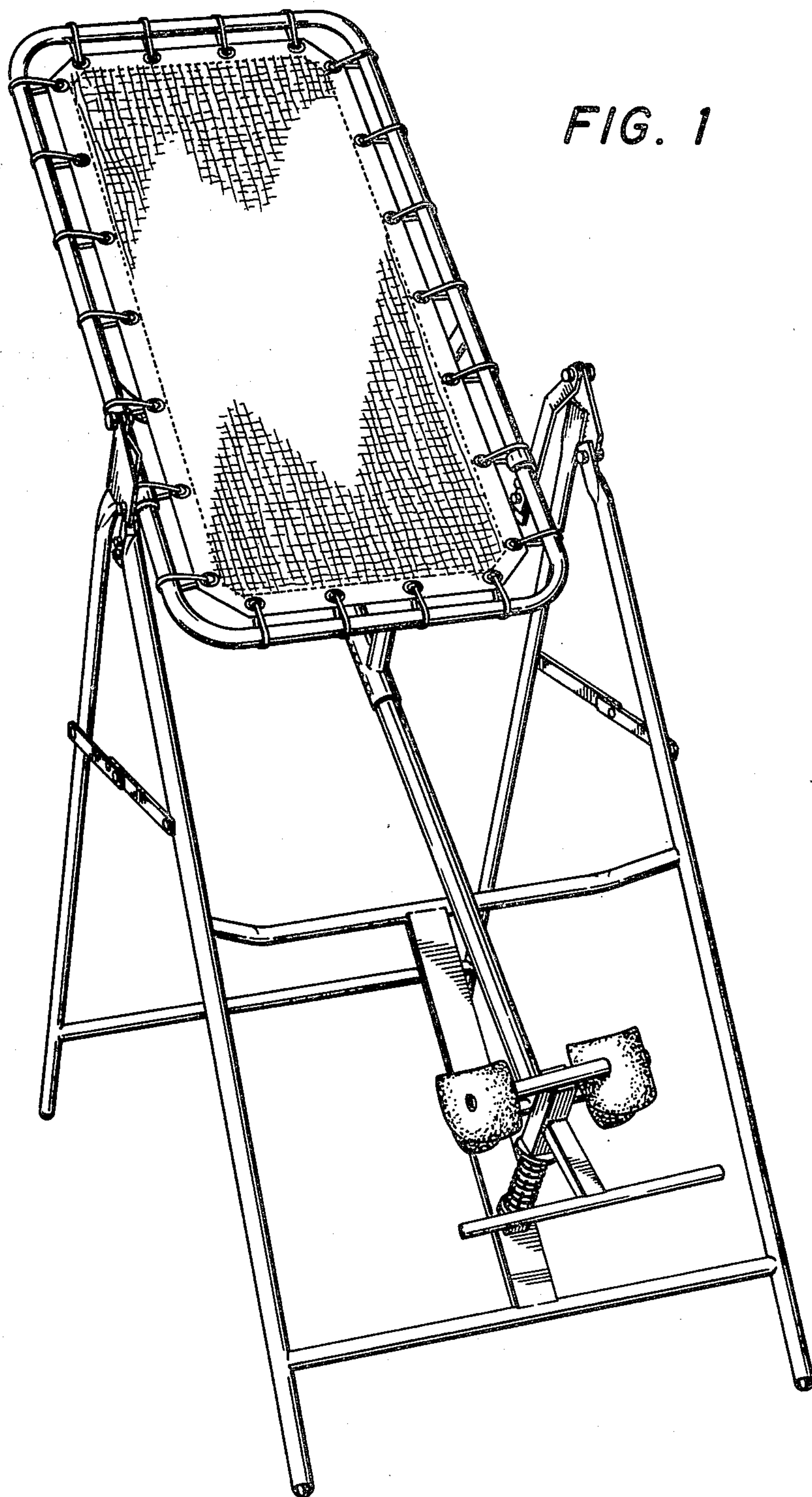

FIG. 1

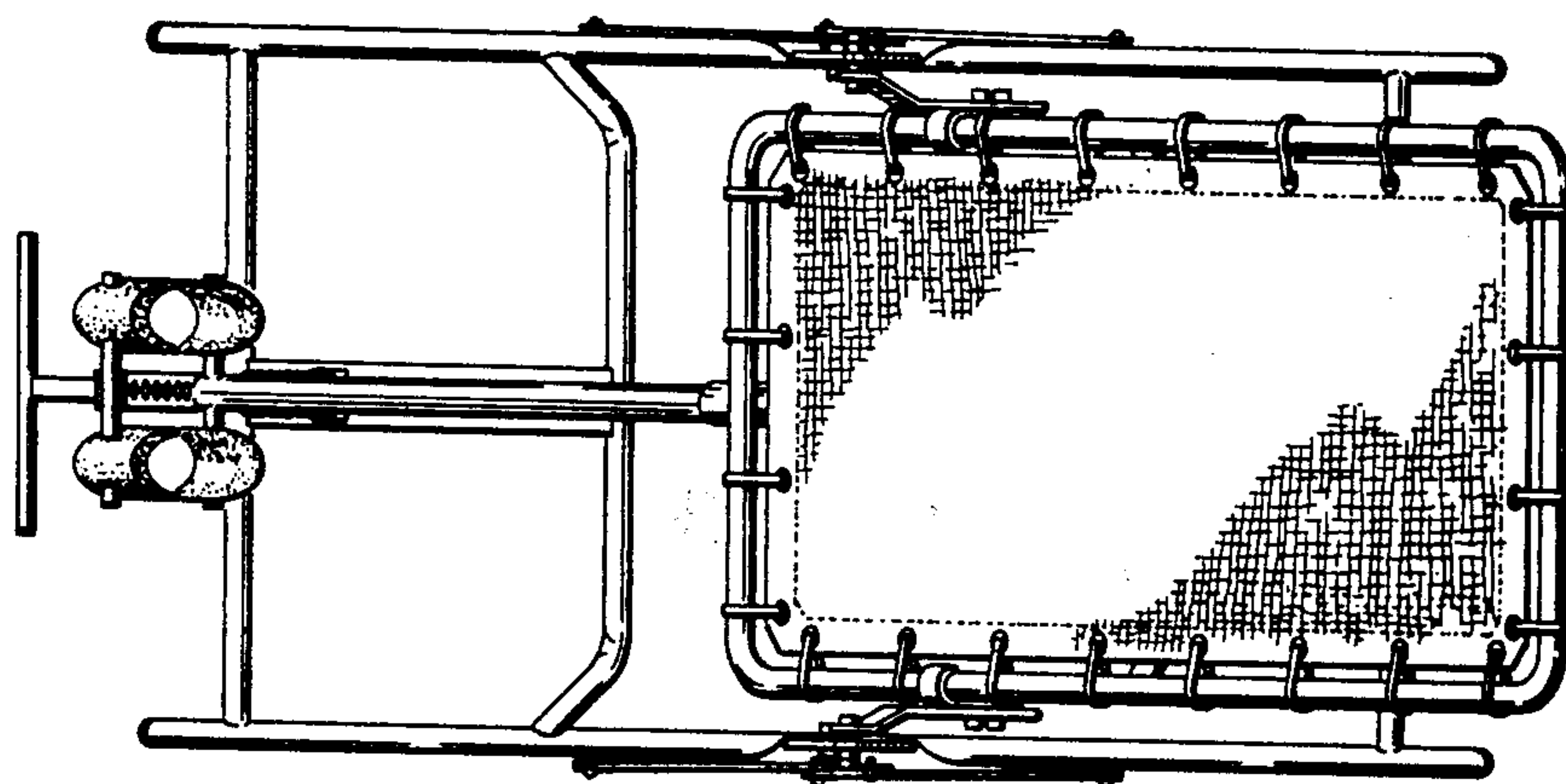

FIG. 2

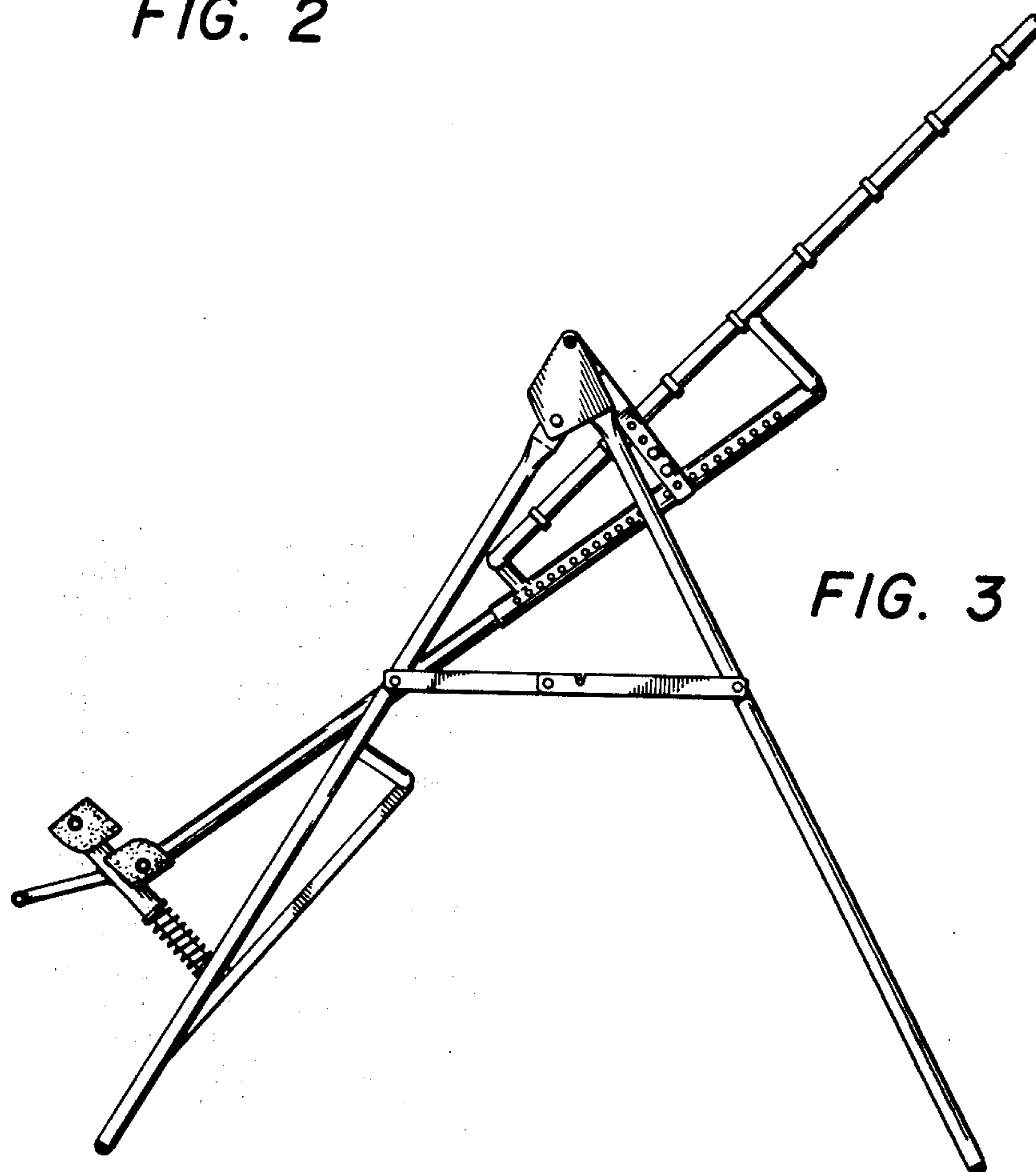

FIG. 3

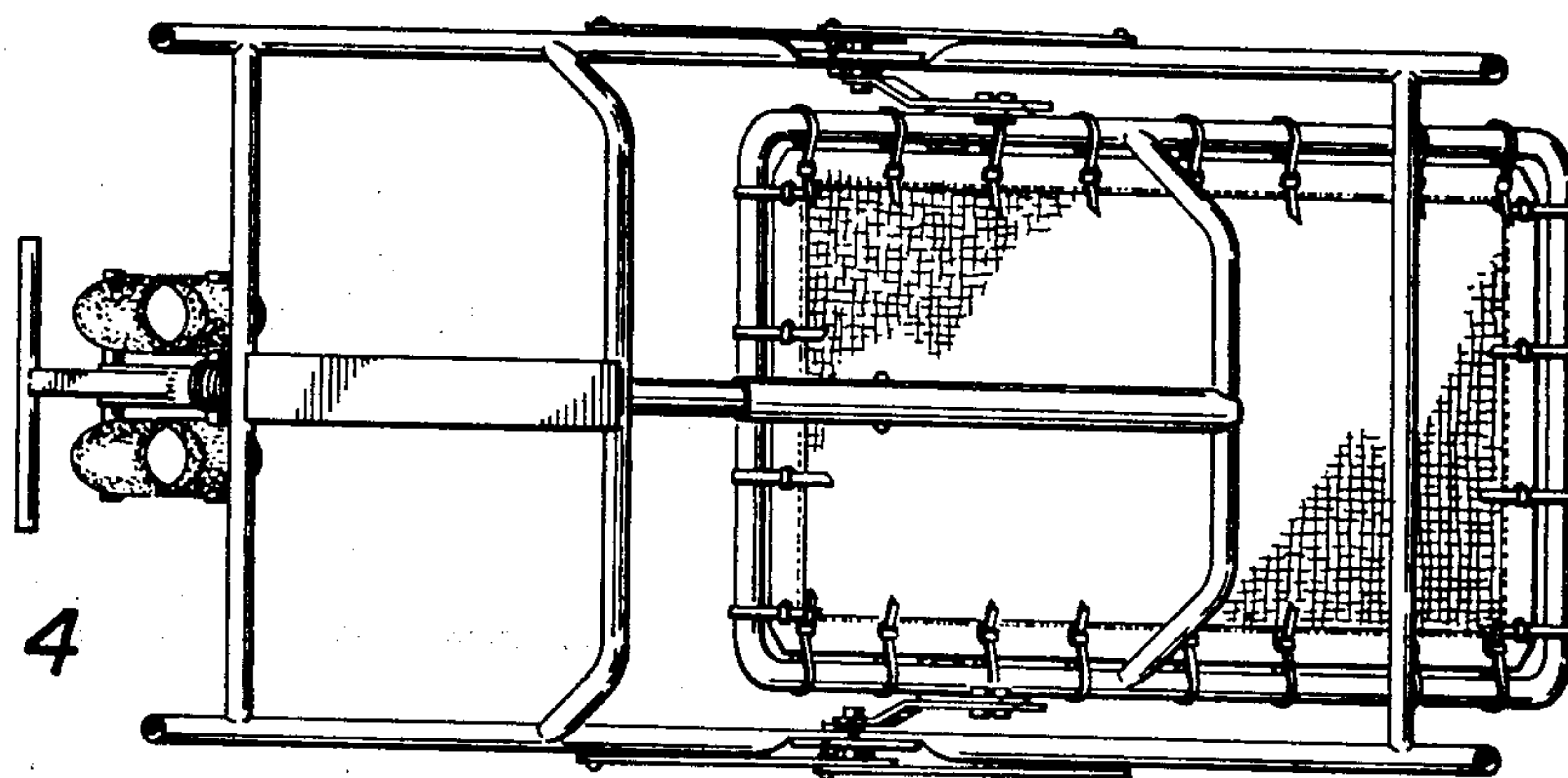

FIG. 4

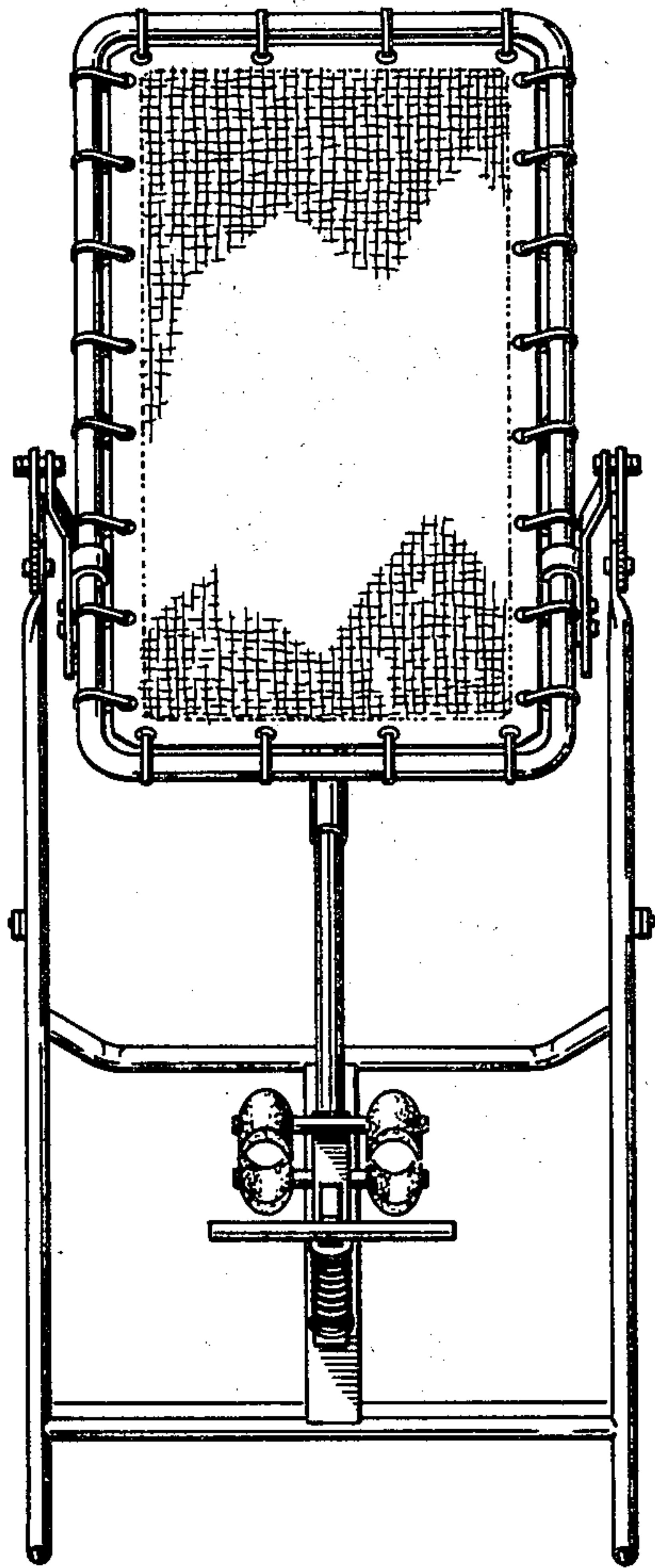

FIG. 5

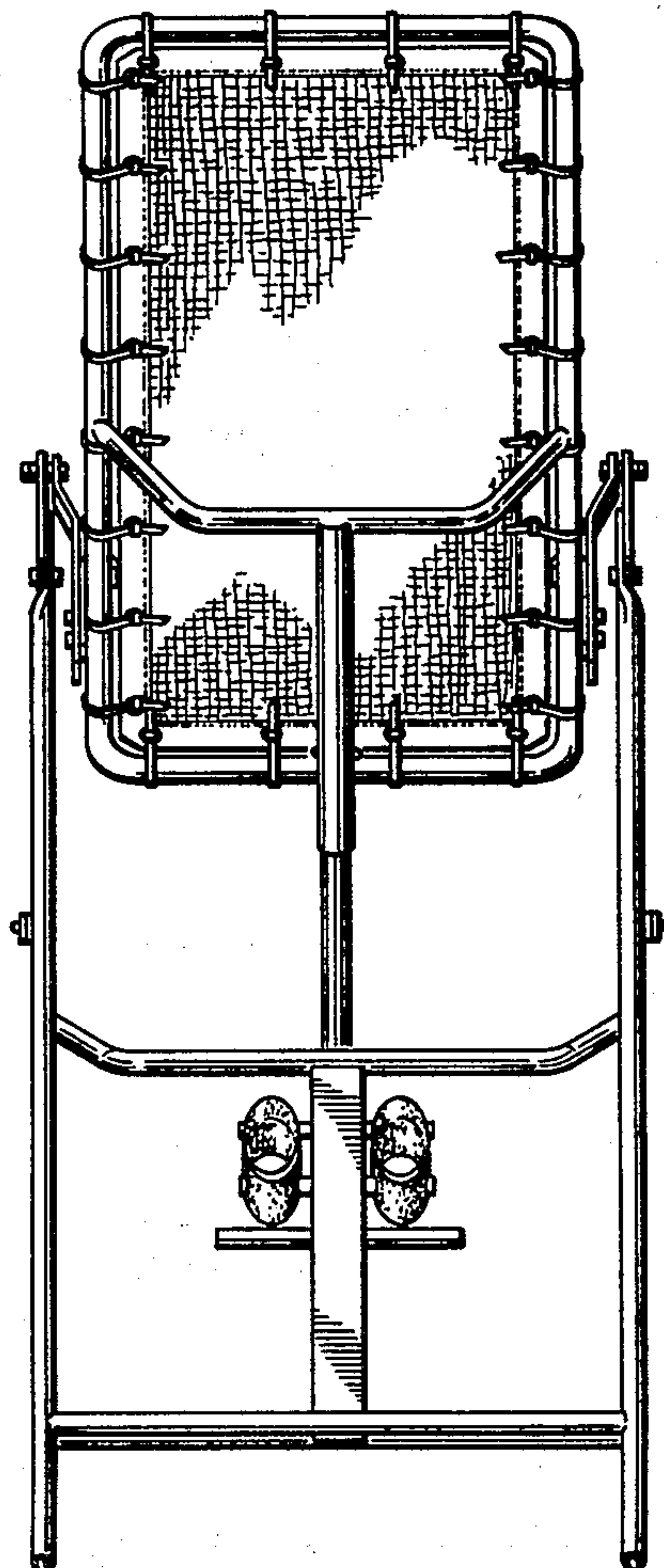

FIG. 6