

[54] FOOD BOWL

[75] Inventor: Lawrence M. Knutson, Prior Lake, Minn.

[73] Assignee: Decra Stone, Inc., Prior Lake, Minn.

[**] Term: 14 Years

[21] Appl. No.: 161,313

[22] Filed: Jun. 20, 1980

[52] U.S. Cl. D7/1; D7/38

[58] Field of Search D7/1, 37, 38, 41, 3, D7/85; D9/424, 431, 432, 425, 341, 347

[56] References Cited

U.S. PATENT DOCUMENTS

D. 35,040	9/1901	Handy	D7/85
D. 115,205	6/1939	Heisey	D7/35
D. 115,818	7/1939	Heisey	D7/21
D. 137,512	3/1944	Laure	D9/341

D. 223,189	3/1972	Dittman	D9/425
D. 240,355	6/1976	Chadbourne	D9/425

Primary Examiner—Winifred E. Herrmann
Attorney, Agent, or Firm—Williamson, Bains, Moore & Hansen

[57] CLAIM

The ornamental design for the food bowl, as shown and described.

DESCRIPTION

FIG. 1 is a top plan view of a food bowl showing my new design;
FIG. 2 is a front or rear elevational view thereof;
FIG. 3 is a bottom plan view thereof;
FIG. 4 is a right or left side elevational view thereof;
FIG. 5 is a cross-sectional view thereof taken along cutting plane 5—5 of FIG. 1.
FIG. 6 is a side cross-sectional view thereof taken along cutting plane 6—6 of FIG. 2.

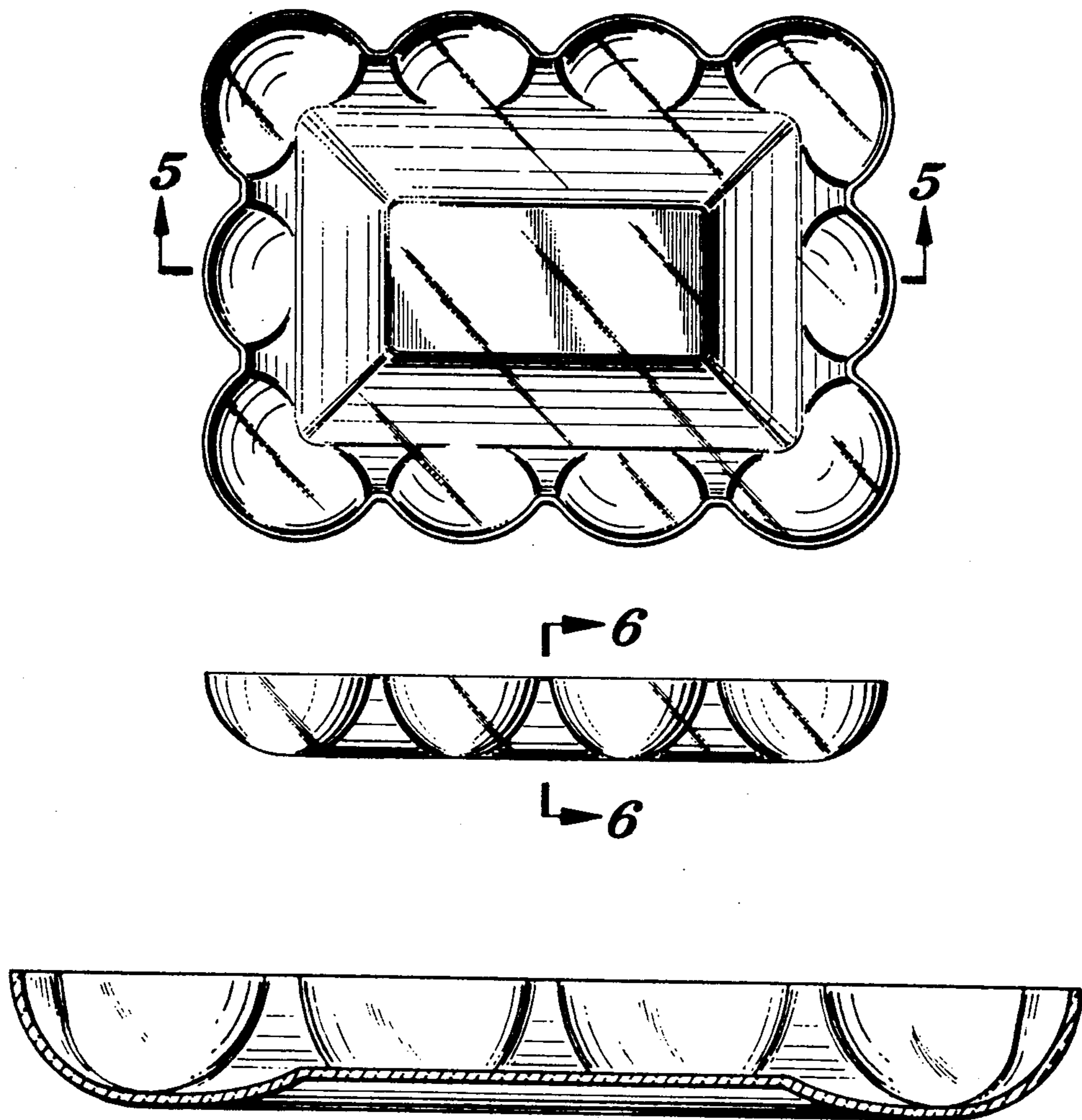

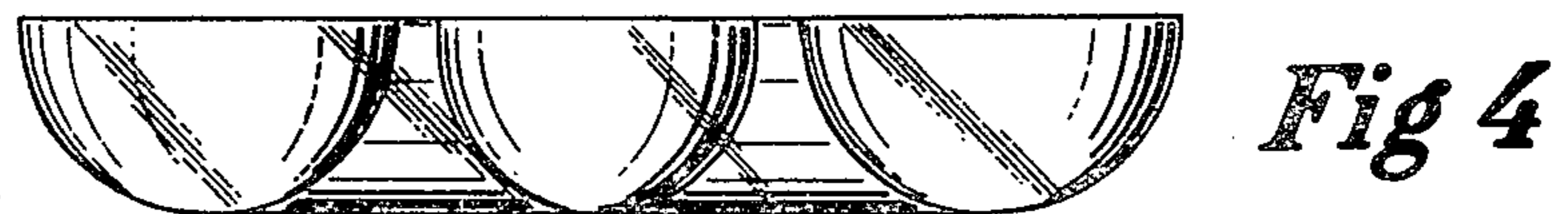
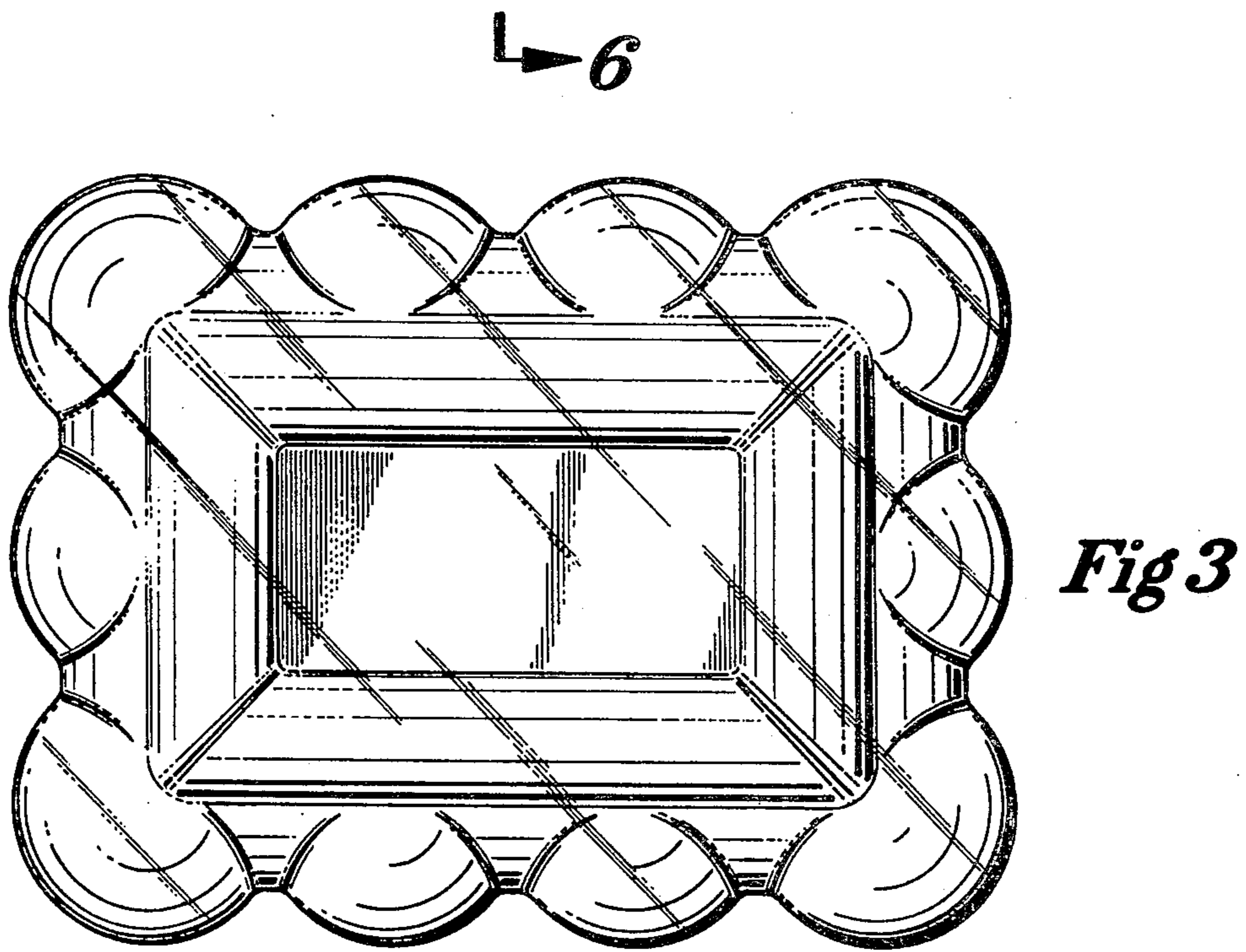
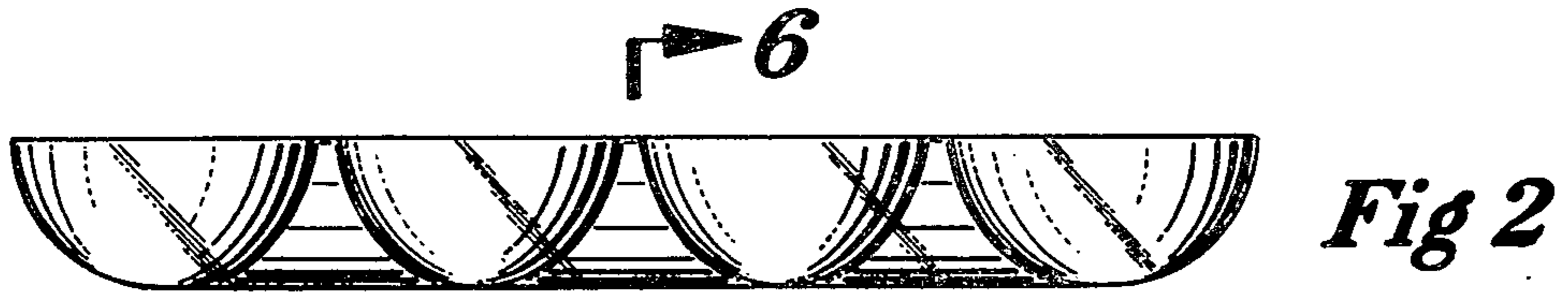
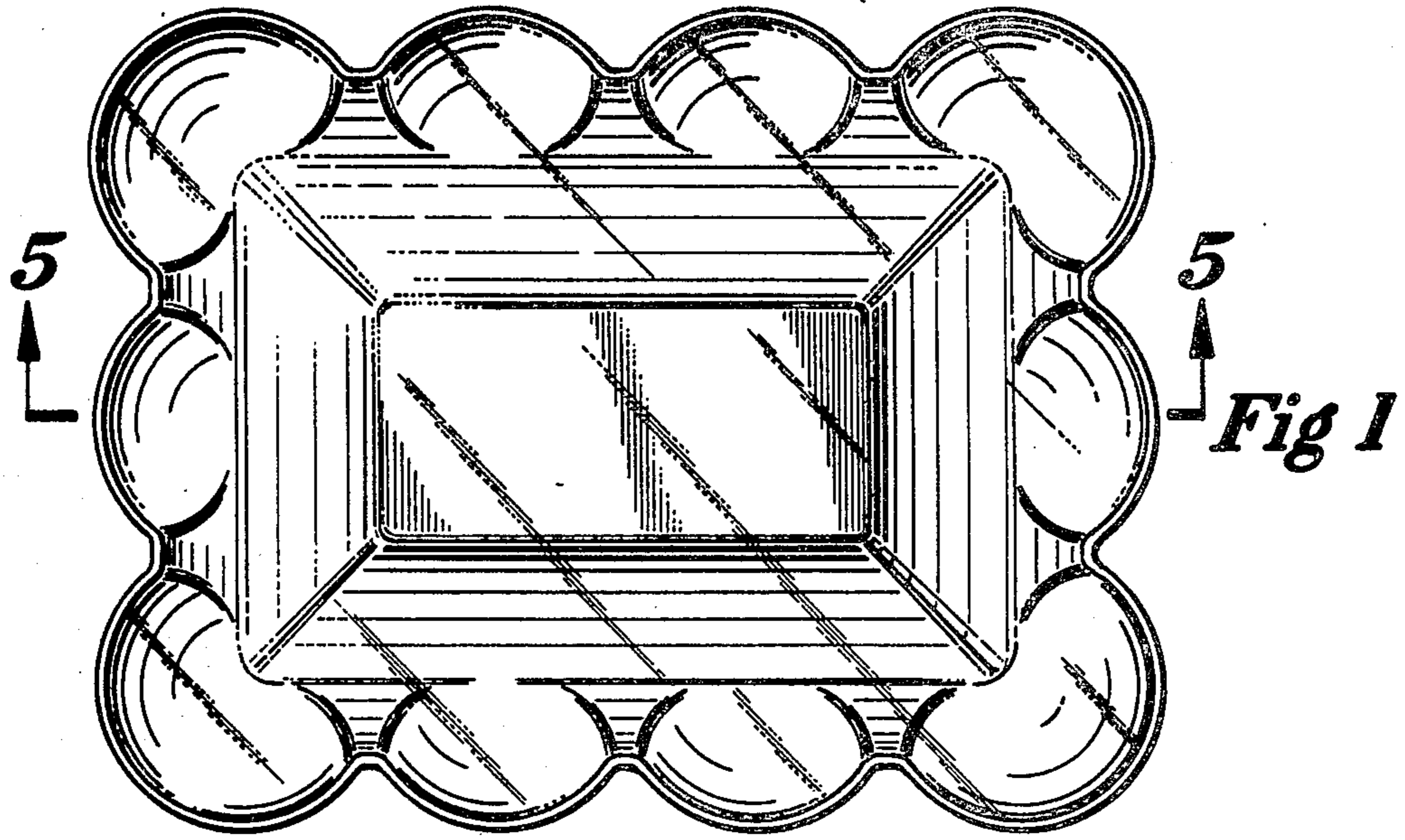

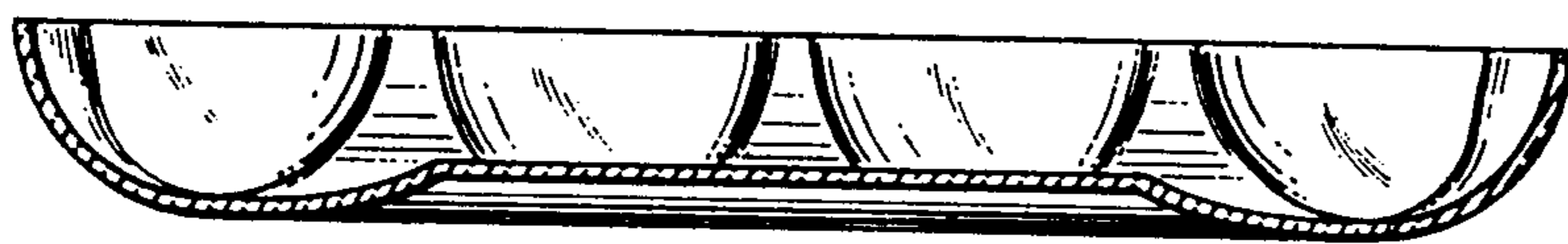

Fig 5



Fig 6