

[54] PEDESTAL BASED ARM CHAIR

[75] Inventor: Robert A. Keeler, Grand Rapids, Mich.

[73] Assignee: Steelcase, Inc., Grand Rapids, Mich.

[\*\*] Term: 14 Years

[21] Appl. No.: 328,459

[22] Filed: Dec. 7, 1981

[52] U.S. Cl. .... D6/31

[58] Field of Search ..... D6/30, 31, 26

[56] References Cited

U.S. PATENT DOCUMENTS

- D. 240,374 7/1976 Buhk ..... D6/31
- D. 250,374 11/1978 Prizlow et al. .... D6/31
- D. 267,838 2/1983 Buhk et al. .... D6/31

OTHER PUBLICATIONS

- Interiors*, Feb. 1978, p. 50, chair by Stow/Davis.
- Interiors*, Sep., 1980, p. 80, Harter Design.
- Interiors*, Feb., 1976, p. 25, Stendig Design.
- Interiors*, May, 1978, p. 73, Thygesen Design.

Primary Examiner—Bruce W. Dunkins

Attorney, Agent, or Firm—Price, Heneveld, Huizenga & Cooper

[57] CLAIM

The ornamental design for the pedestal based arm chair, as shown and described.

DESCRIPTION

FIG. 1 is a perspective view of a pedestal based arm chair embodying my design, taken from a generally forward side thereof.

FIG. 2 is a side elevational view of the design, taken from the right hand side thereof, wherein the left hand side is substantially identical.

FIG. 3 is a front elevational view of the design.

FIG. 4 is a slightly enlarged, bottom plan view of the design.

FIG. 5 is a slightly enlarged, top plan view of the design.

FIG. 6 is a slightly enlarged, fragmentary perspective view of an arm portion of the design.

FIG. 7 is a rear elevational view of the design.

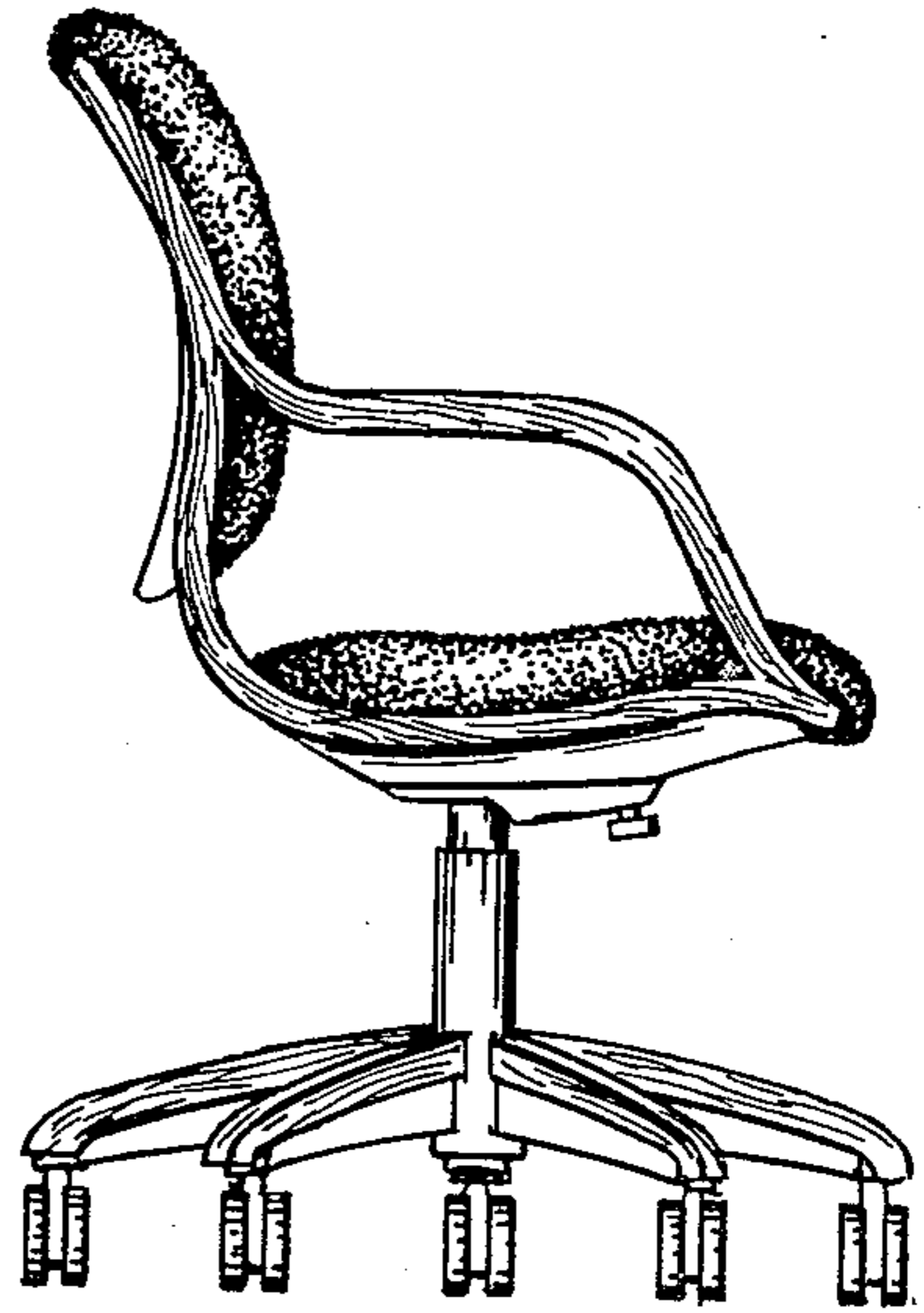
FIG. 8 is a perspective view of another embodiment of my design, having arm panels and armcaps.

FIG. 9 is a perspective view of yet another embodiment of my design, having armcaps.

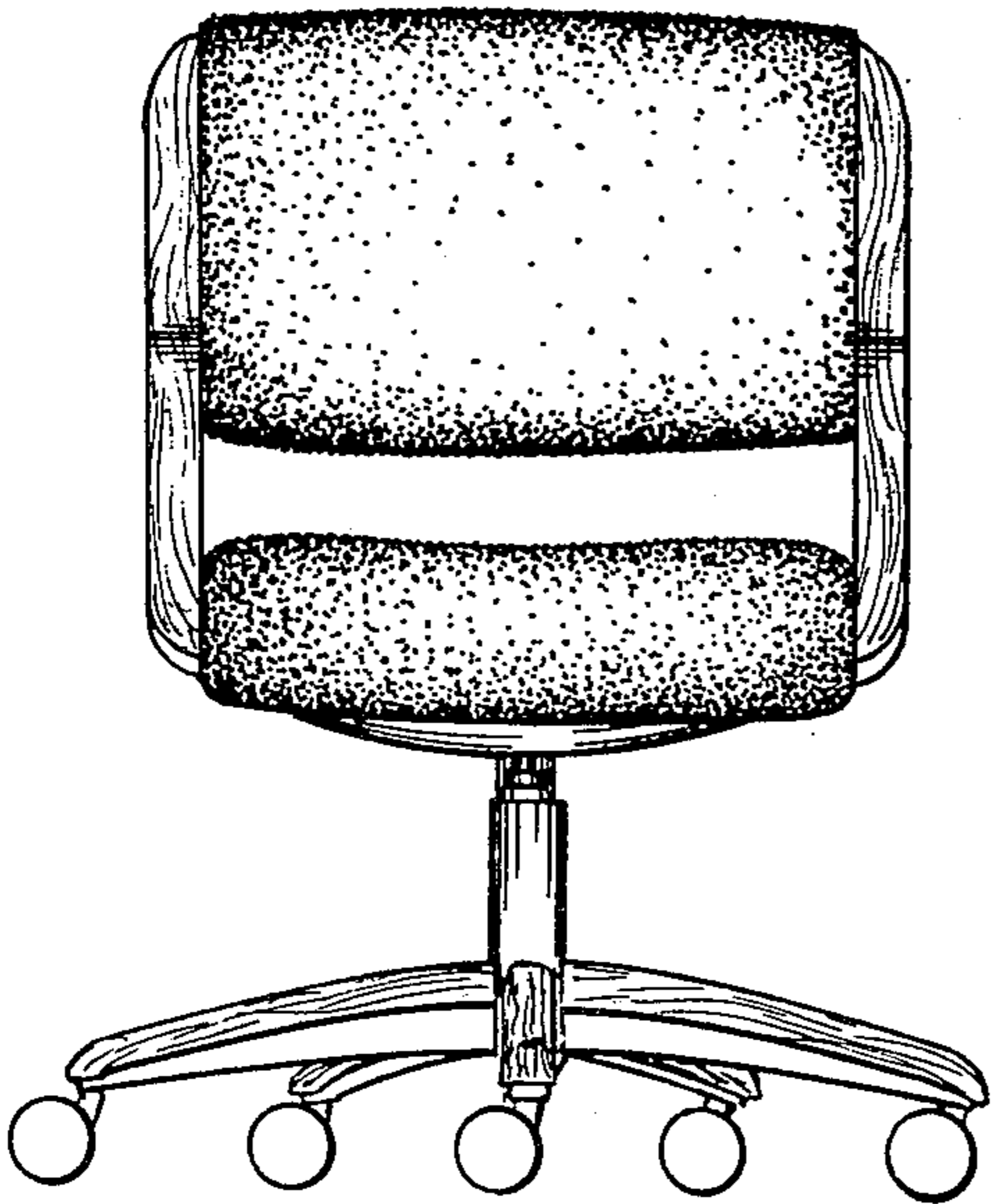




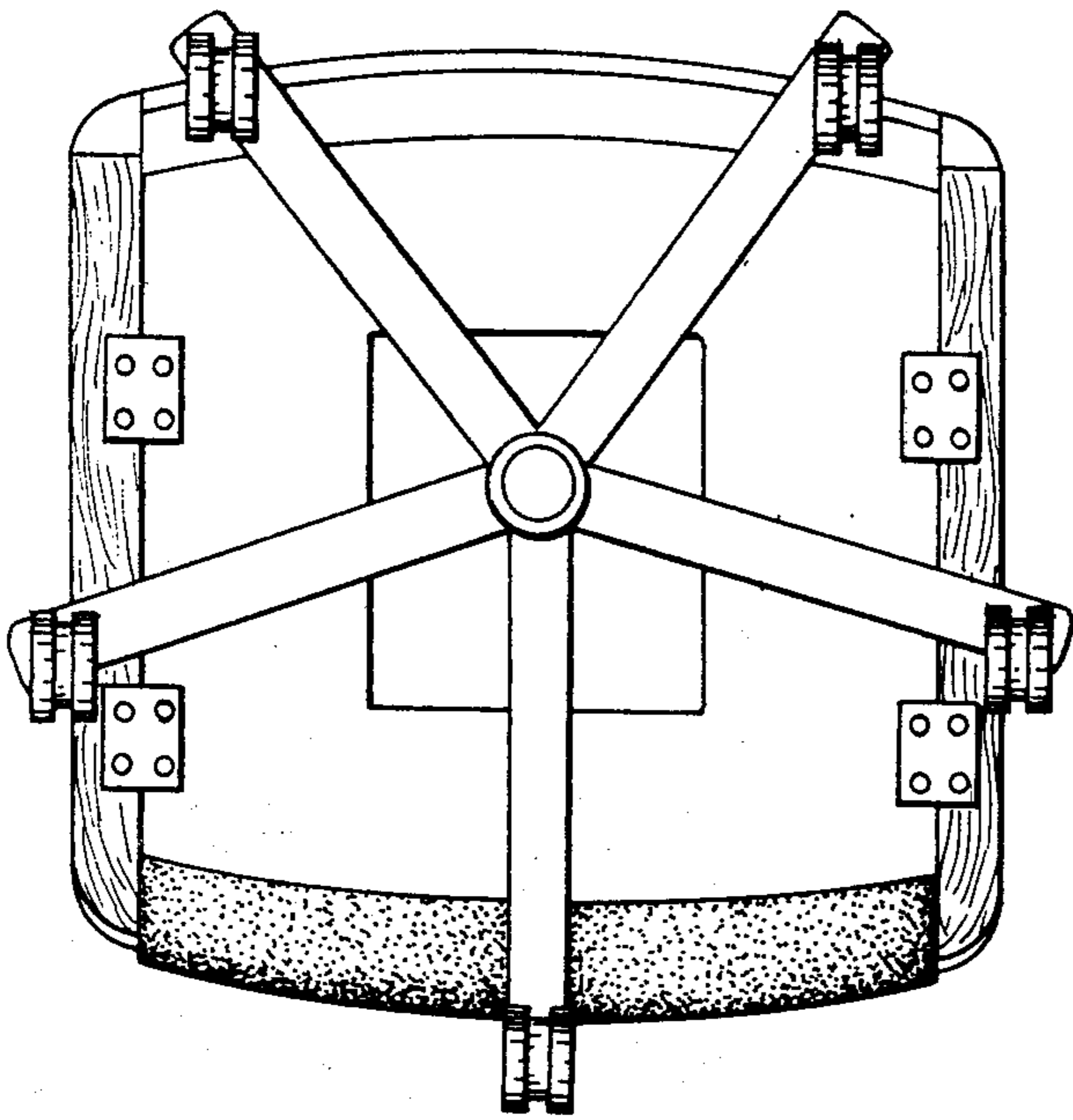
*Fig. 1.*



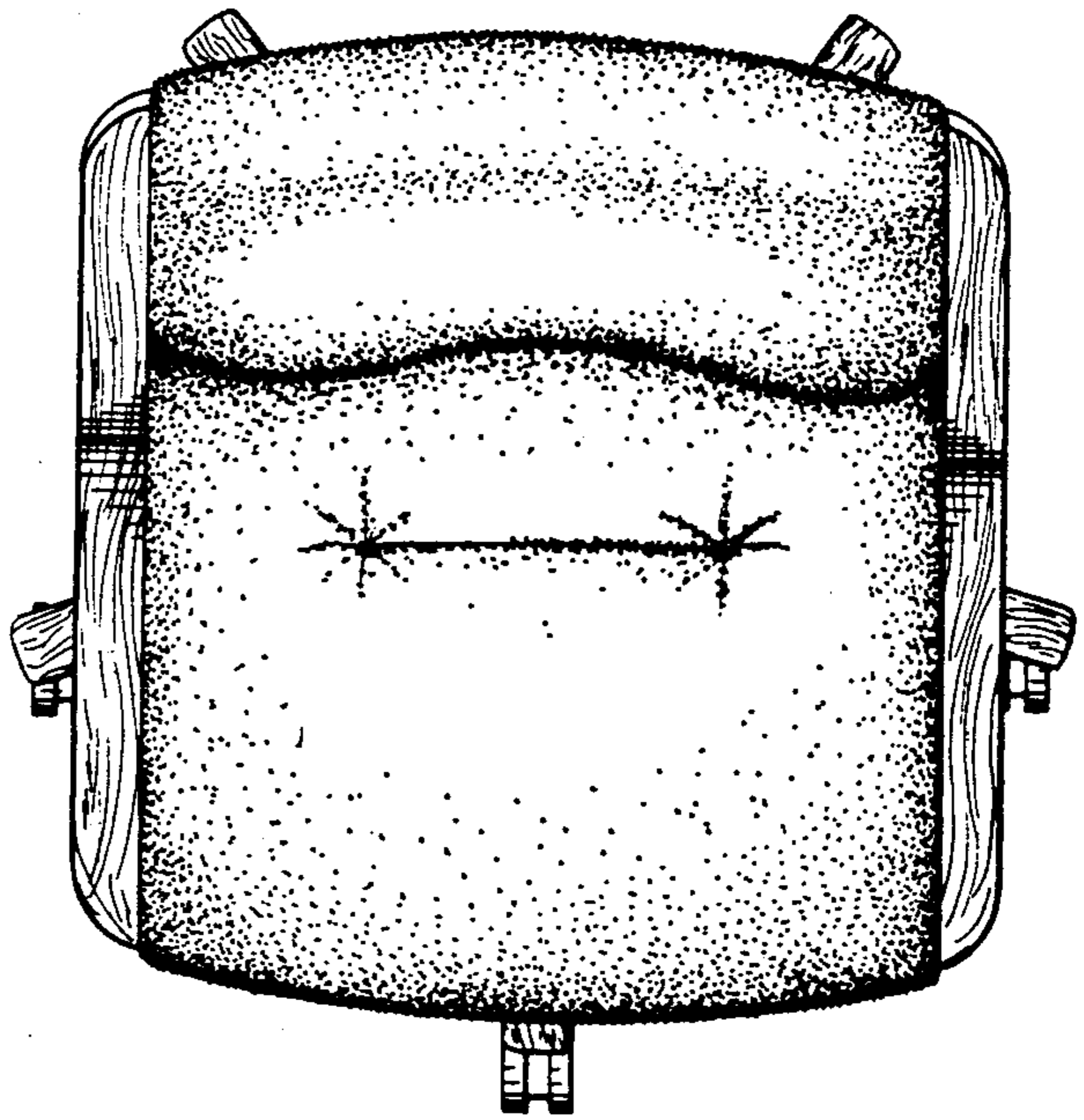
*Fig. 2*



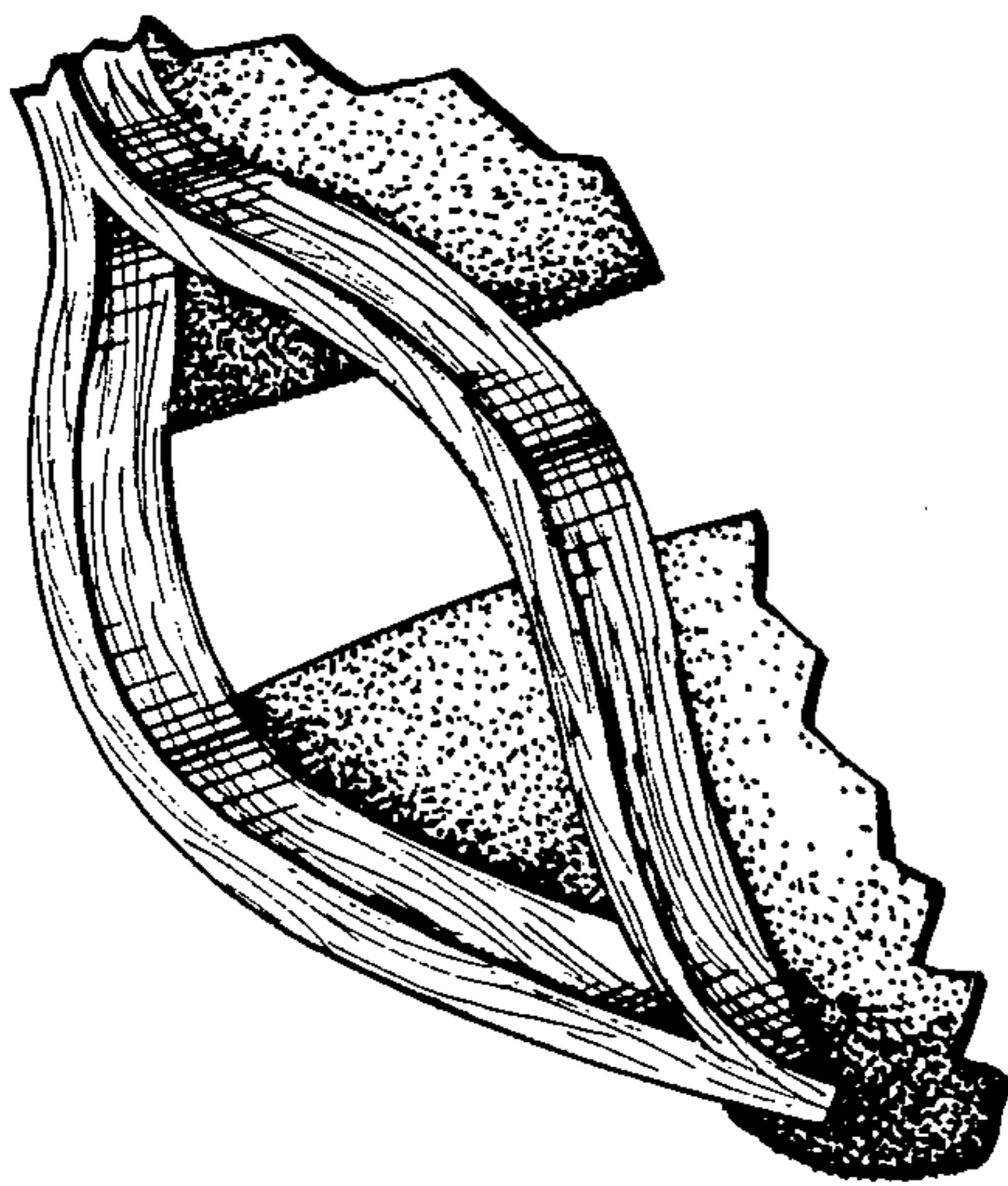
*Fig. 3.*



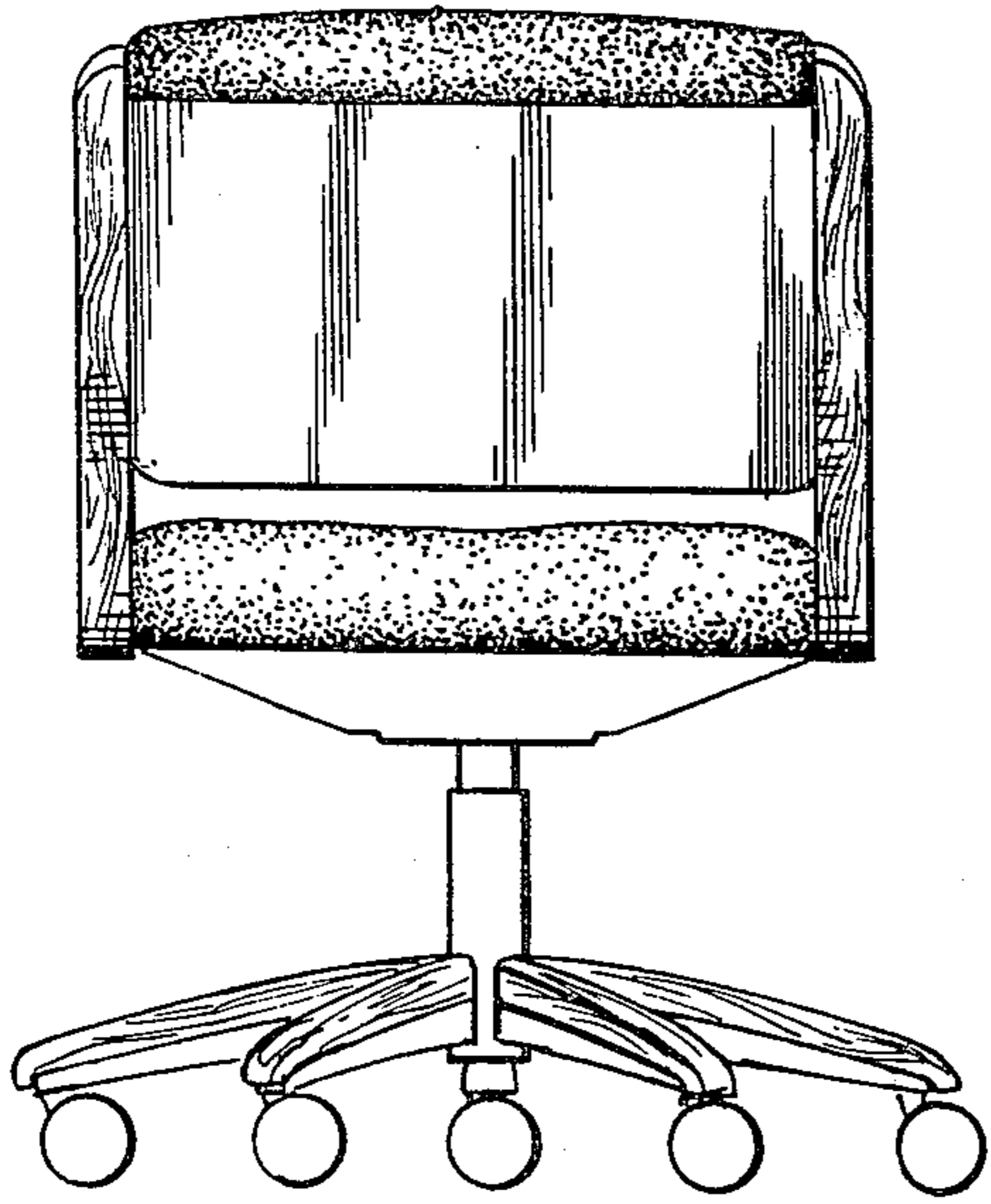
*Fig. 4.*



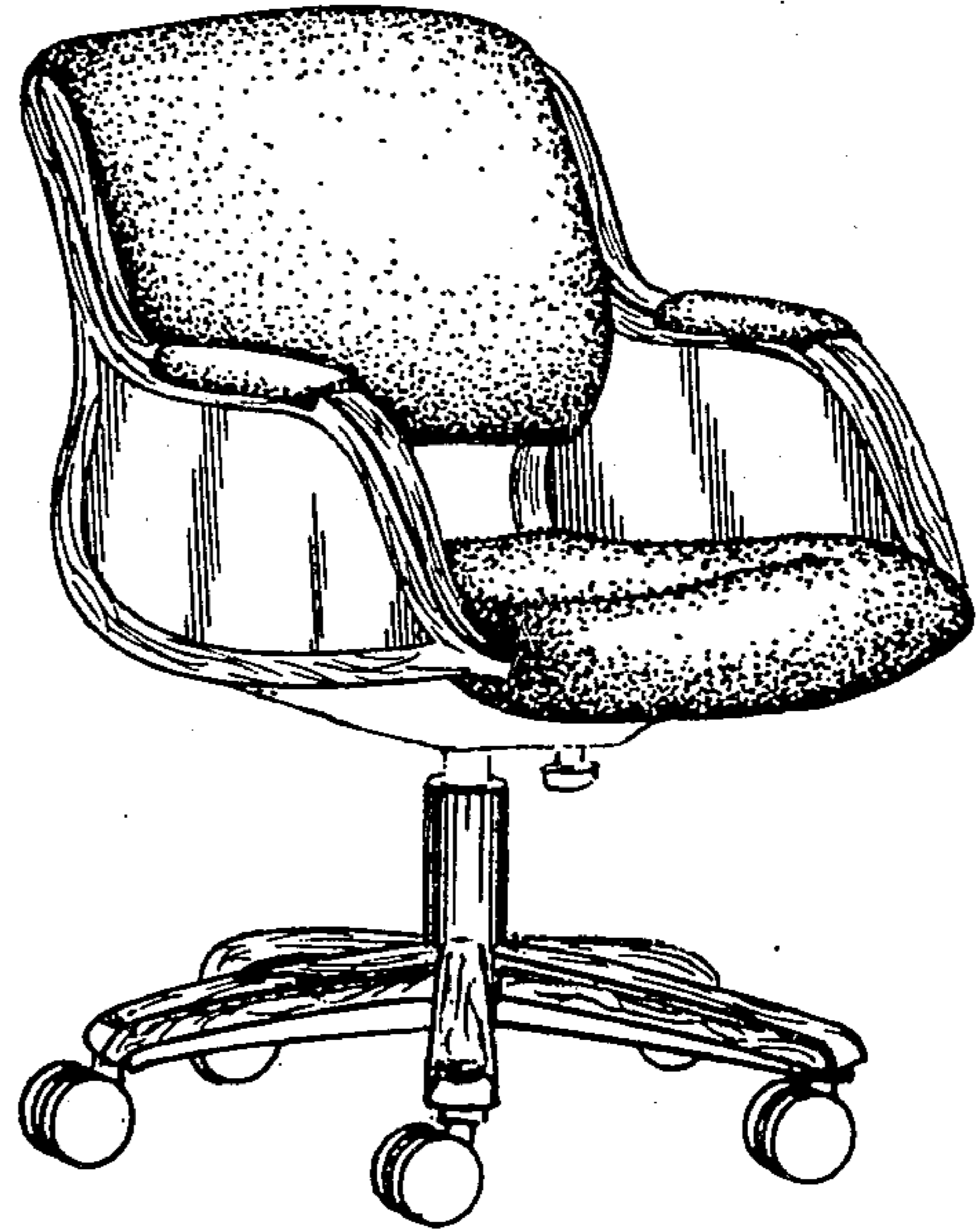
*Fig. 5.*



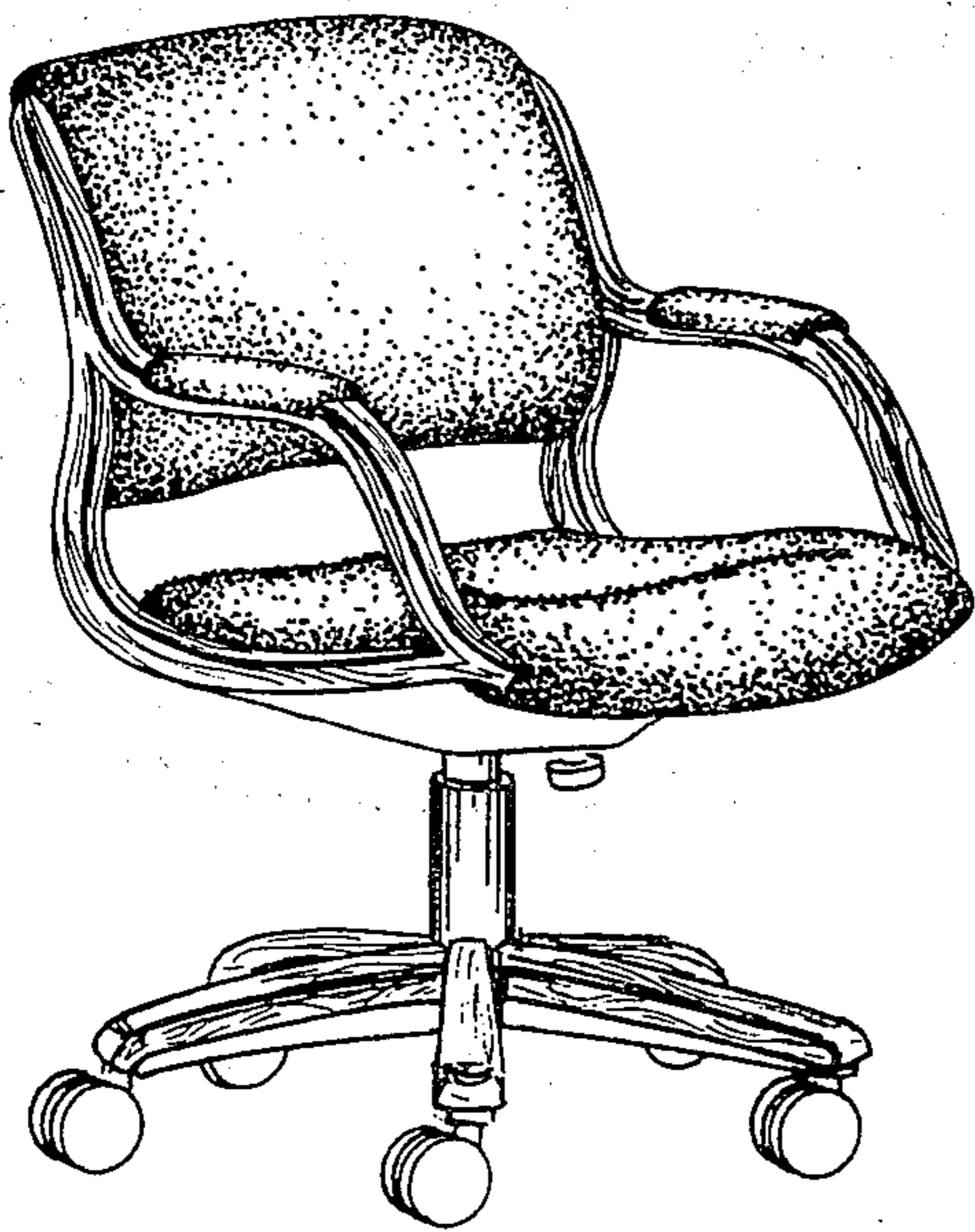
*Fig. 6.*



*Fig. 7.*



*Fig. 8.*



*Fig. 9.*