

[54] FISHING REEL

4,331,303 5/1982 Moss ..... 242/84.2 A

[75] Inventors: Robert W. Fee, Wichita; Richard J. Robbins, Derby, both of Kans.

Primary Examiner—A. Hugo Word  
Attorney, Agent, or Firm—John G. Heimovics

[73] Assignee: Brunswick Corporation, Skokie, Ill.

[57] CLAIM

[\*\*] Term: 14 Years

The ornamental design of a fishing reel, as shown and described.

[21] Appl. No.: 386,628

DESCRIPTION

[22] Filed: Jun. 10, 1982

[52] U.S. Cl. .... D22/25

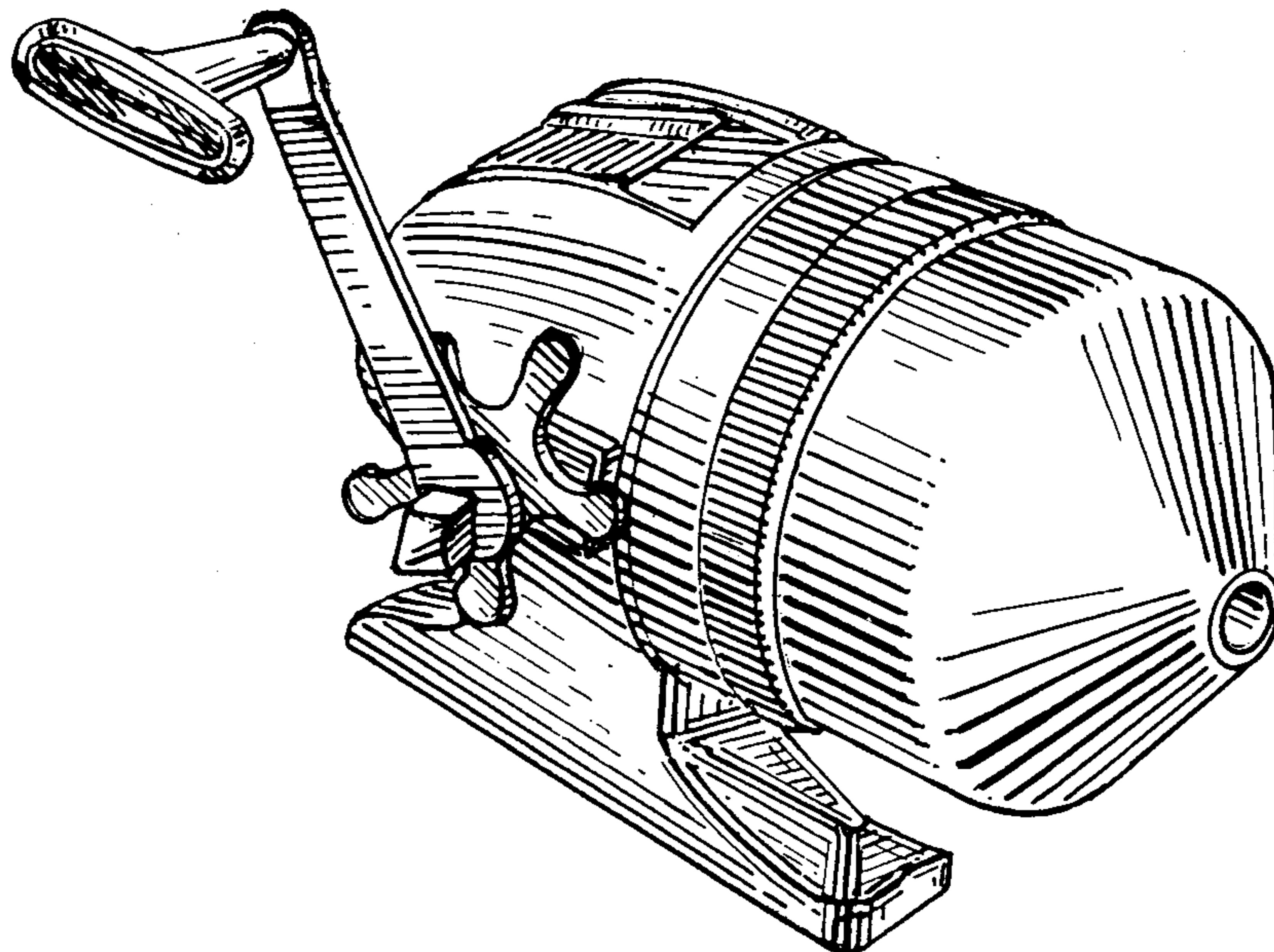
[58] Field of Search ..... 242/84.1 R, 84.2 R,  
242/84.2 A; D22/25, 26

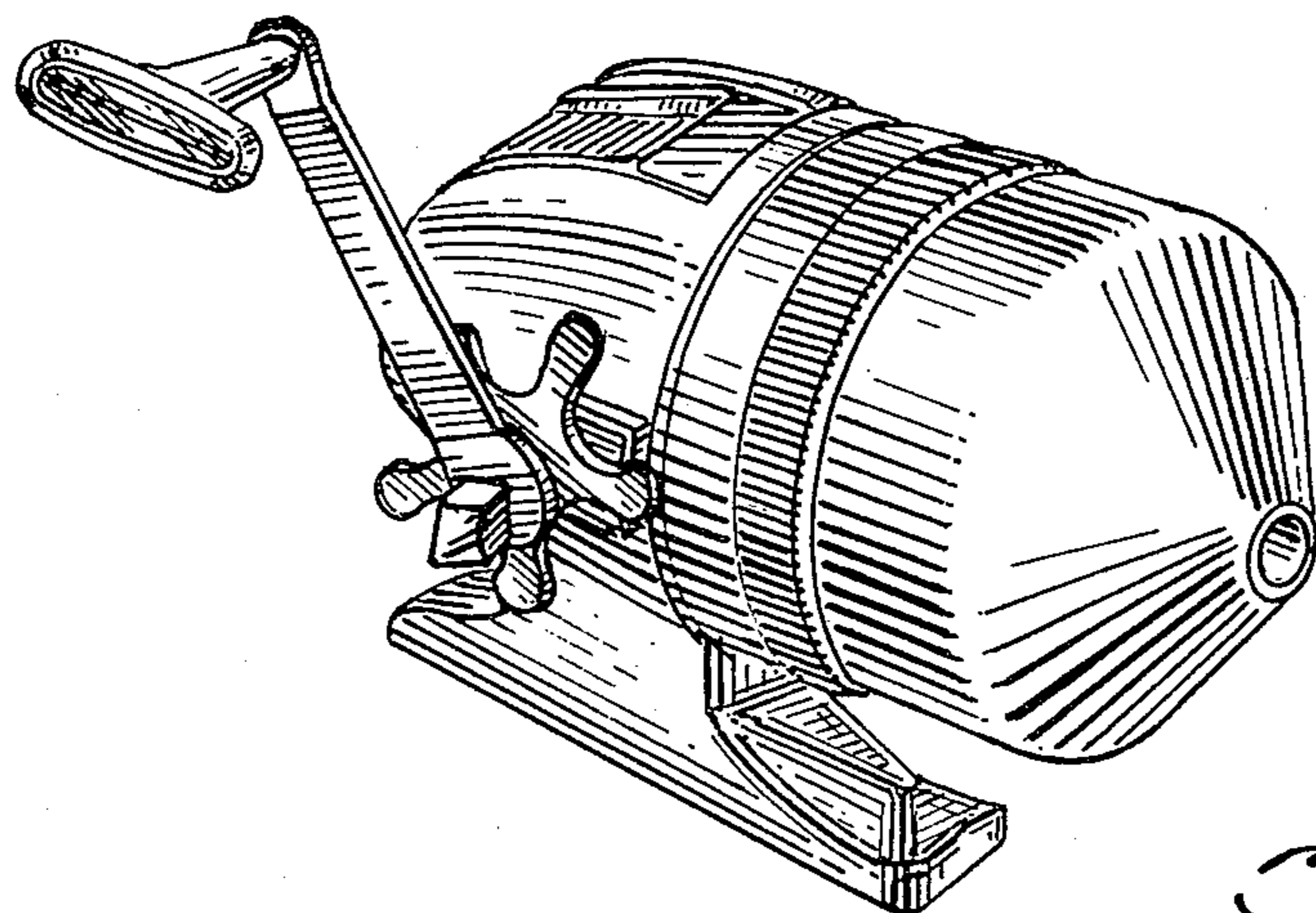
FIG. 1 is a perspective view of a front and side portion of the fishing reel showing our new design;  
FIG. 2 is a side elevation view thereof;  
FIG. 3 is a side elevation view opposite to the view shown in FIG. 2;  
FIG. 4 is a front elevation view thereof;  
FIG. 5 is a top plan view thereof;  
FIG. 6 is a bottom plan view thereof; and,  
FIG. 7 is a back elevation view.

[56] References Cited

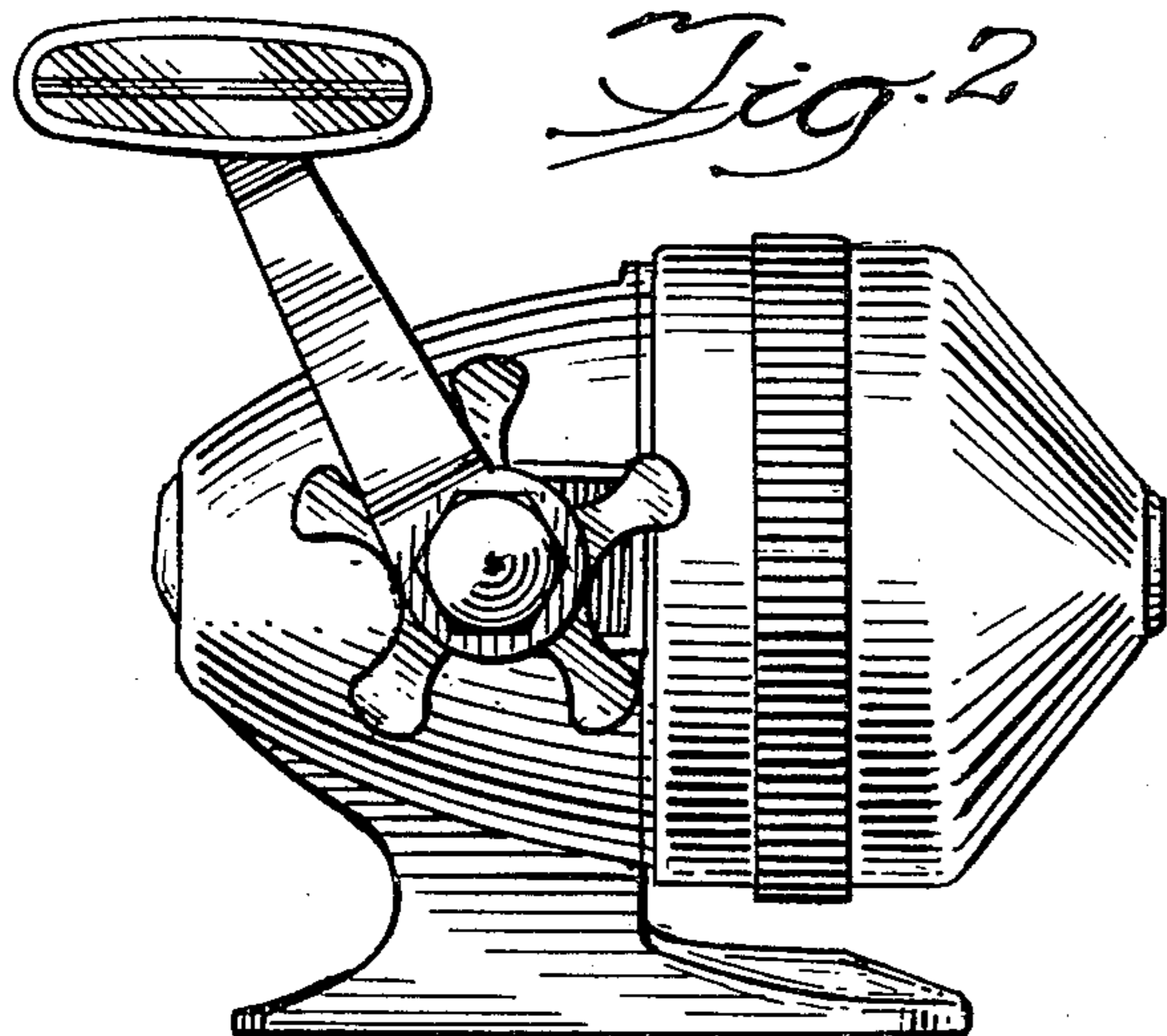
U.S. PATENT DOCUMENTS

- D. 226,850 5/1973 Hull ..... D22/25
- 3,794,264 2/1974 Hull ..... 242/84.2 R

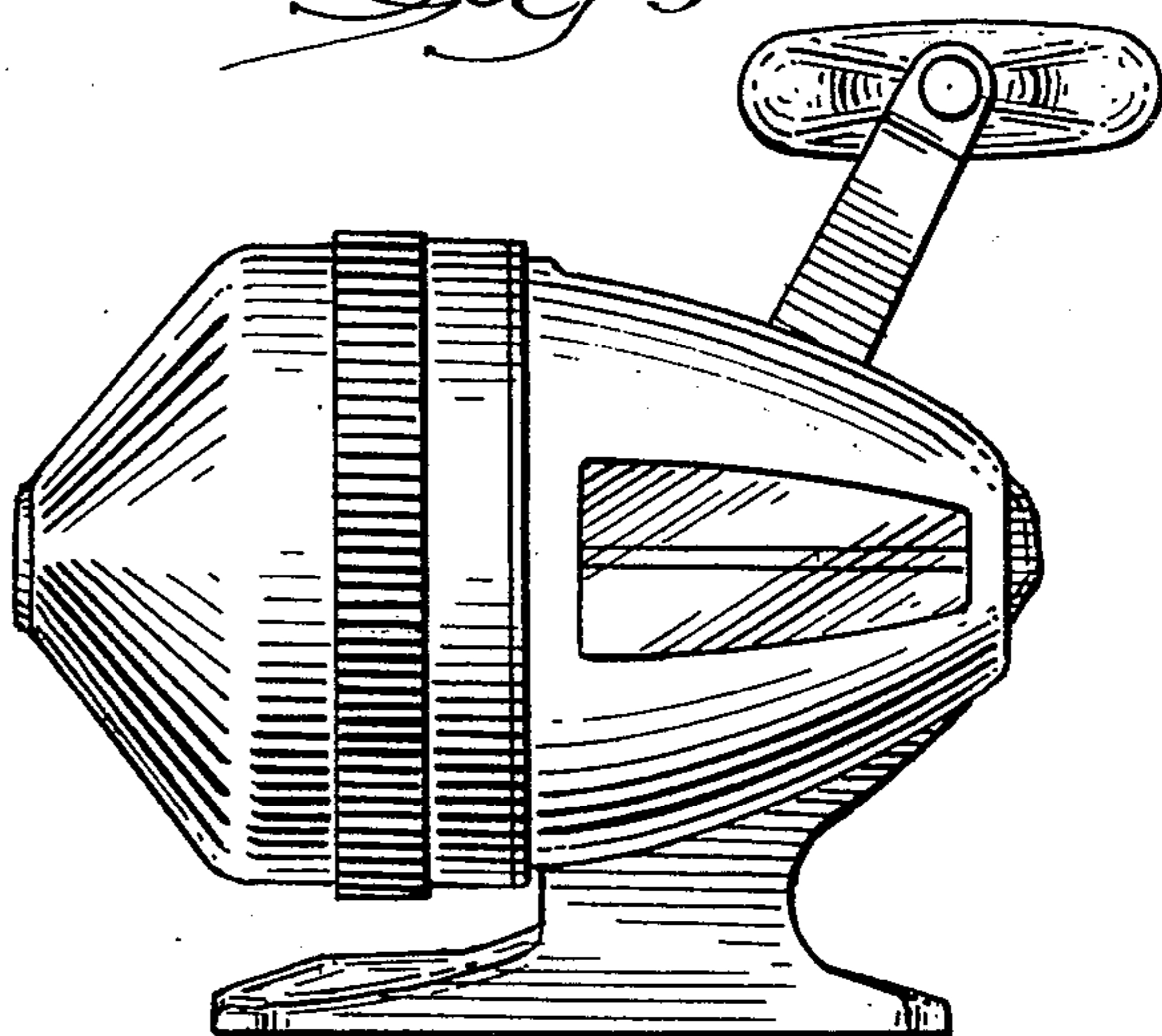




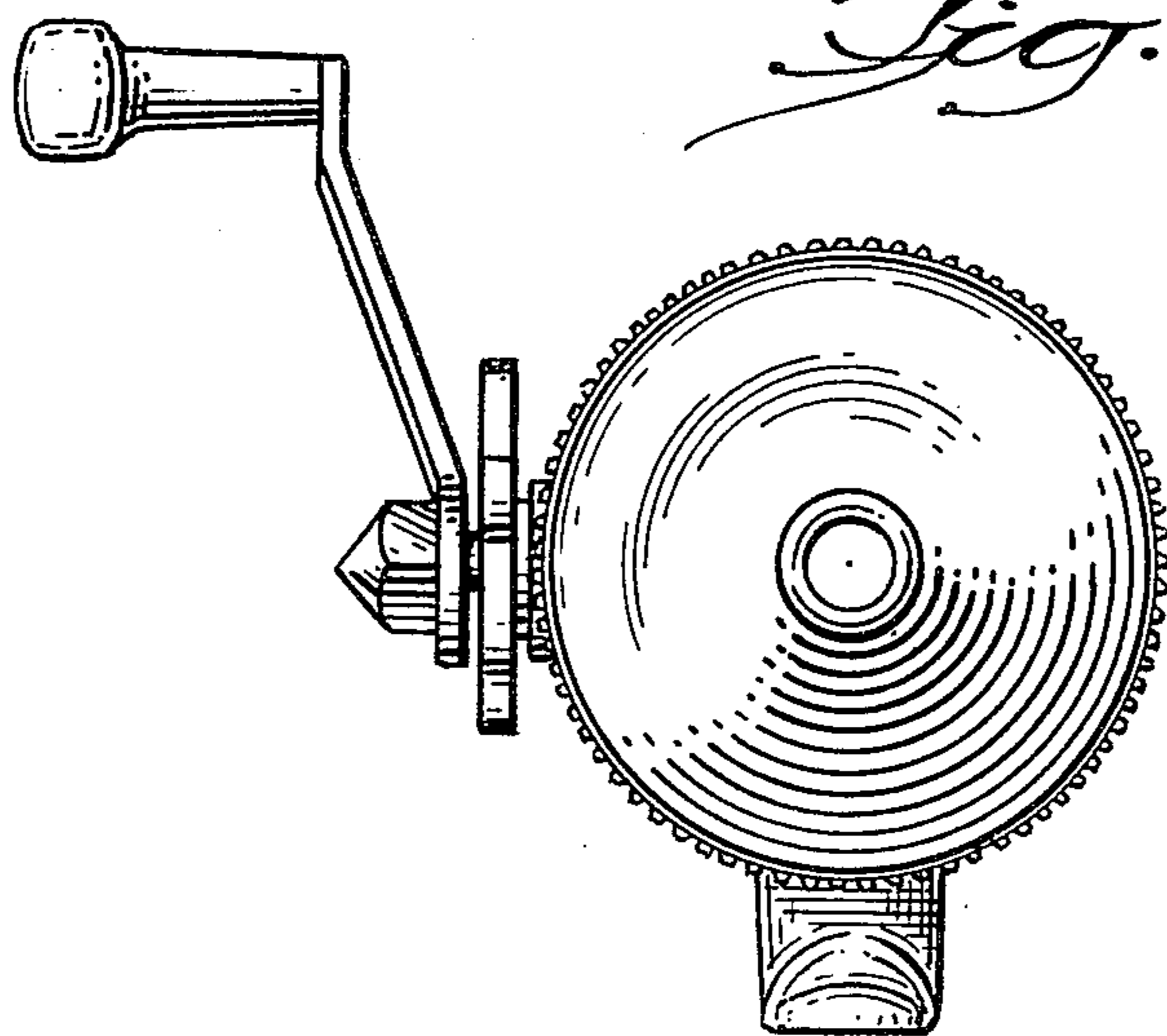
*Fig. 1*



*Fig. 2*

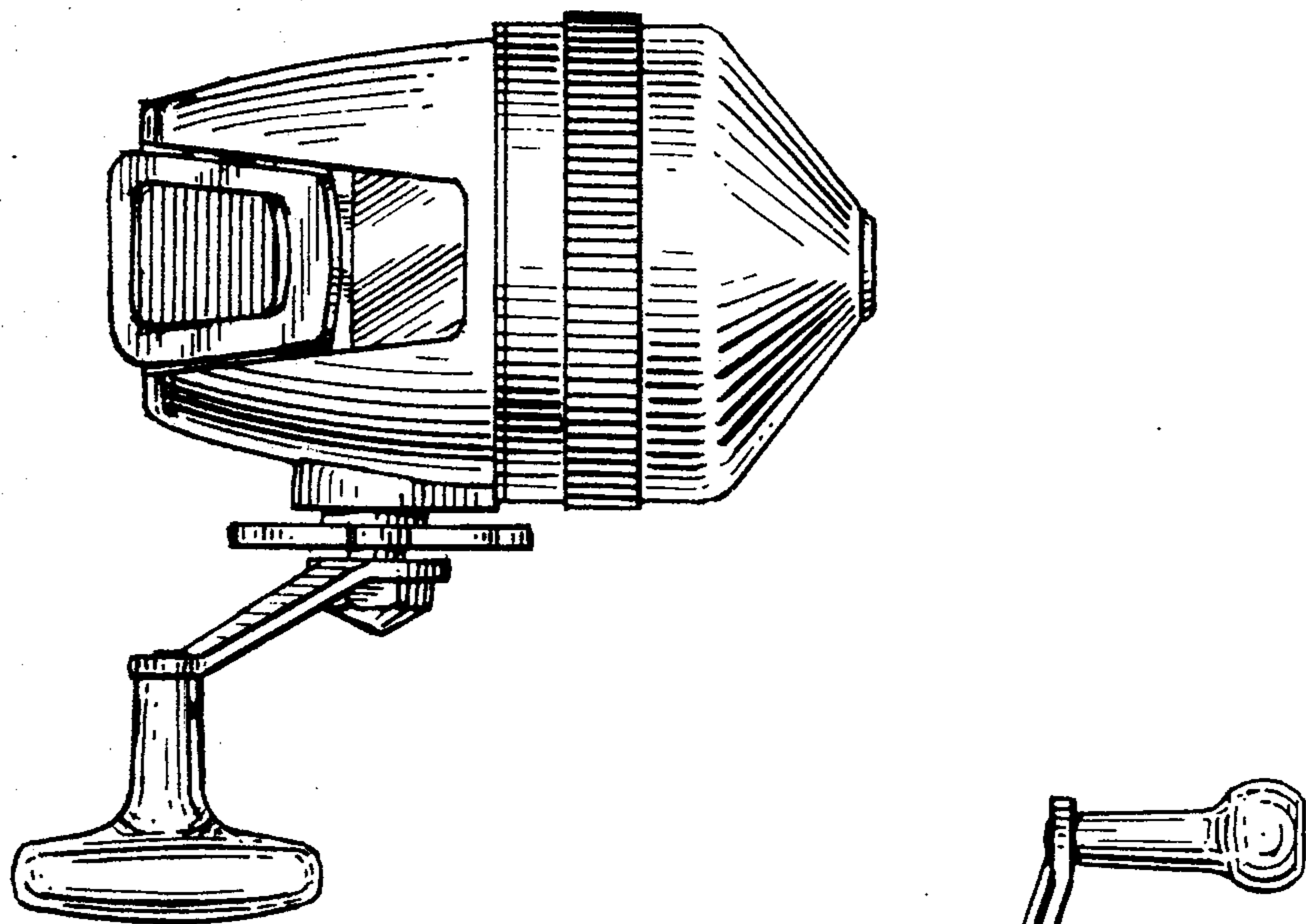


*Fig. 3*

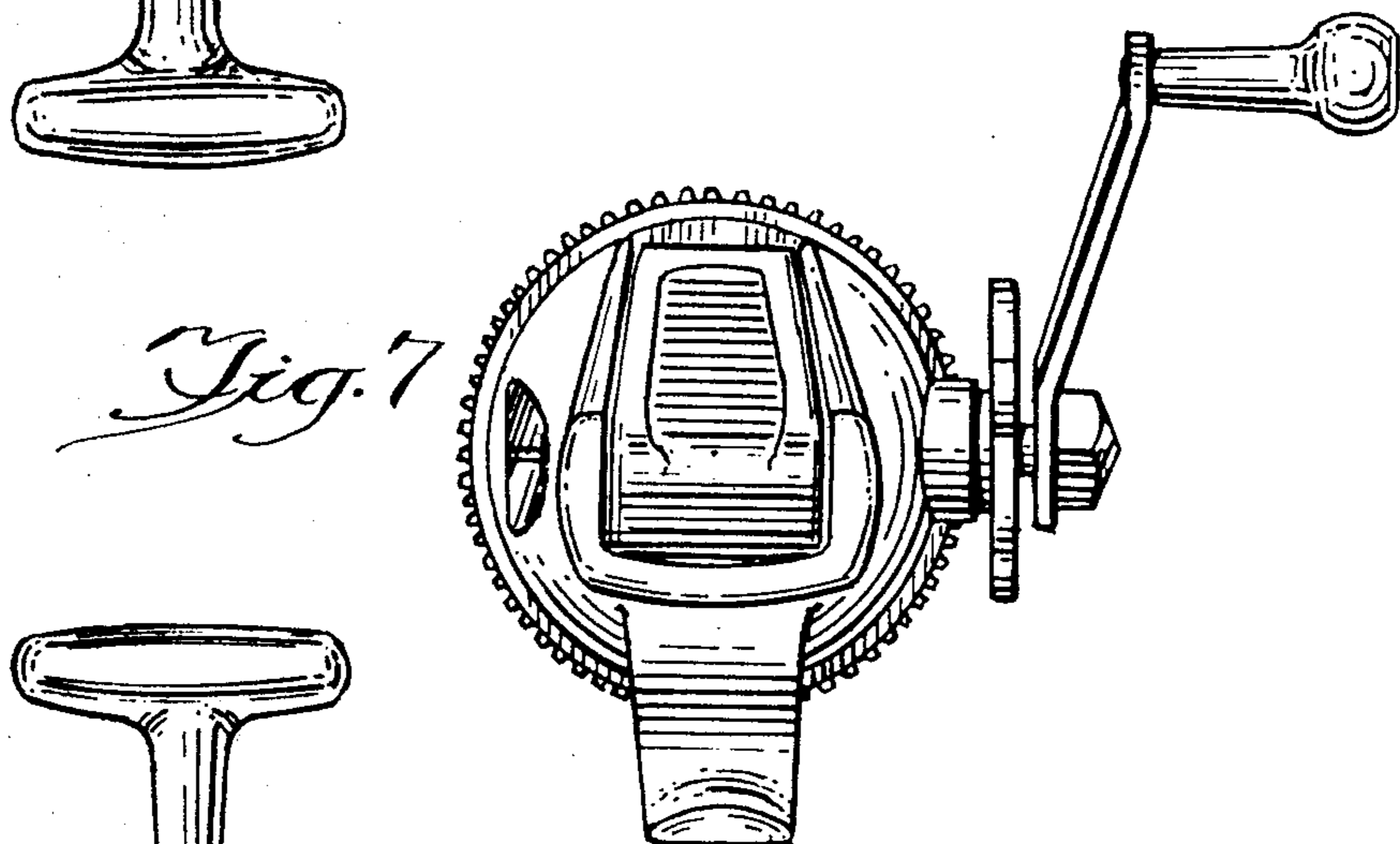


*Fig. 4*

*Fig. 5*



*Fig. 7*



*Fig. 6*

