

[54] COMBINED HANGING DISPLAY CASE AND CLOCK

[75] Inventor: James B. Bowers, Tulsa, Okla.

[73] Assignee: H and H Promotions, Inc., Tulsa, Okla.

[**] Term: 14 Years

[21] Appl. No.: 336,083

[22] Filed: Dec. 31, 1981

[52] U.S. Cl. D6/172; D6/4; D6/114; D10/2

[58] Field of Search D6/4, 114, 127, 130, D6/172, 173; D10/2, 3, 24

[56] References Cited

U.S. PATENT DOCUMENTS

- D. 40,190 7/1909 Cohn D6/172
- D. 197,498 2/1964 Jones D6/172

- D. 216,406 12/1969 Hames D10/24
- D. 238,054 12/1975 Funahashi D10/24
- D. 248,626 7/1978 Lucich D10/2
- D. 258,820 4/1981 Hamada D10/2 X

Primary Examiner—Bruce W. Dunkins
Attorney, Agent, or Firm—Head, Johnson & Stevenson

[57] CLAIM

The ornamental design for a combined hanging display case and clock, substantially as shown and described.

DESCRIPTION

- FIG. 1 is a prospective view of a combined hanging display case and clock showing my new design.
- FIG. 2 is a front elevational view, the opposite back view being a mirror image thereof.
- FIG. 3 is a top plan view.
- FIG. 4 is a right side elevational view.
- FIG. 5 is a left side elevational view.
- FIG. 6 is a bottom plan view.

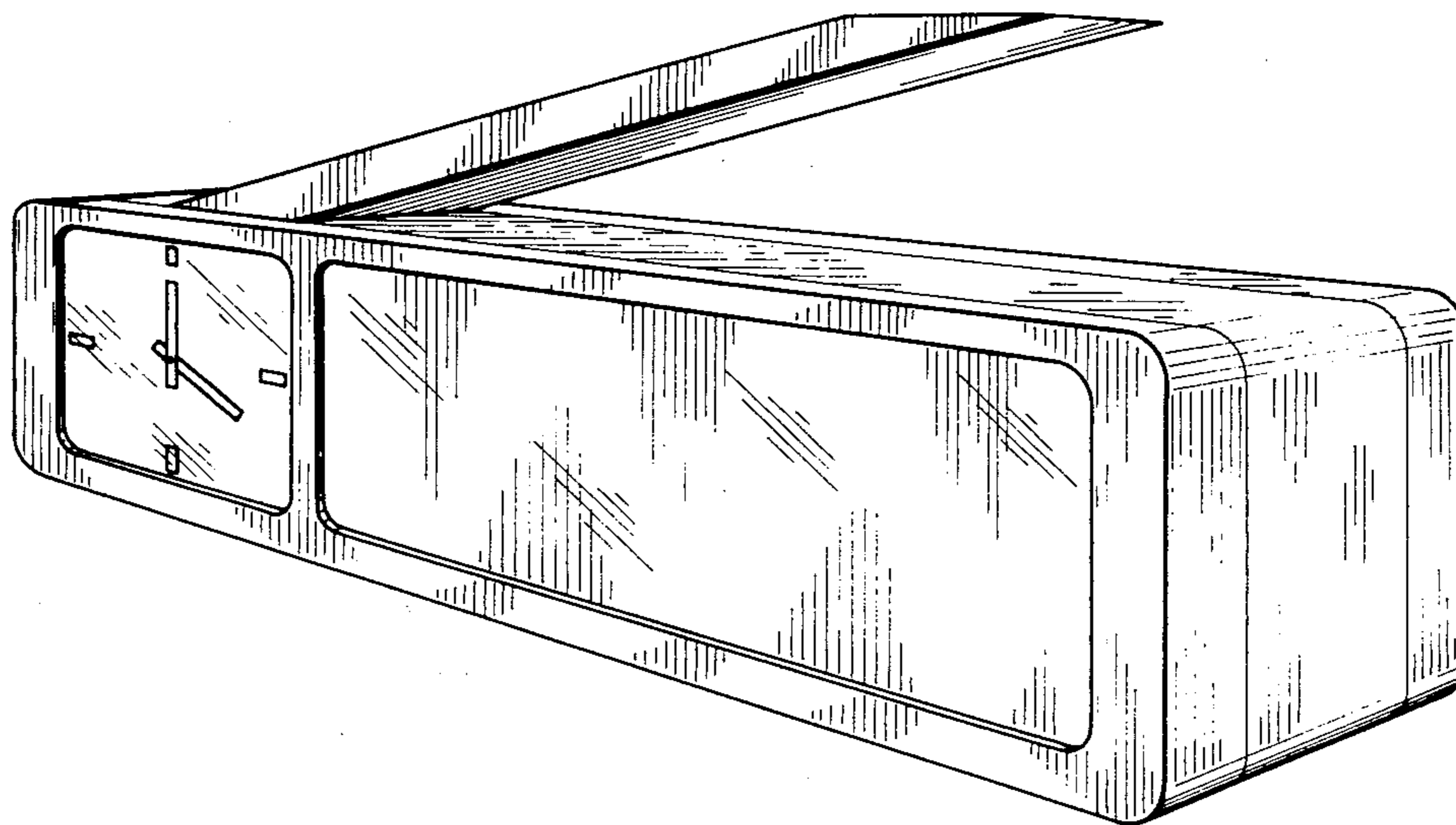

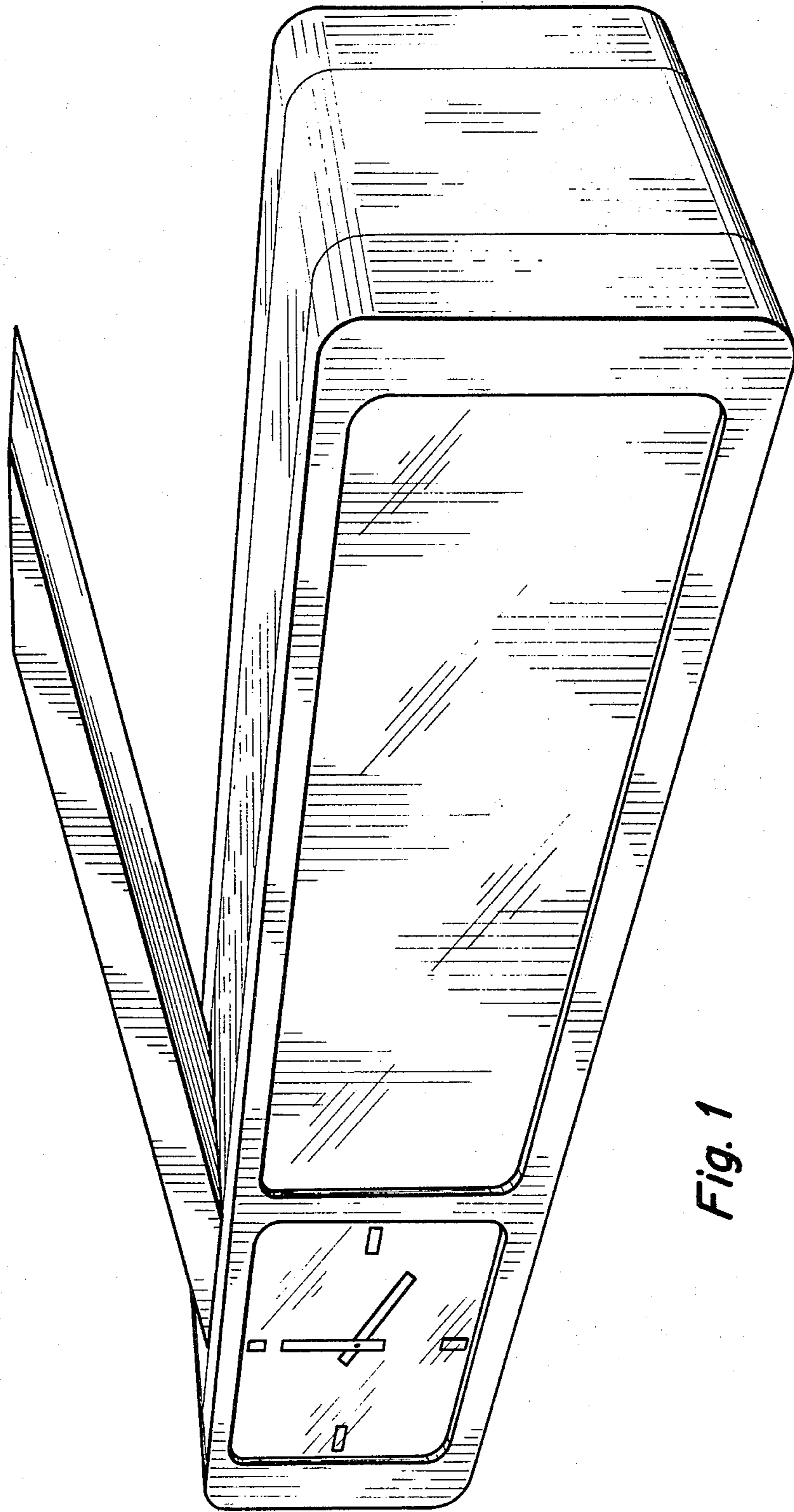

Fig. 1

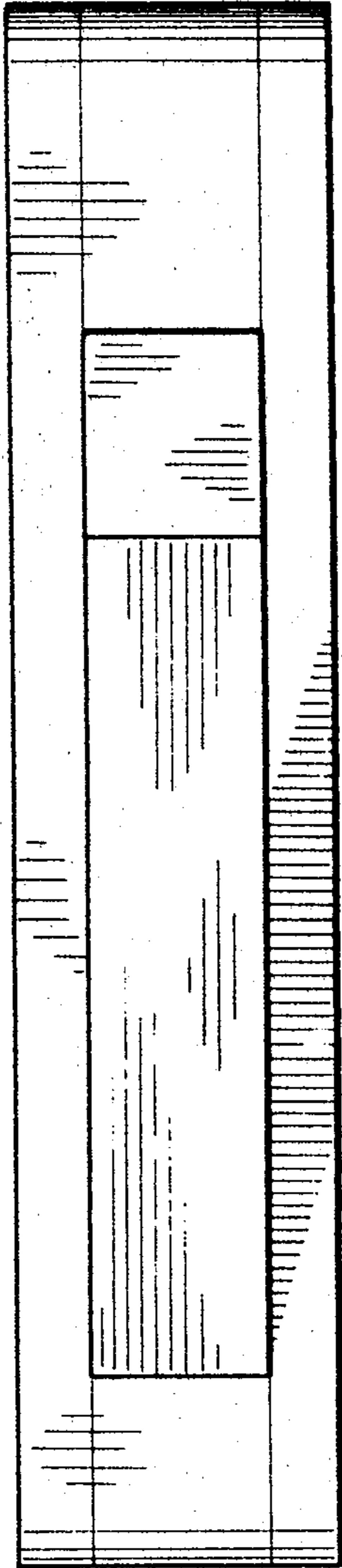

Fig. 3

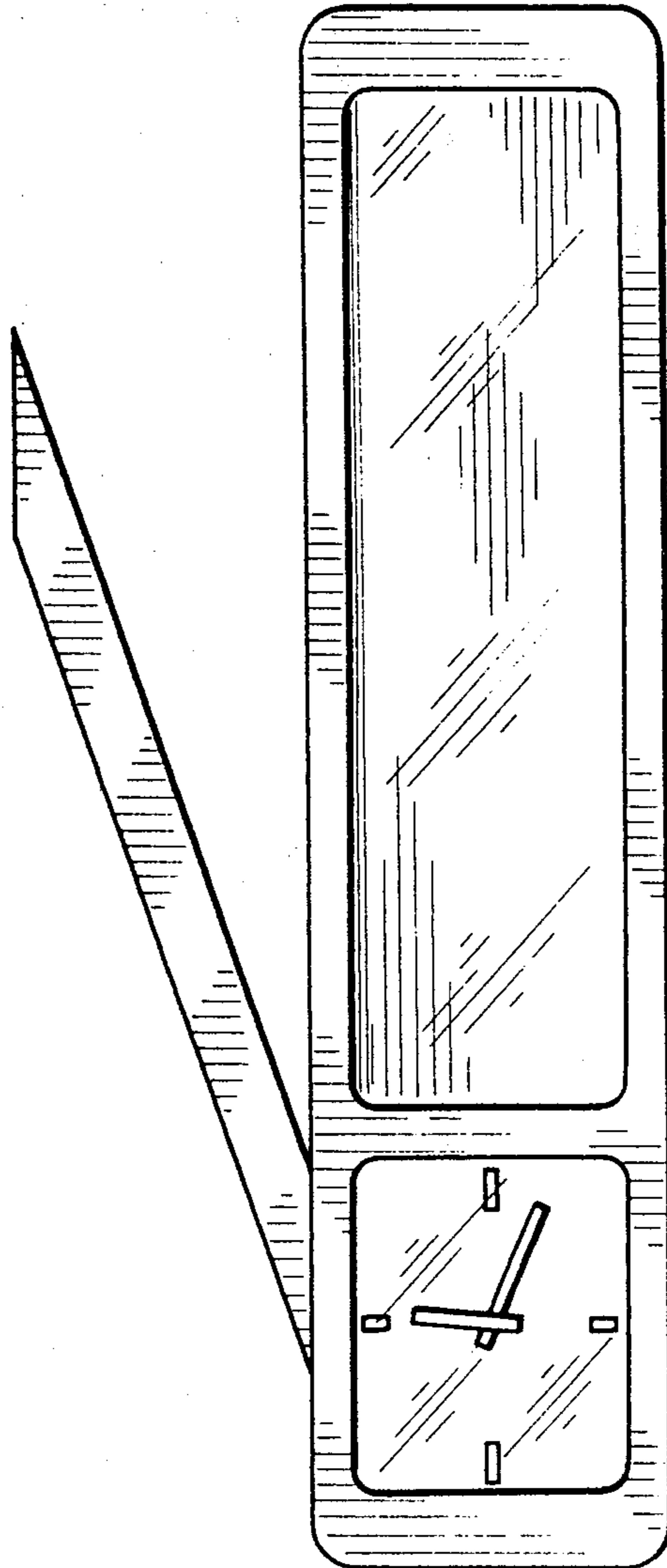

Fig. 2

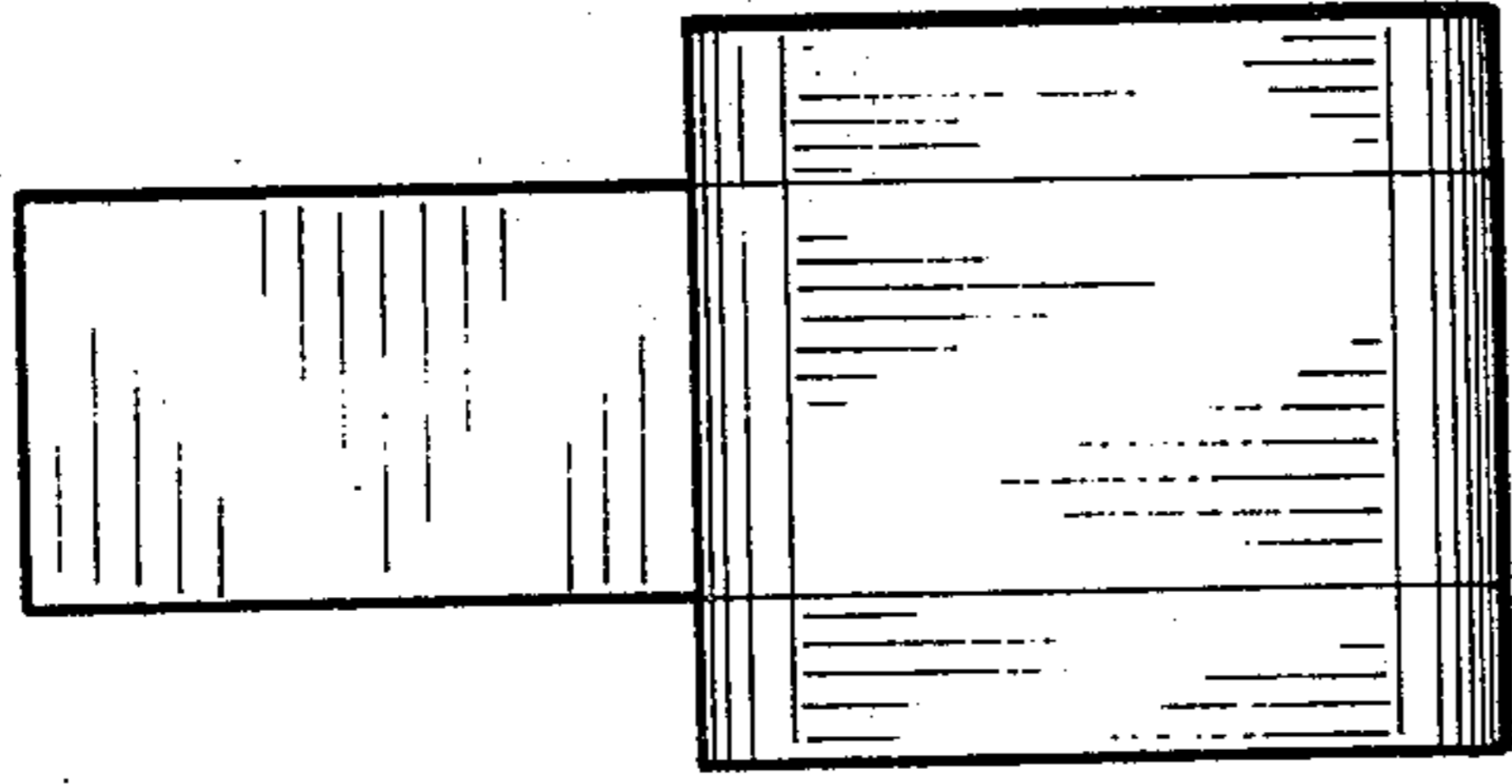

Fig. 5

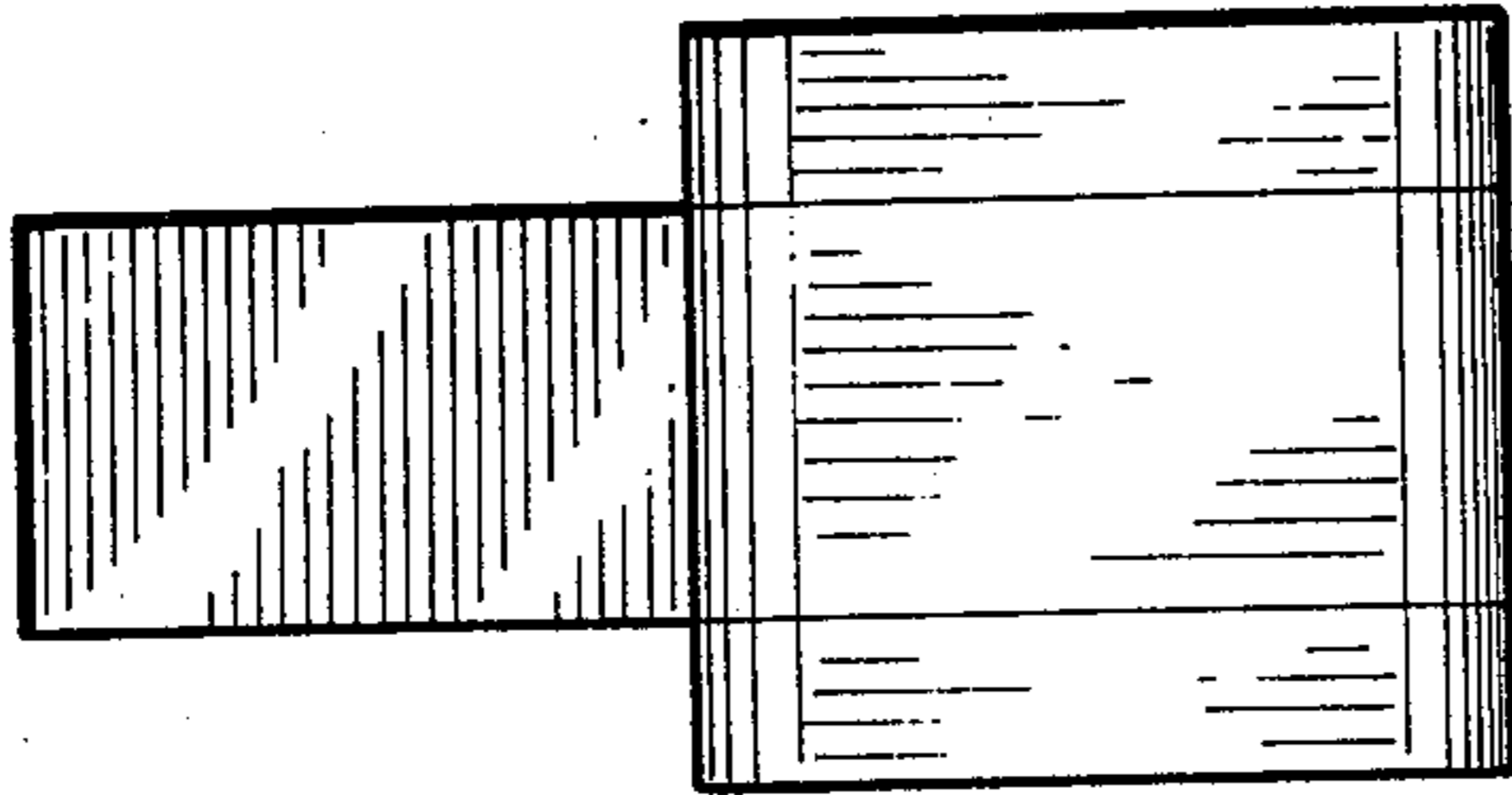

Fig. 4

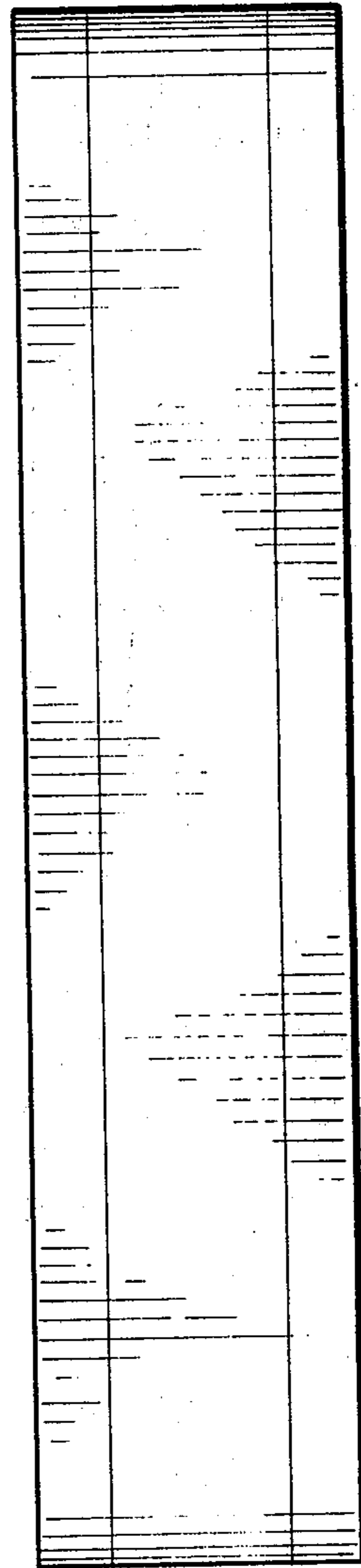

Fig. 6