

- [54] SOLENOID OPERATED VALVE
- [75] Inventors: **Ronald L. Loup**, Clarkston; **Curtis H. Day**, Manchester, both of Mich.; **George L. Schick**, Easton, Conn.
- [73] Assignee: **Double A Products Company**, Manchester, Mich.
- [\*\*] Term: **14 Years**
- [21] Appl. No.: **244,888**
- [22] Filed: **Mar. 18, 1981**
- [52] U.S. Cl. .... **D23/19**
- [58] Field of Search ..... **D23/19-22;**  
137/625.65

[56] **References Cited**  
**U.S. PATENT DOCUMENTS**

D. 211,085	5/1968	Padula .....	D23/19
D. 223,095	3/1972	Allen .....	D23/19
2,983,285	5/1961	Gardner .....	137/625.65
3,441,056	4/1969	Cleland .....	137/625.65
3,459,225	8/1969	Smith .....	137/625.65
3,608,586	9/1971	Daggy, Jr. ....	137/625.65
3,701,366	10/1972	Tirelli et al. ....	137/625.65
3,717,179	2/1973	Clark .....	137/625.65
3,799,203	3/1974	Doutt .....	137/625.65
4,185,661	1/1980	Gill et al. ....	137/625.65
4,353,394	10/1982	Loup .....	137/625.65

*Primary Examiner*—James R. Largen  
*Attorney, Agent, or Firm*—Stephenson & Boller

[57] **CLAIM**

The ornamental design for a solenoid operated valve, substantially as shown and described.

**DESCRIPTION**

FIG. 1 is a top plan view of a solenoid operated valve showing our new design;  
 FIG. 2 is a front elevational view thereof;  
 FIG. 3 is a bottom plan view thereof;  
 FIG. 4 is a rear elevational view thereof;  
 FIG. 5 is an elevational view taken from one end thereof;  
 FIG. 6 is an elevational view taken from the end opposite that shown in FIG. 5.  
 FIG. 7 is a perspective view taken from the top, front and one end thereon;  
 FIG. 8 is a top plan view of a modified form of the solenoid operated valve shown in FIG. 1;  
 FIG. 9 is a front elevational view of FIG. 8;  
 FIG. 10 is a bottom plan view of FIG. 8;  
 FIG. 11 is a rear elevational view of FIG. 8;  
 FIG. 12 is an elevational view taken from one end of FIG. 8; and  
 FIG. 13 is an elevational view taken from one end of FIG. 8.

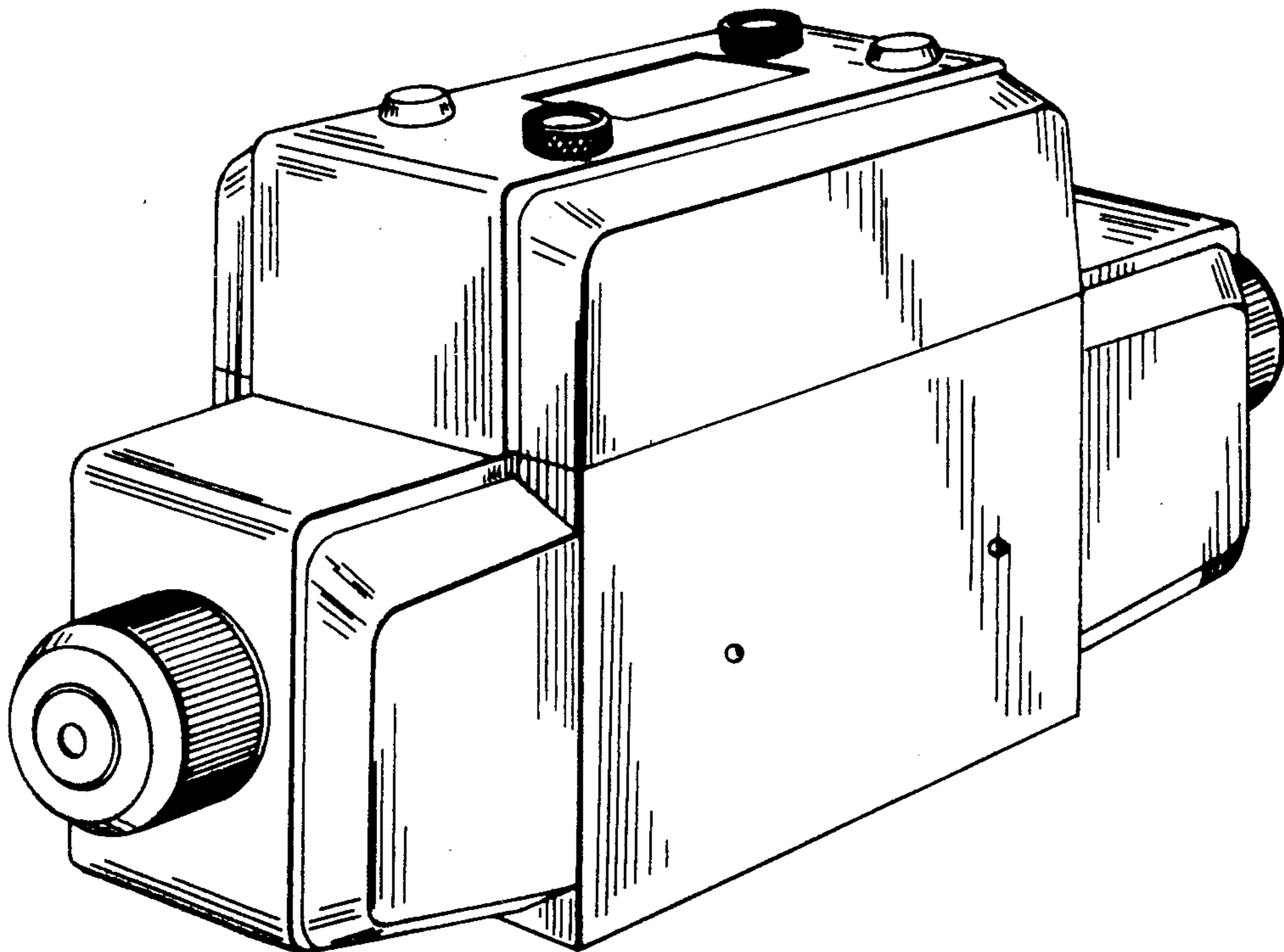

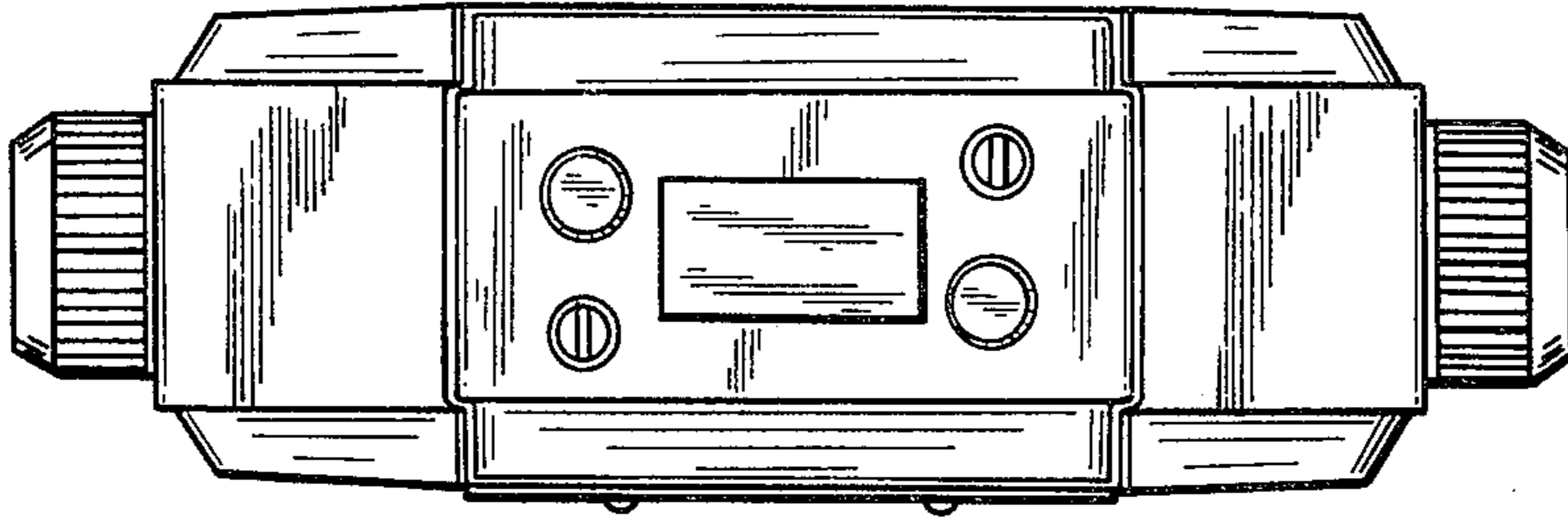

Fig-1

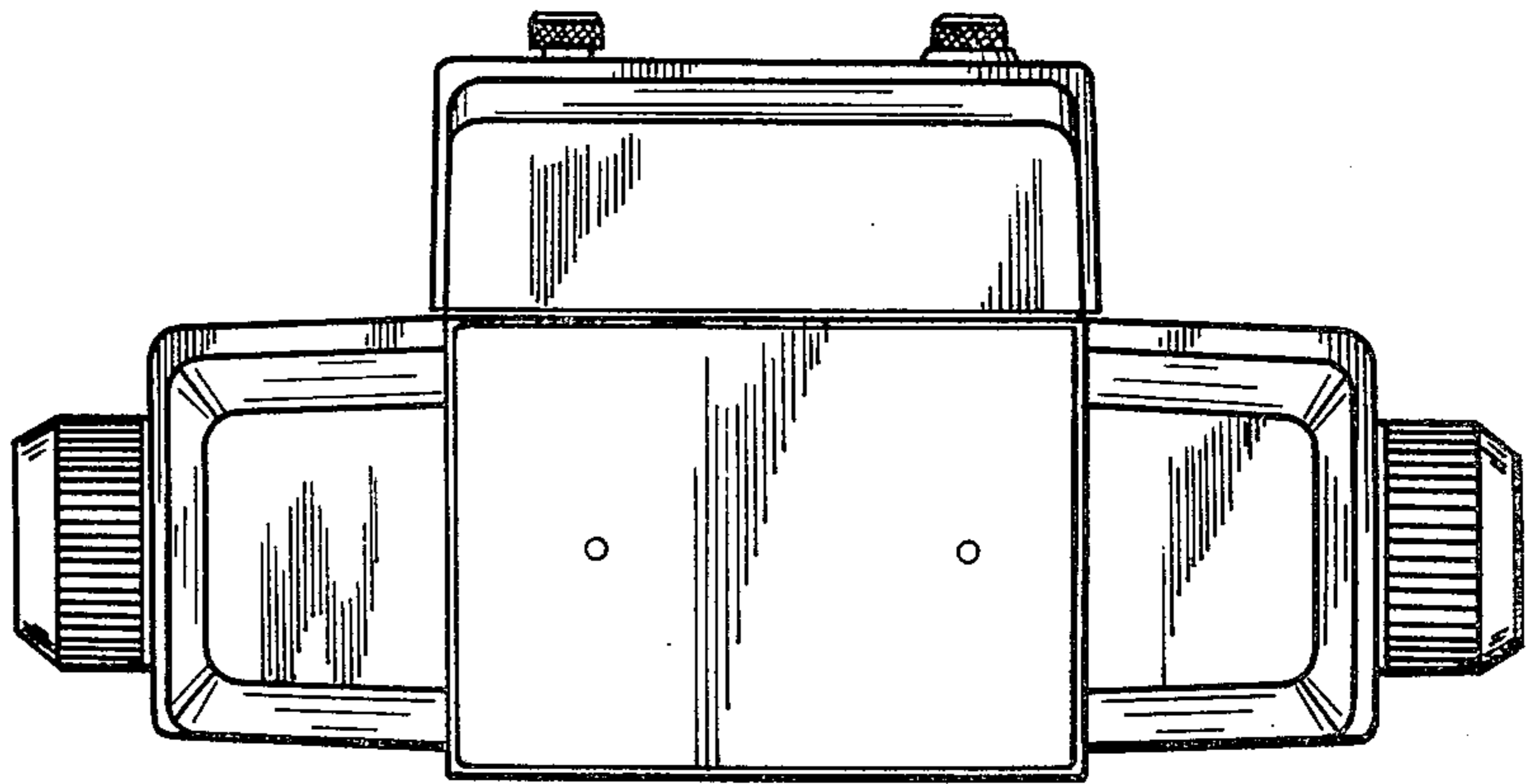

Fig-2

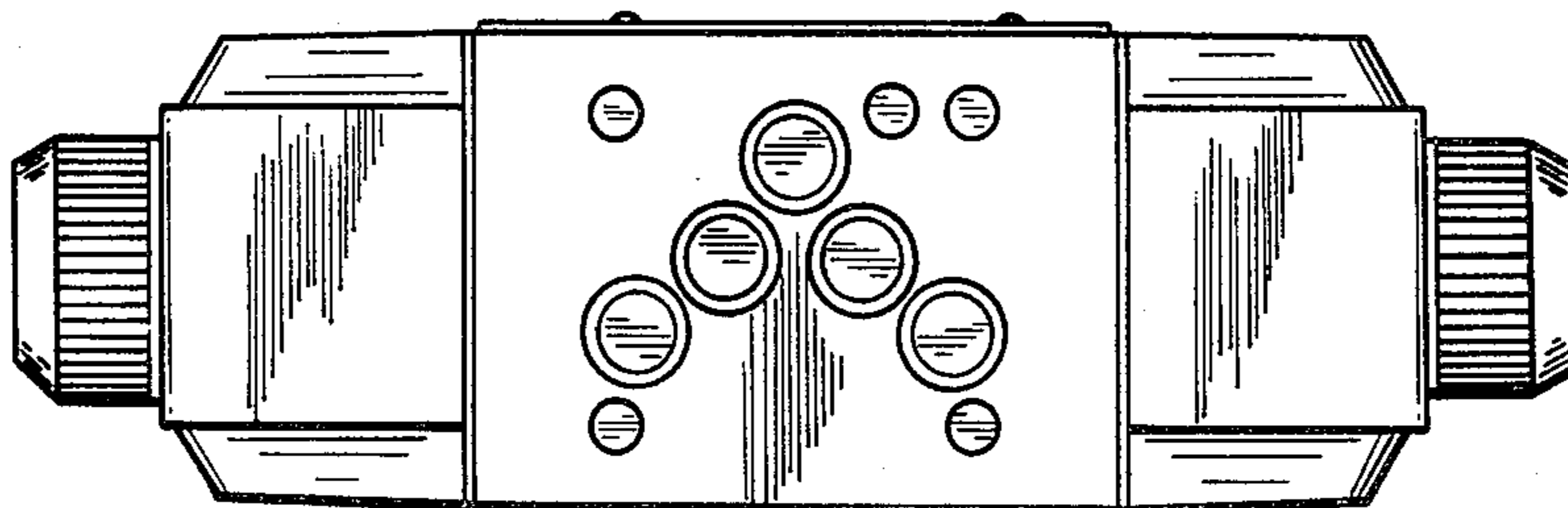

Fig-3

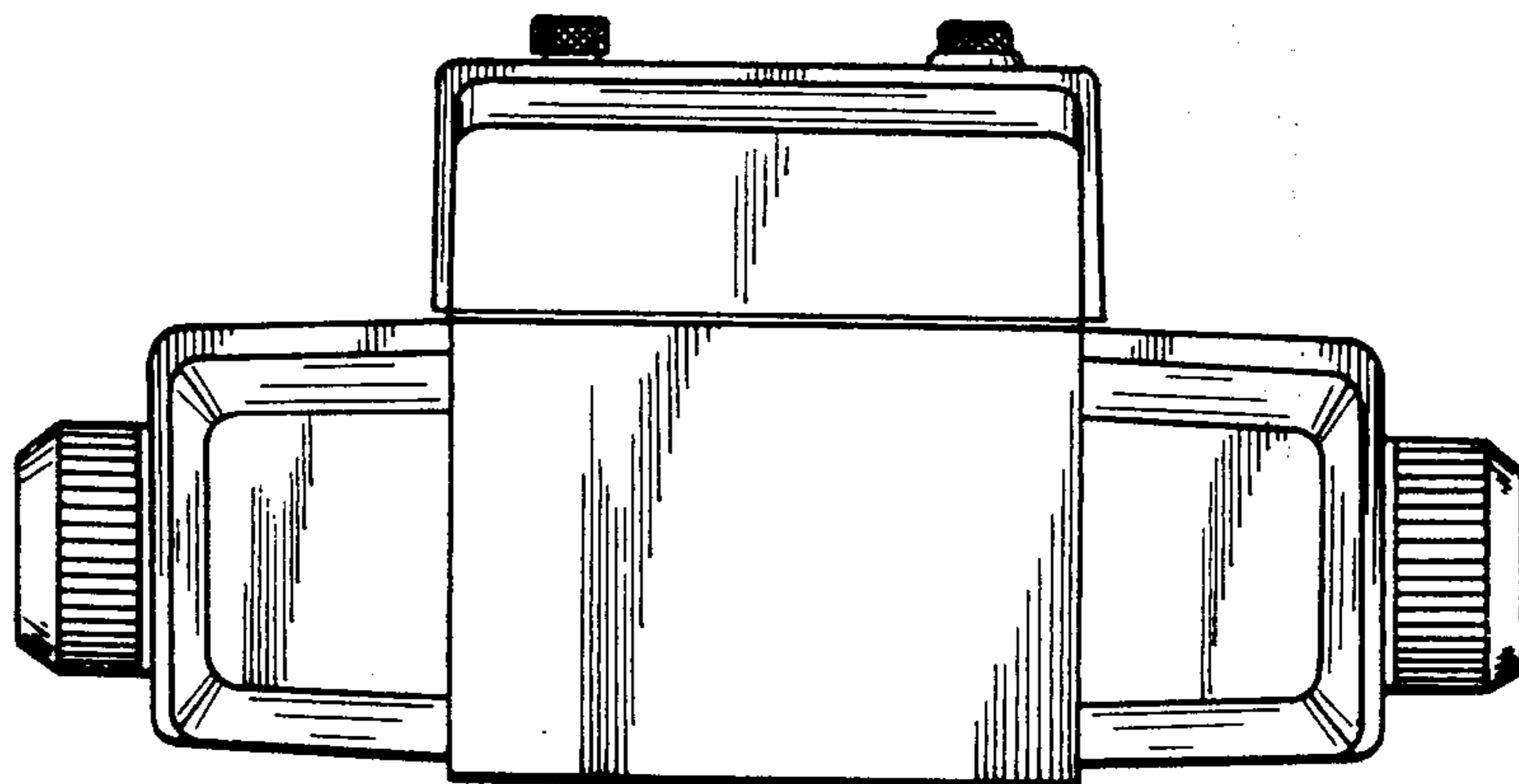

Fig-4

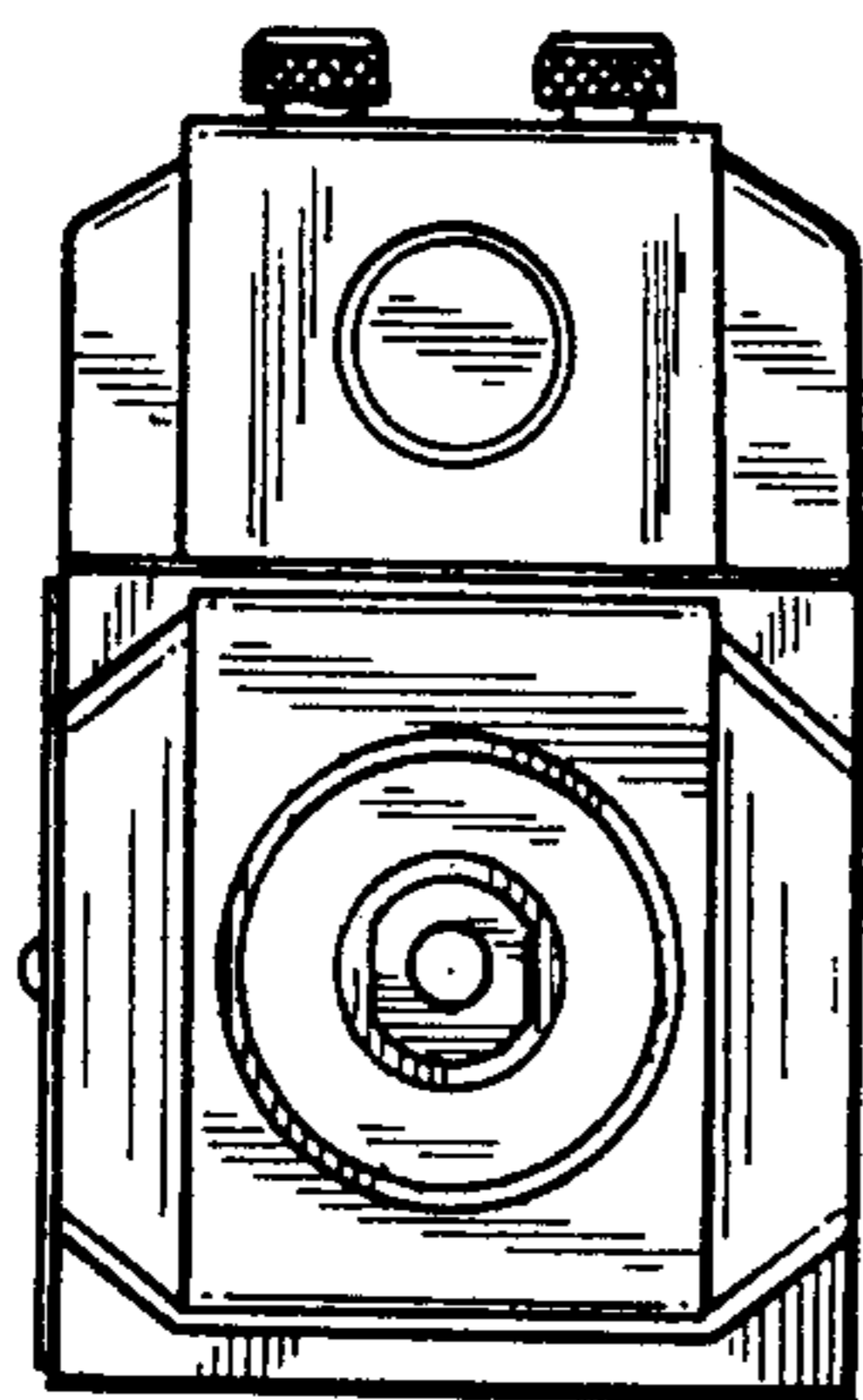

Fig-5

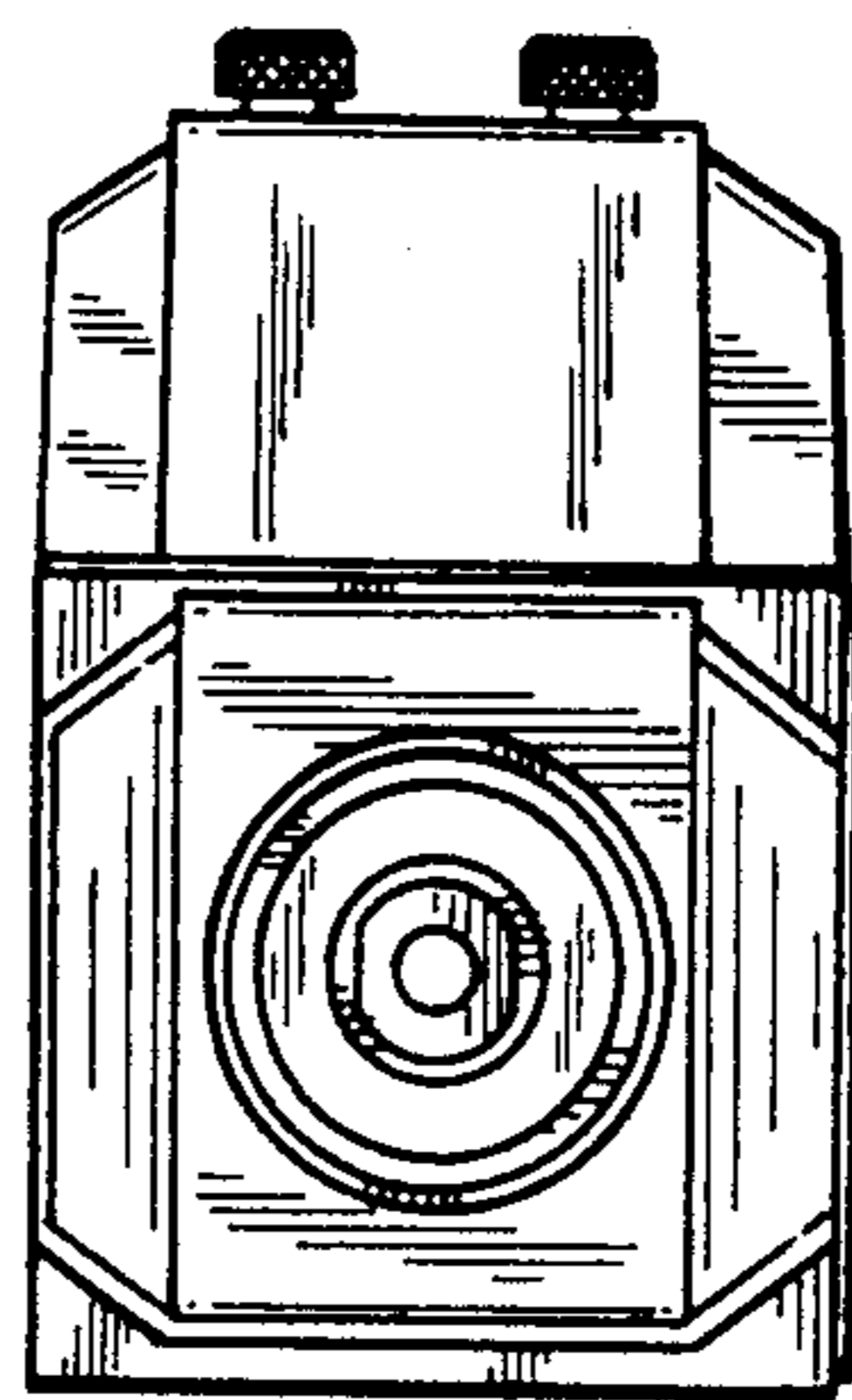
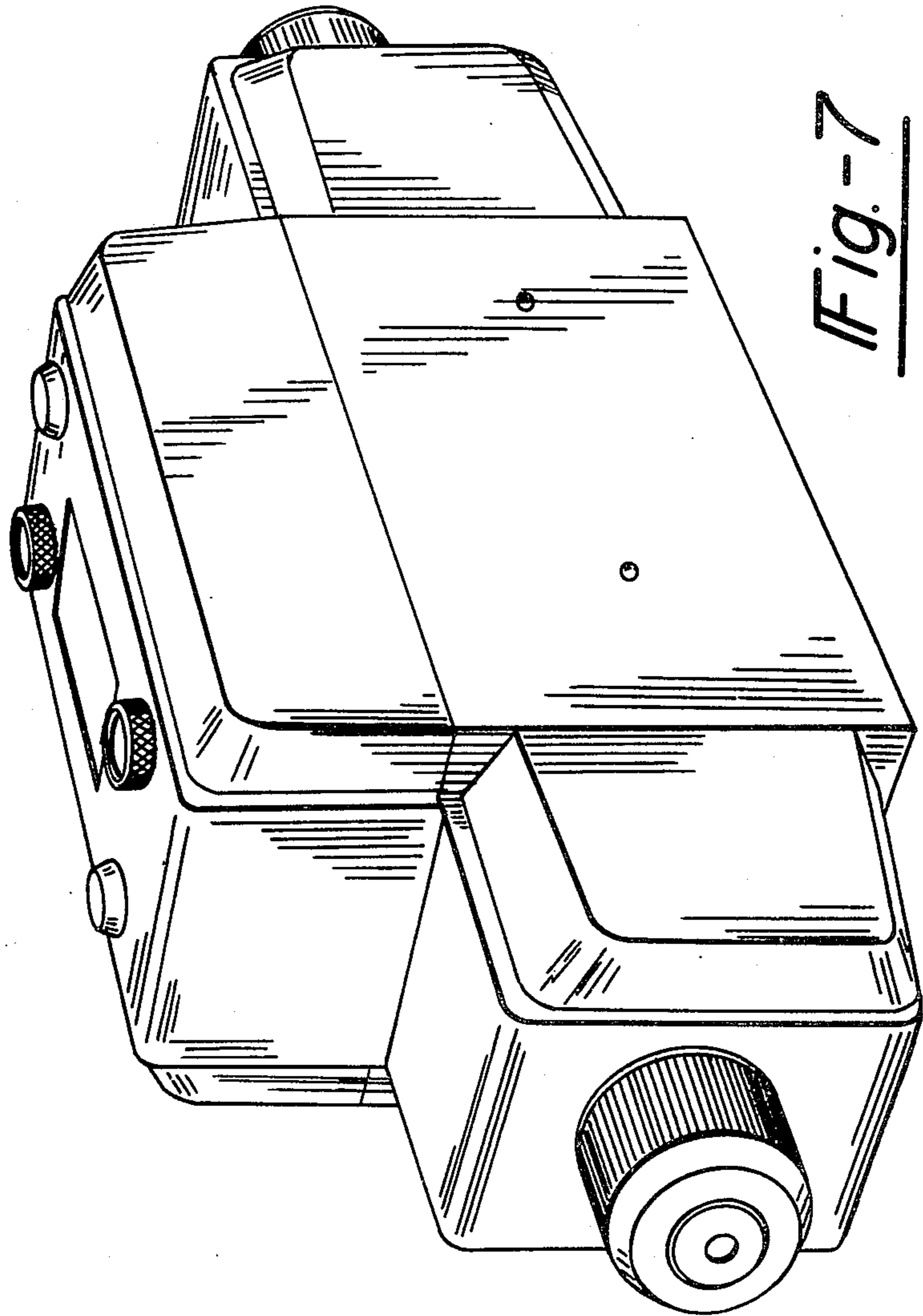

Fig-6



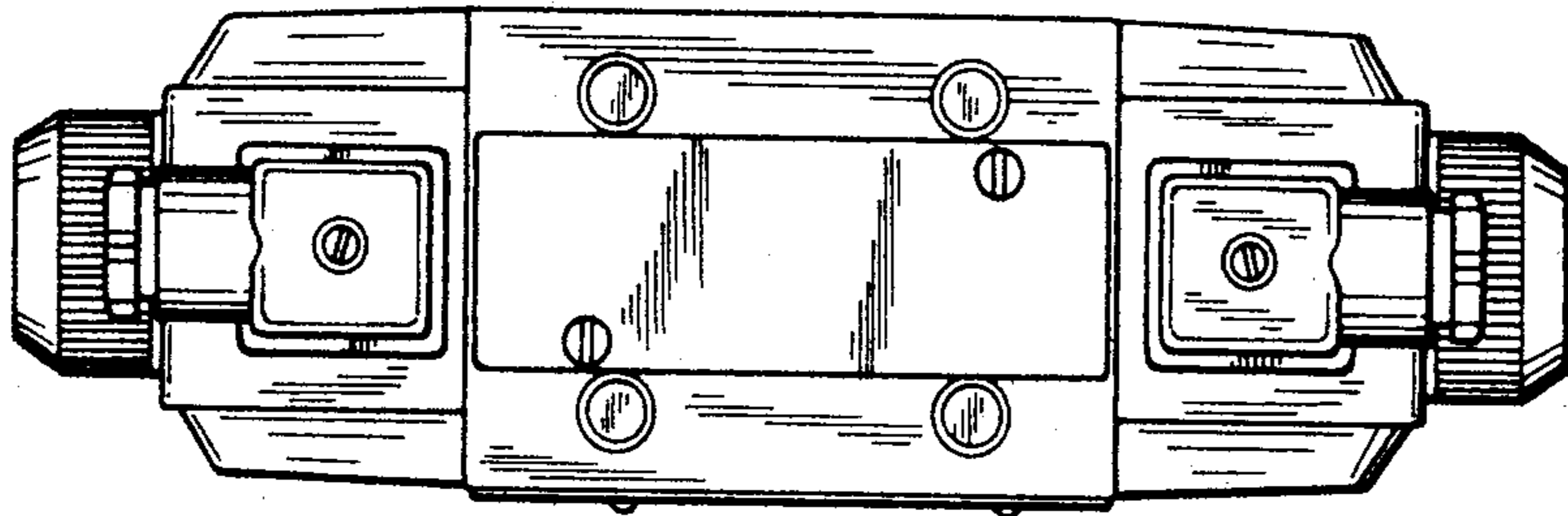

Fig-8

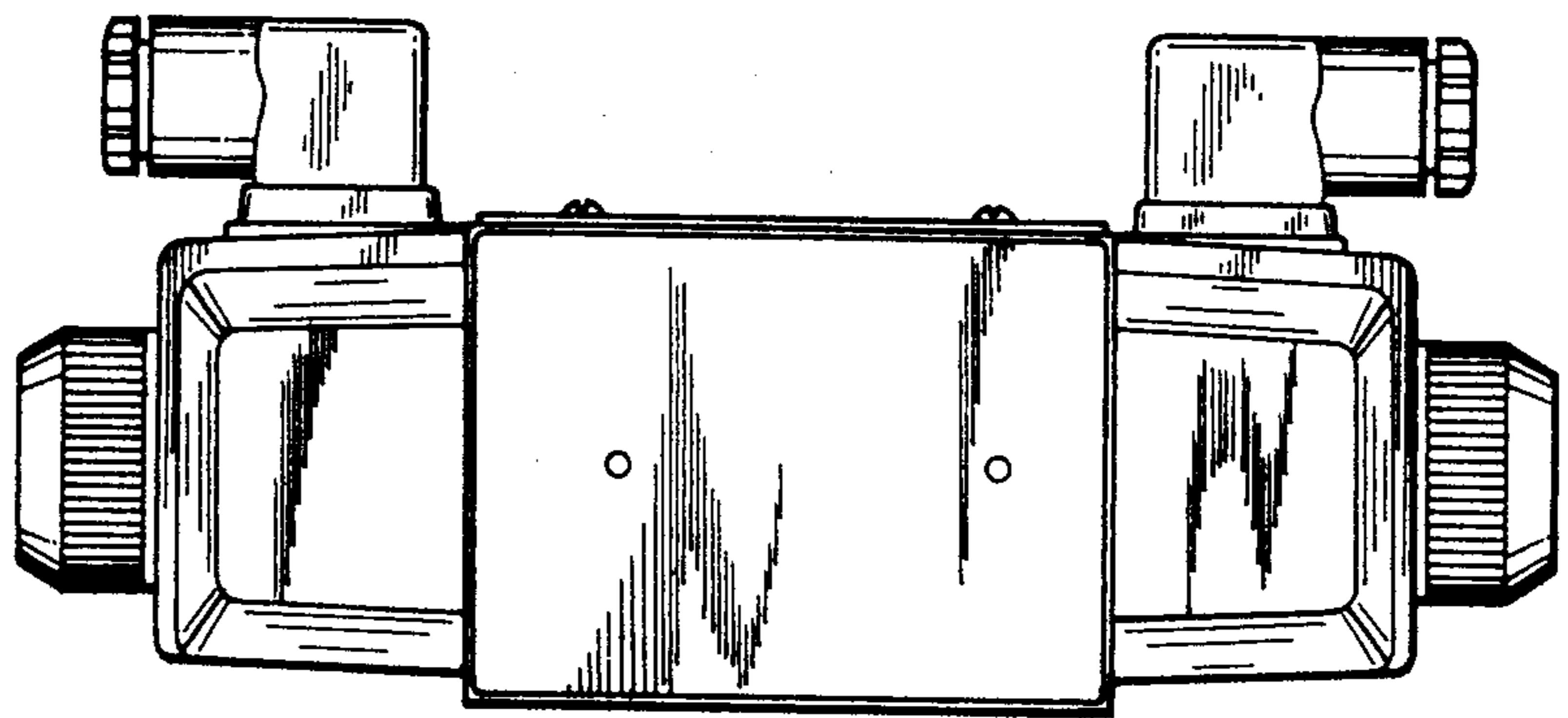

Fig-9

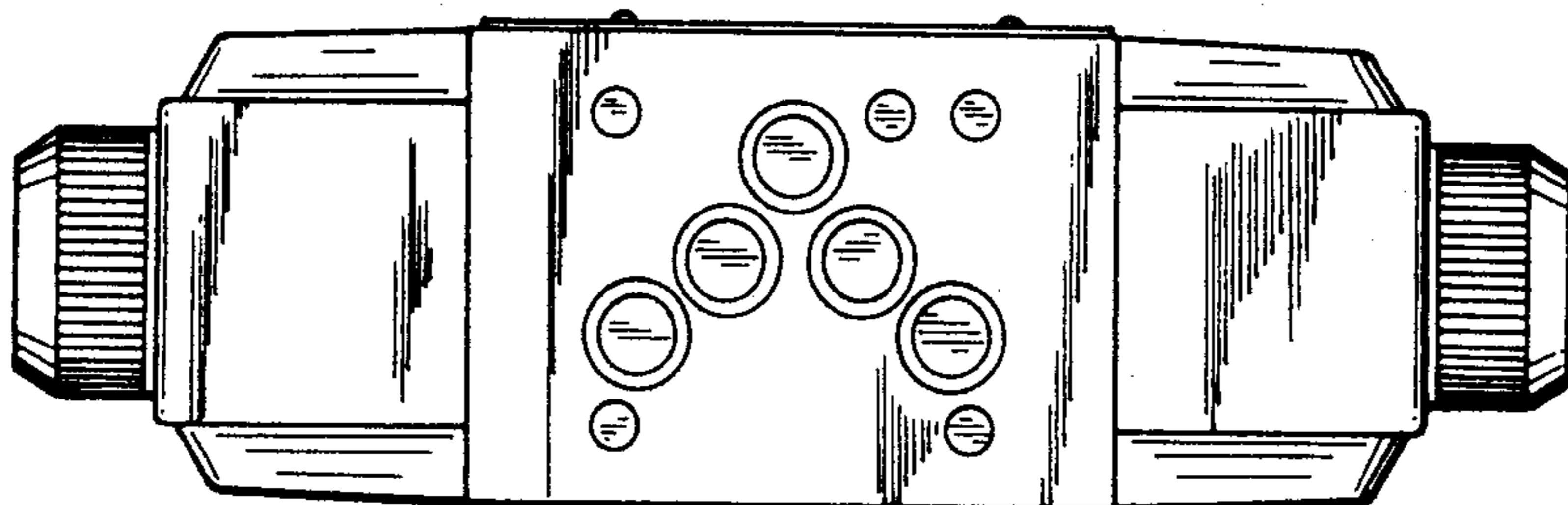

Fig-10

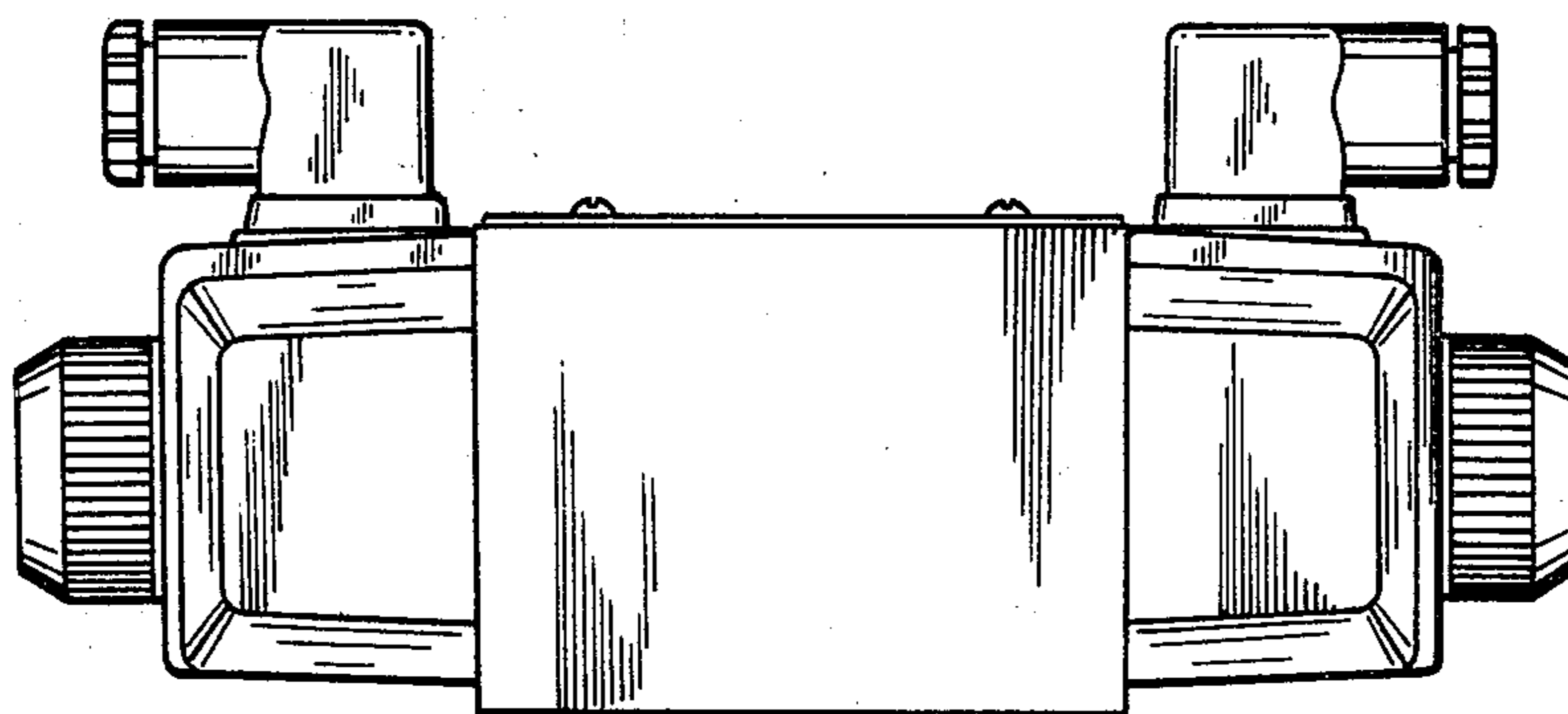

Fig-11

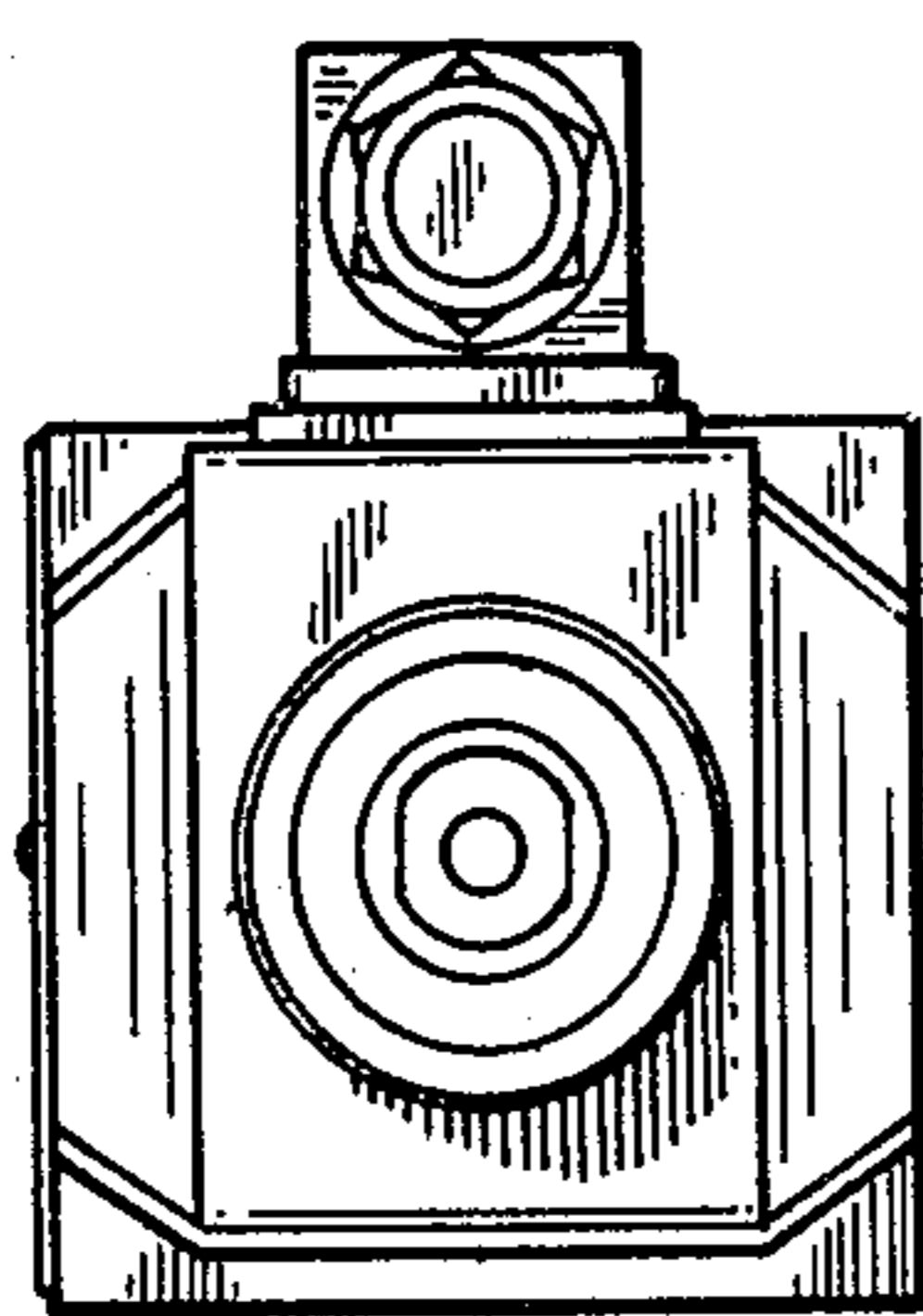

Fig-12

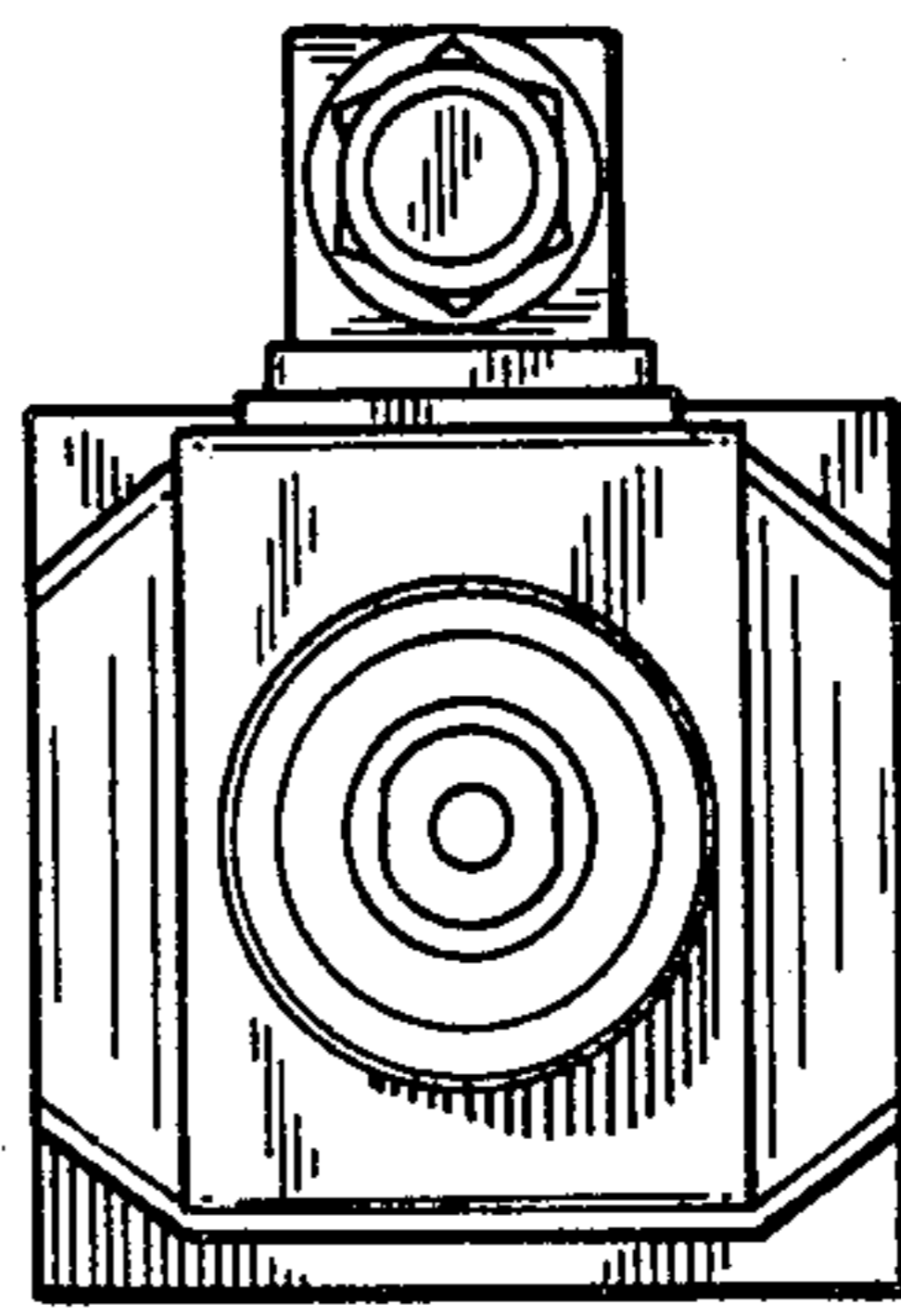

Fig-13