

[54] WALL MOUNTED HOLDER FOR THE EXPOSURE OF VARIOUS KINDS OF BANDAGING MATERIALS

[75] Inventor: Roger Adolfsson, Stockholm, Sweden

[73] Assignee: Cederroths AB, Sweden

[**] Term: 14 Years

[21] Appl. No.: 240,781

[22] Filed: Mar. 5, 1981

[52] U.S. Cl. D6/130; D6/114; D24/31

[58] Field of Search 86/114, 130, 136; D24/31; 211/13, 87

[56] References Cited

U.S. PATENT DOCUMENTS

- D. 224,772 9/1972 Hurley D6/130
- D. 233,289 10/1974 Barone D6/130
- D. 234,557 3/1975 Tiburzi D6/136

Primary Examiner—B. J. Bullock

Attorney, Agent, or Firm—Lerner, David, Littenberg, Krumholz & Mentlik

[57] CLAIM

The ornamental design for a wall mounted holder for

the exposure of various kinds of bandaging materials, substantially as shown and described.

DESCRIPTION

FIG. 1 is an enlarged front perspective view of a wall mounted holder for the exposure of various kinds of bandaging materials showing my new design; FIG. 2 is a rear elevational view of FIG. 1; FIG. 3 is a side elevational view taken from the left of FIG. 1, the side opposite being substantially a mirror image thereof; FIG. 4 is a top plan view of FIG. 1; FIG. 5 is a bottom plan view of FIG. 1; FIG. 6 is an enlarged front perspective view of a second embodiment of the design of FIG. 1, the rear being substantially identical to FIG. 2; FIG. 7 is a side elevational view taken from the left of FIG. 6; FIG. 8 is a side elevational view taken from the right of FIG. 6; FIG. 9 is a top plan view of FIG. 6; FIG. 10 is a bottom plan view of FIG. 6; FIG. 11 is an enlarged front perspective view of a third embodiment of FIG. 1; FIG. 12 is a side elevational view taken from the right of FIG. 11, the side opposite being substantially a mirror image thereof; FIG. 13 is a top plan view of FIG. 11; FIG. 14 is a bottom plan view of FIG. 11; and FIG. 15 is a rear elevational view of FIG. 11.

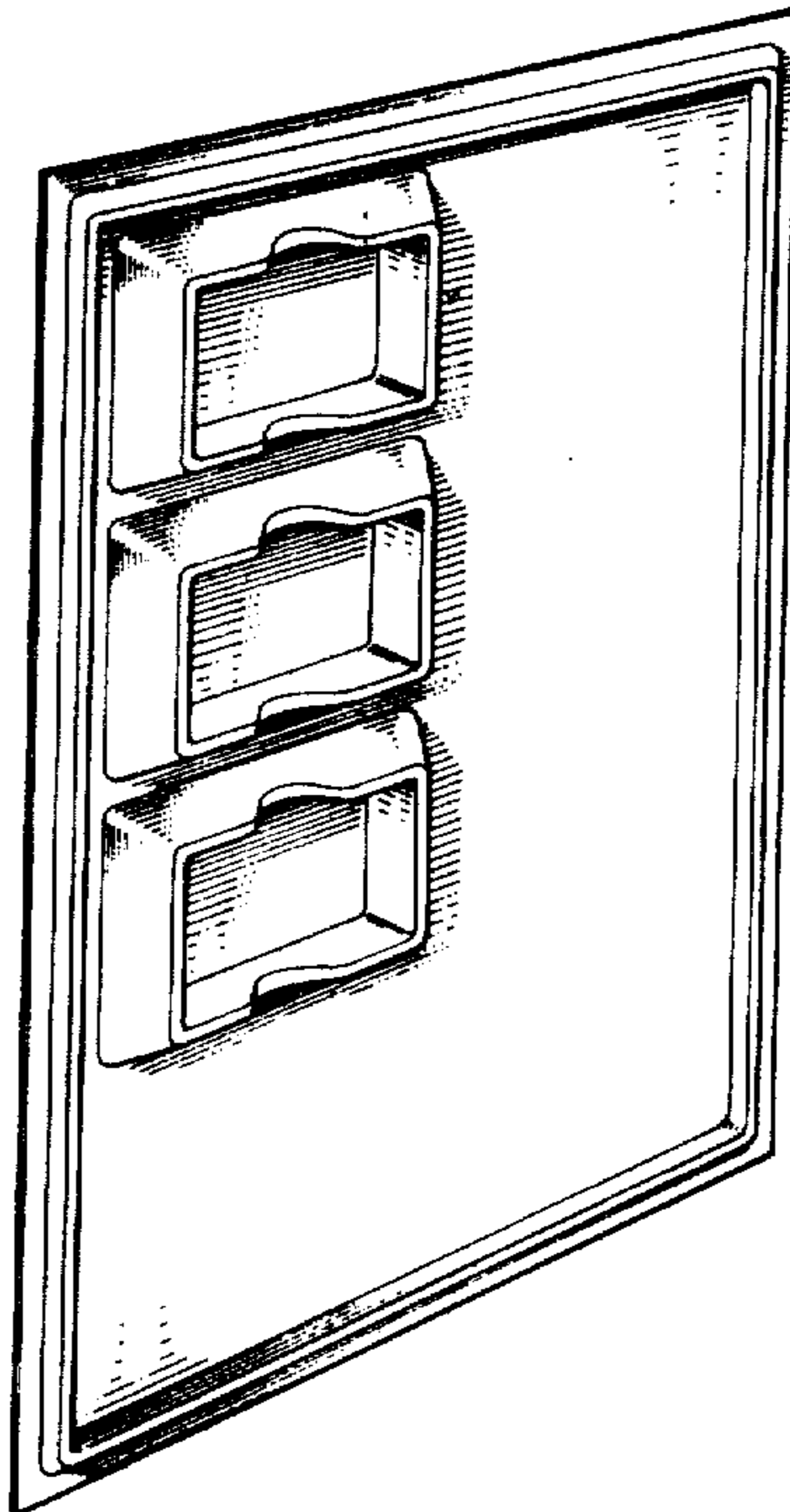

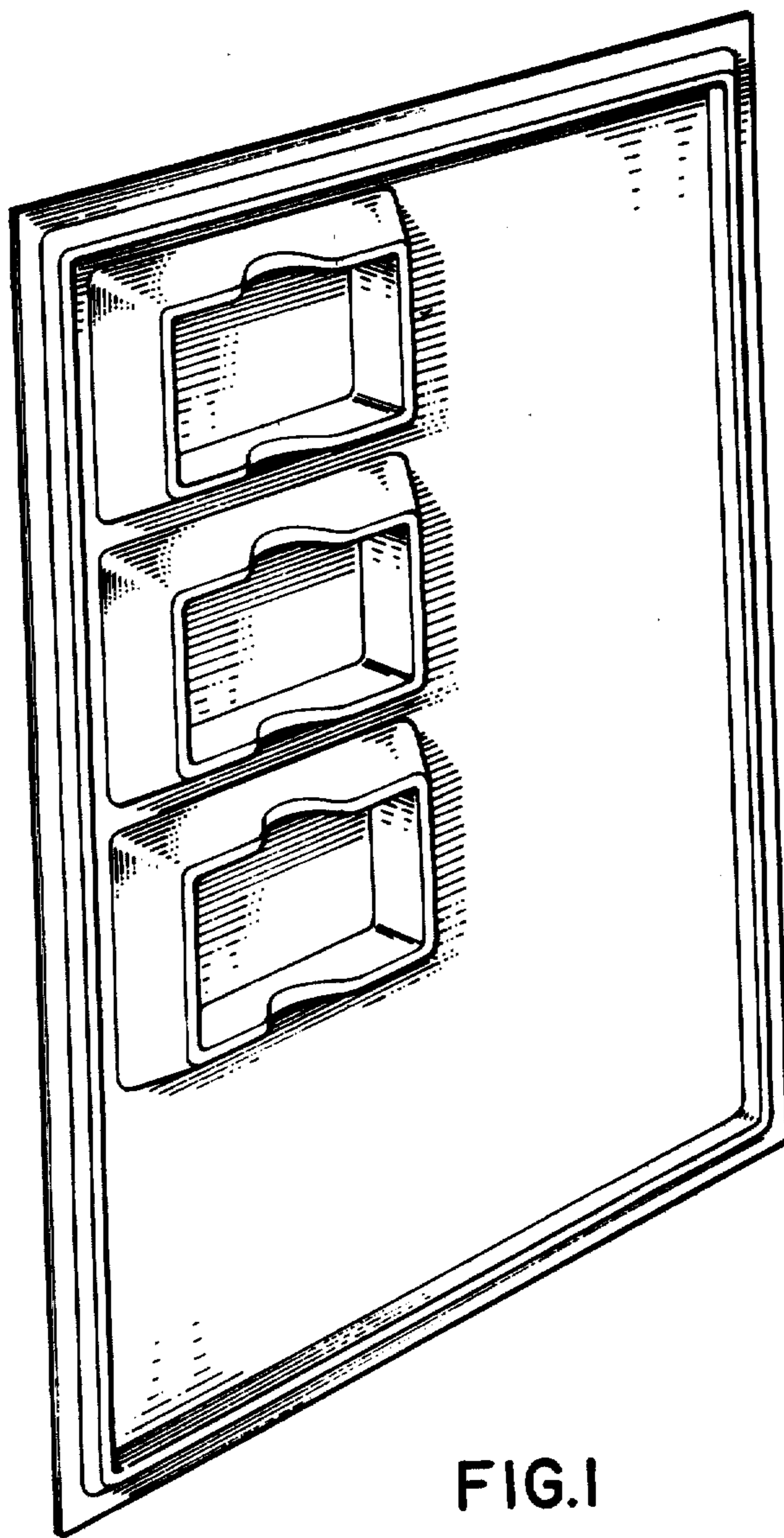

FIG.1

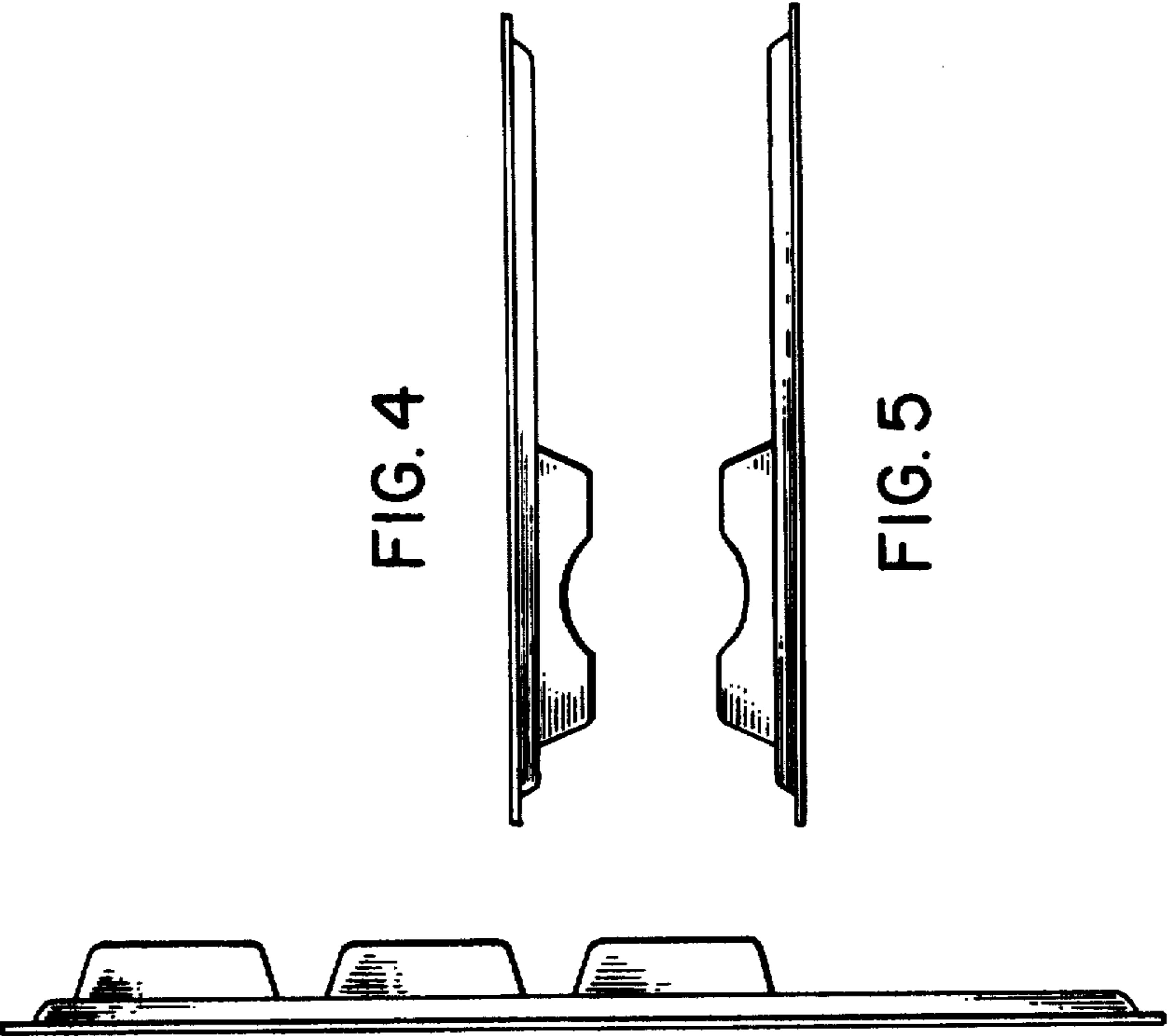

FIG. 3

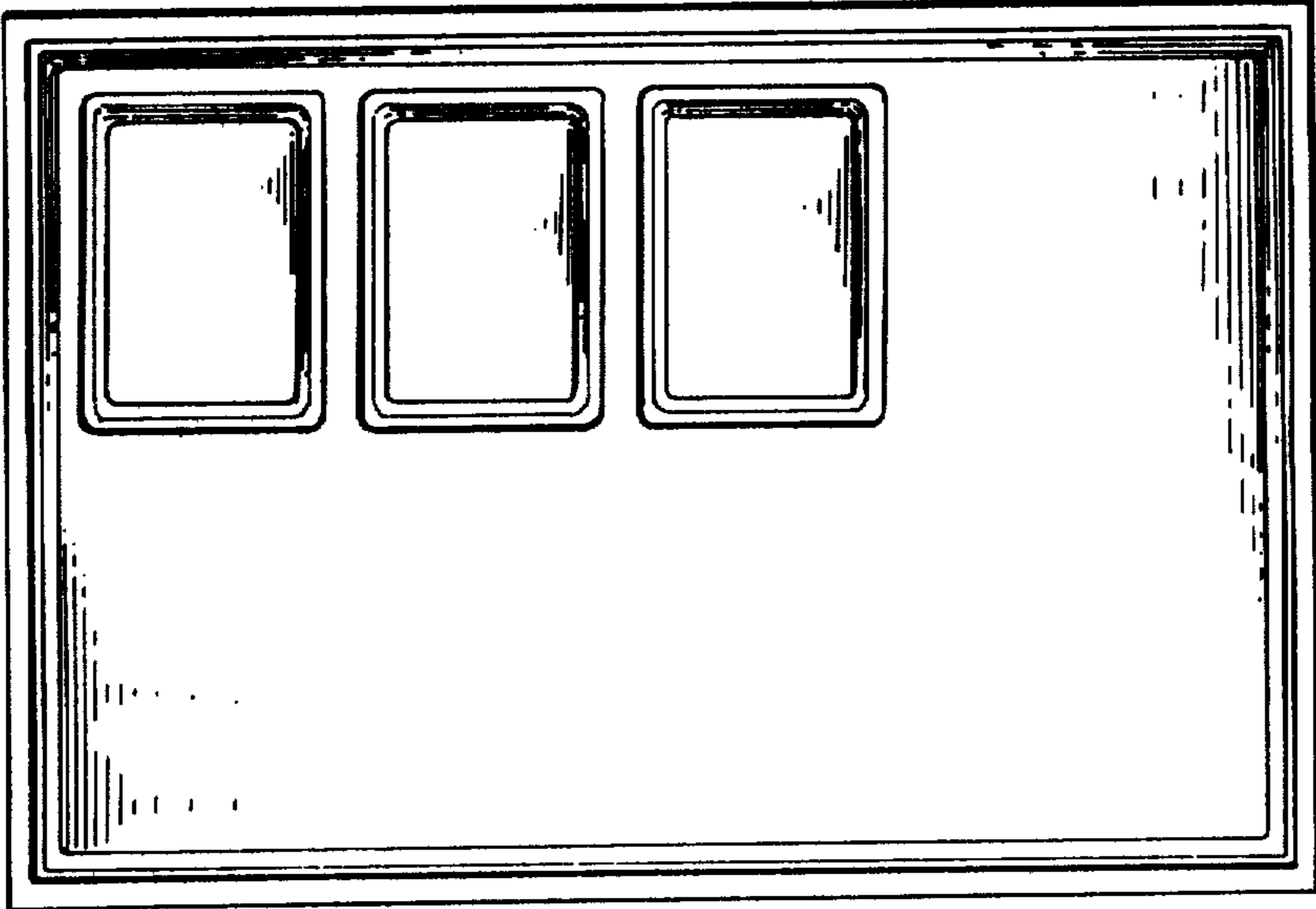

FIG. 2

FIG. 4



FIG. 5



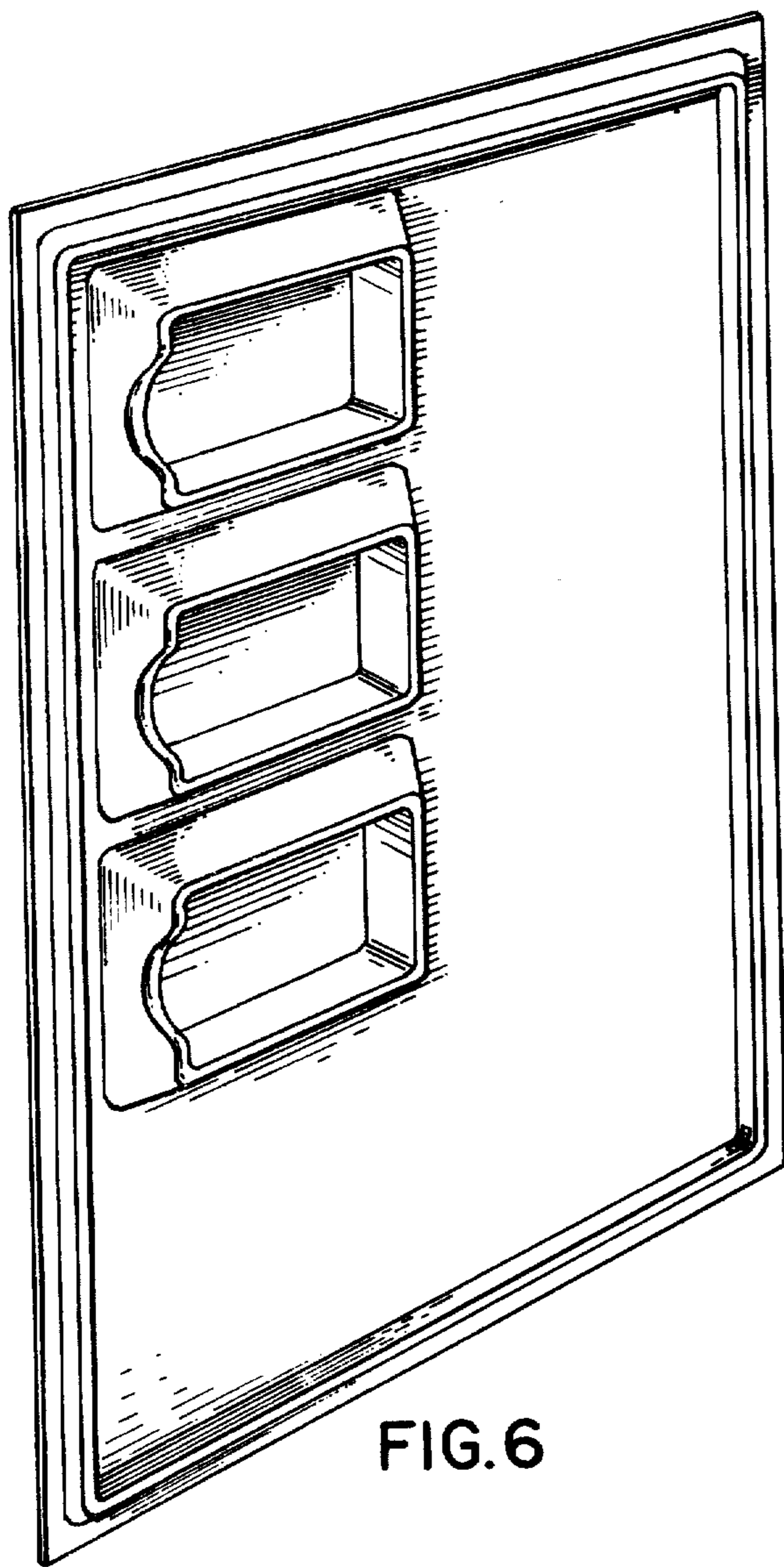

FIG. 6

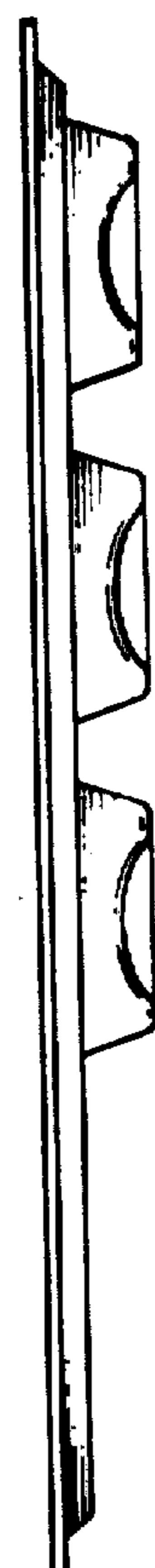

FIG. 7



FIG. 8

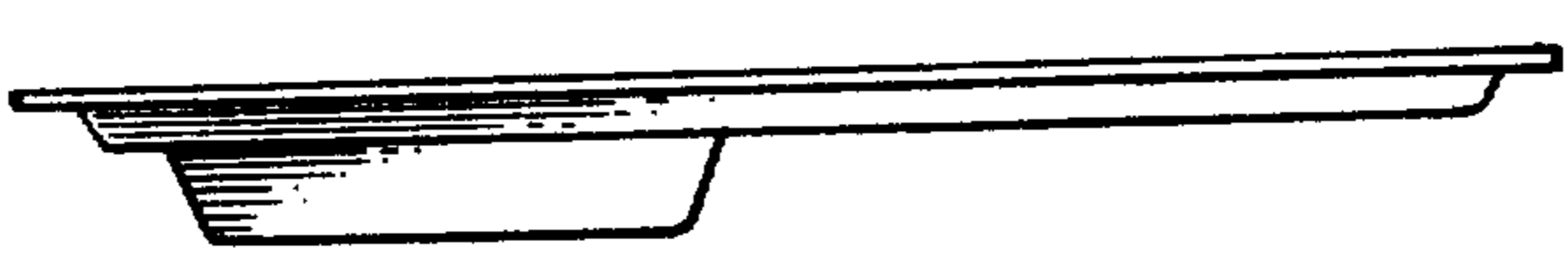

FIG. 9



FIG. 10

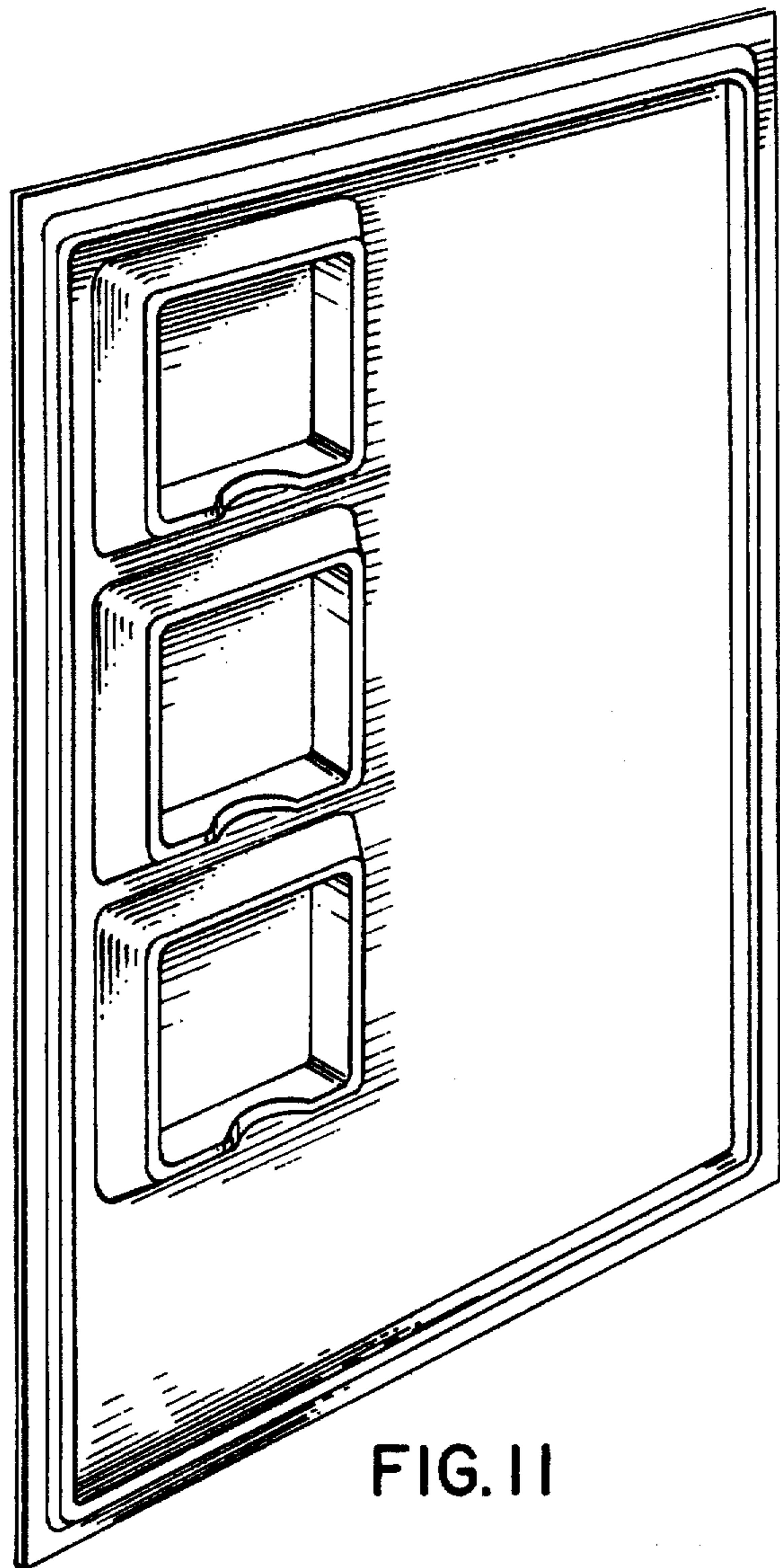

FIG. 11



FIG. 12

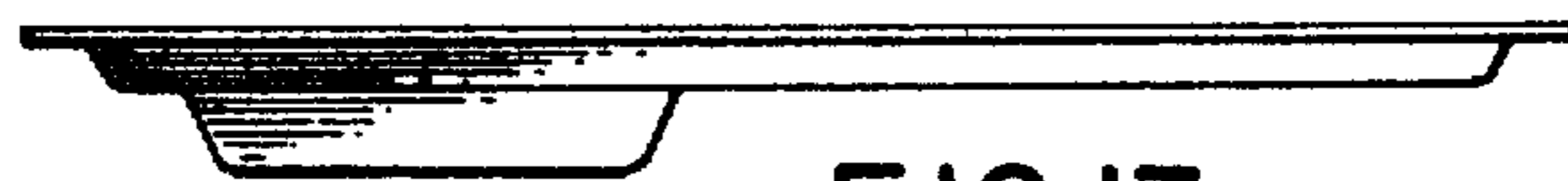

FIG. 13



FIG. 14

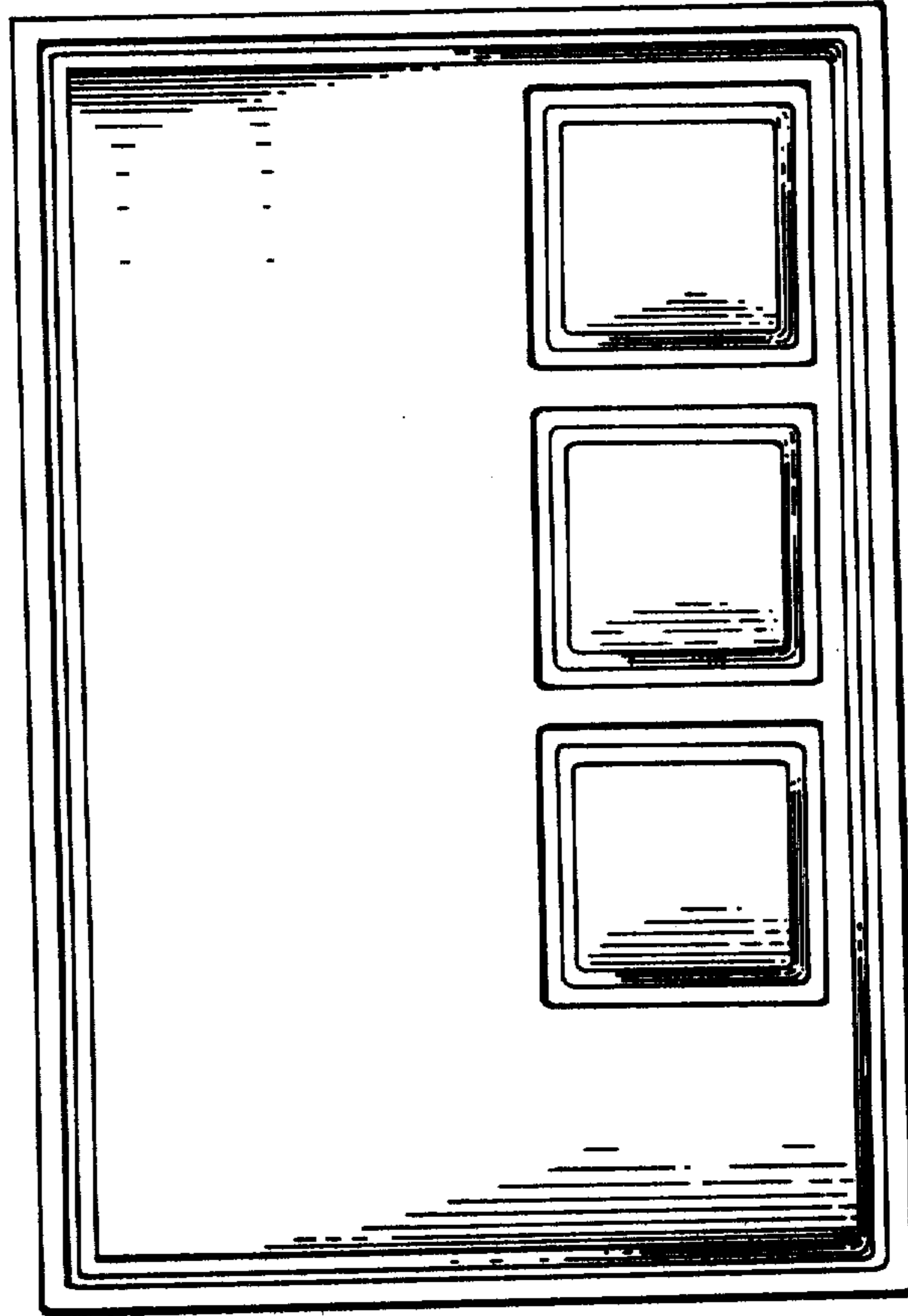

FIG. 15