

[54] **FIREPLACE HEAT EXCHANGER**

[75] Inventor: **Keith J. Davidson**, Dorchester,
Canada

[73] Assignee: **432698 Ontario Ltd.**, Dorchester,
Canada

[**] Term: **14 Years**

[21] Appl. No.: **290,834**

[22] Filed: **Aug. 7, 1981**

[30] **Foreign Application Priority Data**
Feb. 9, 1981 [CA] Canada 09-02-81-5

[52] U.S. Cl. **D23/135; D23/94;**
D23/138.2; D23/95

[58] **Field of Search** **D23/94-96,**
D23/127, 135, 136, 138.2, 138.4; 126/120, 121,
163, 164, 165, 298

[56] **References Cited**

U.S. PATENT DOCUMENTS

D. 253,067 10/1979 Hartley D23/138.2 X
4,010,729 3/1977 Egli 126/121
4,170,217 10/1979 Mayes 126/121
4,271,814 6/1981 Lister 126/121

FOREIGN PATENT DOCUMENTS

47387 10/1980 Canada .

Primary Examiner—Catherine E. Kemper

[57] **CLAIM**

The ornamental design for a fireplace heat exchanger,
as shown and described.

DESCRIPTION

FIG. 1 is a front elevational view of a fireplace heat exchanger, showing my new design;
FIG. 2 is a rear elevational view thereof;
FIG. 3 is a right side elevational view thereof;
FIG. 4 is a top plan view thereof;
FIG. 5 is a bottom plan view thereof;
FIG. 6 is a left side elevational view thereof;
FIG. 7 is a perspective view thereof.

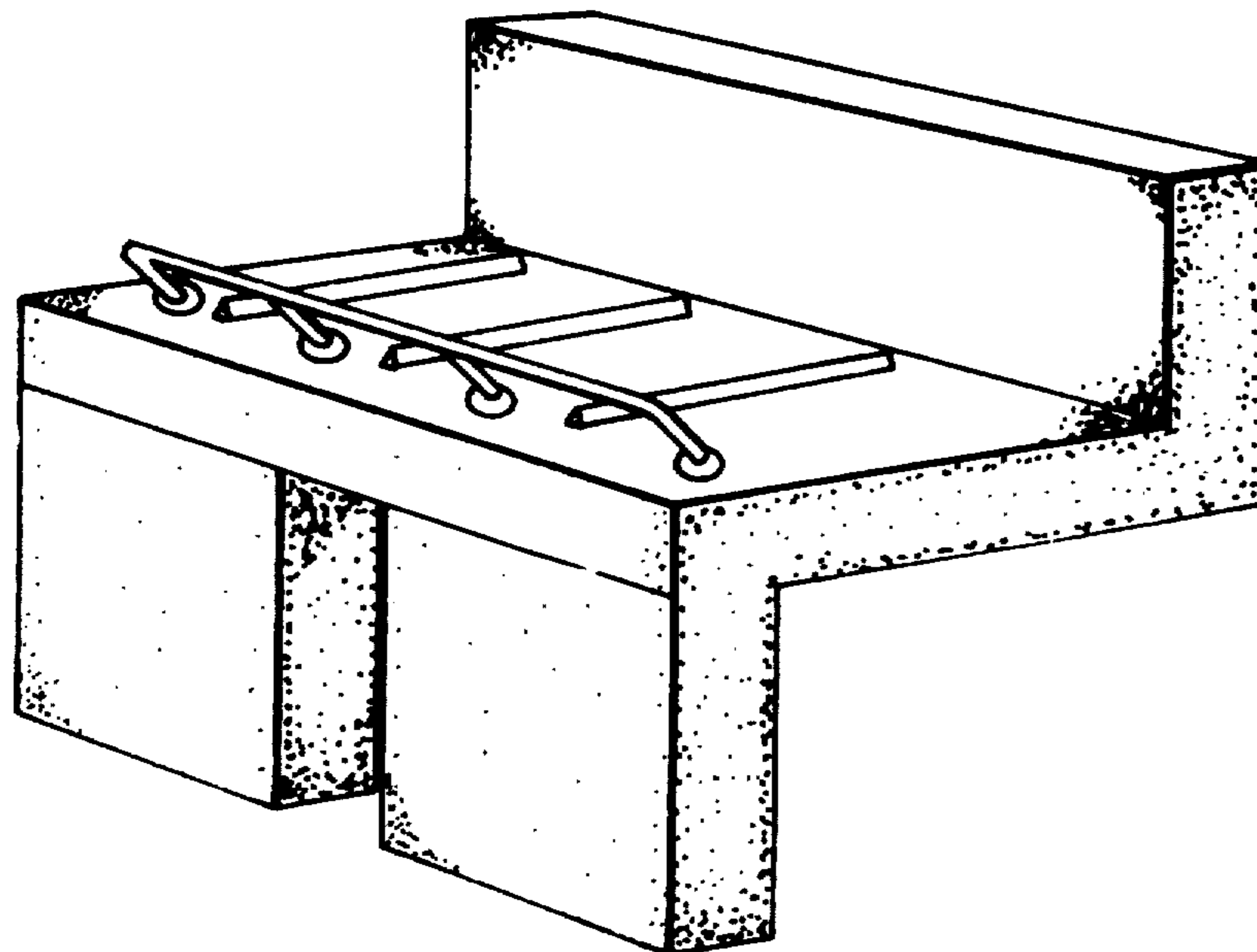

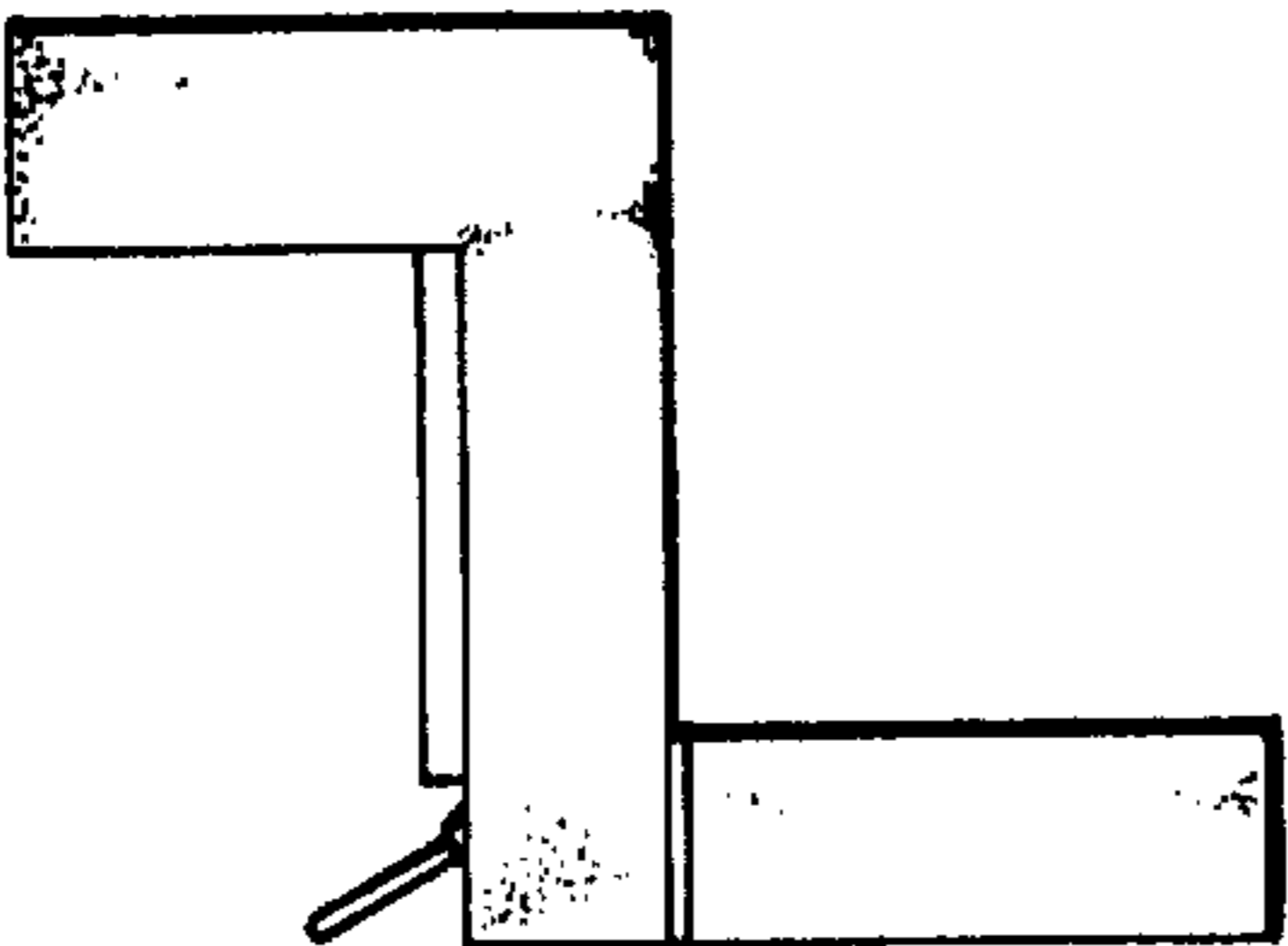

FIG. 3

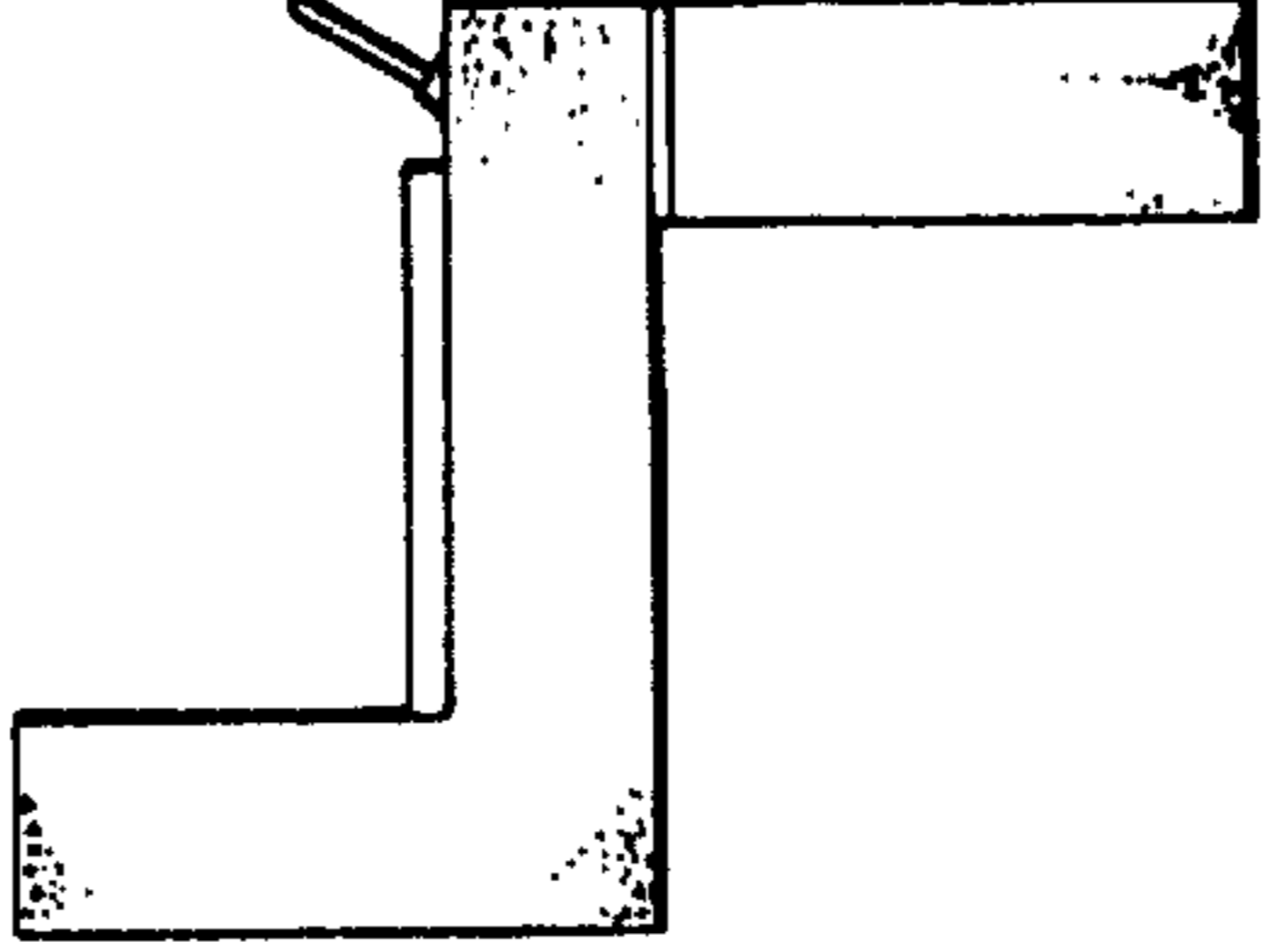

FIG. 6

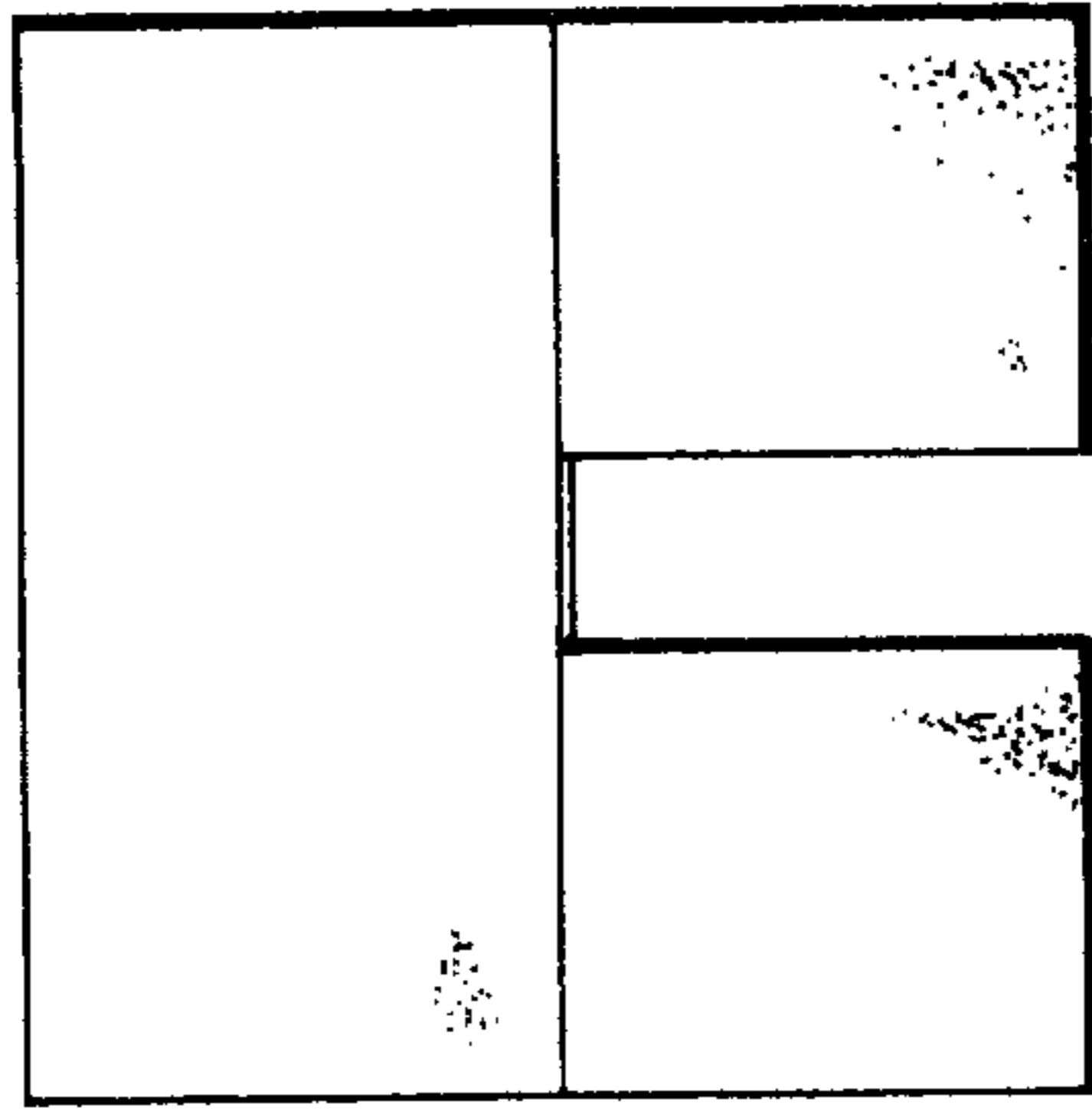

FIG. 2

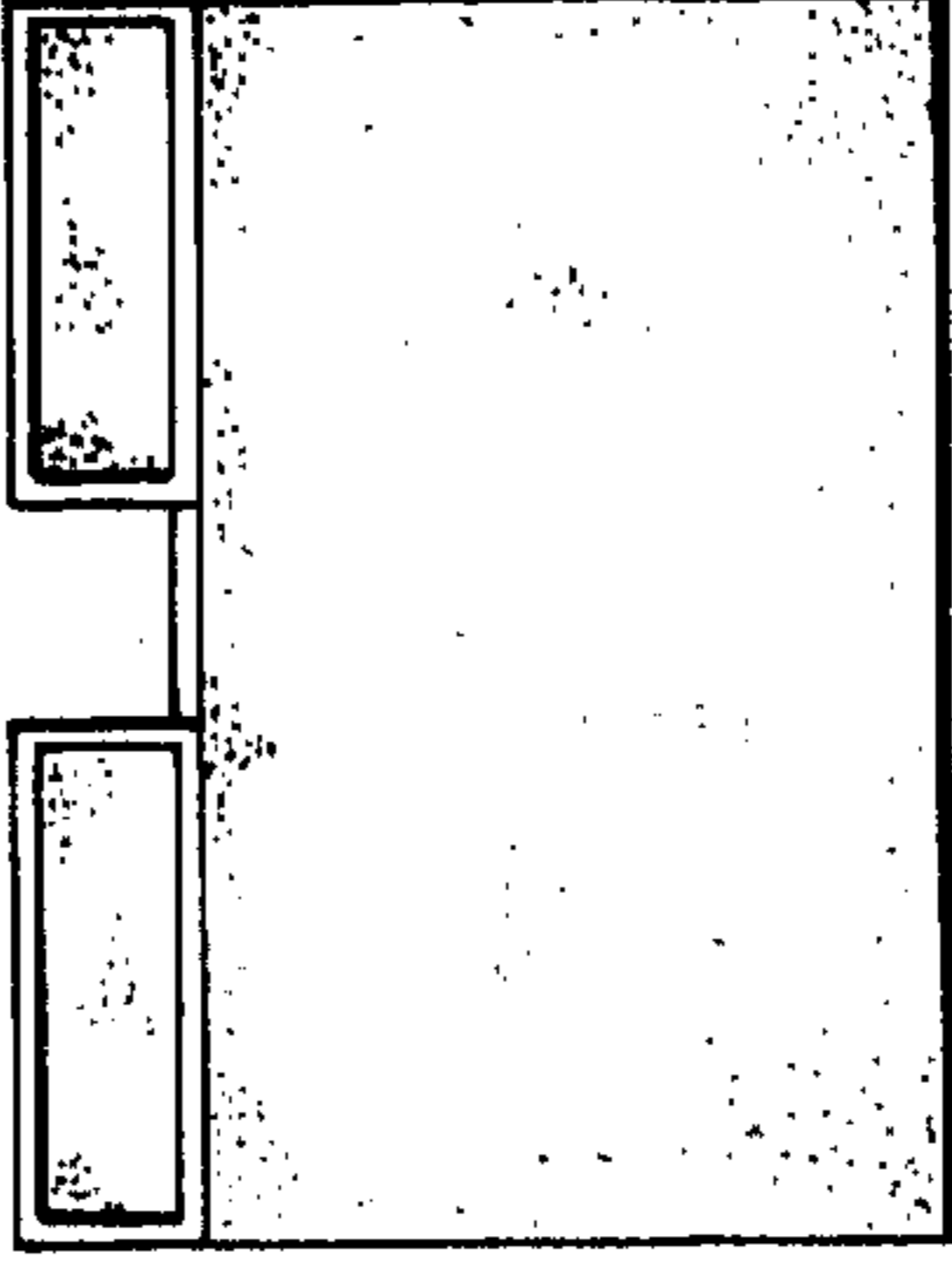

FIG. 5

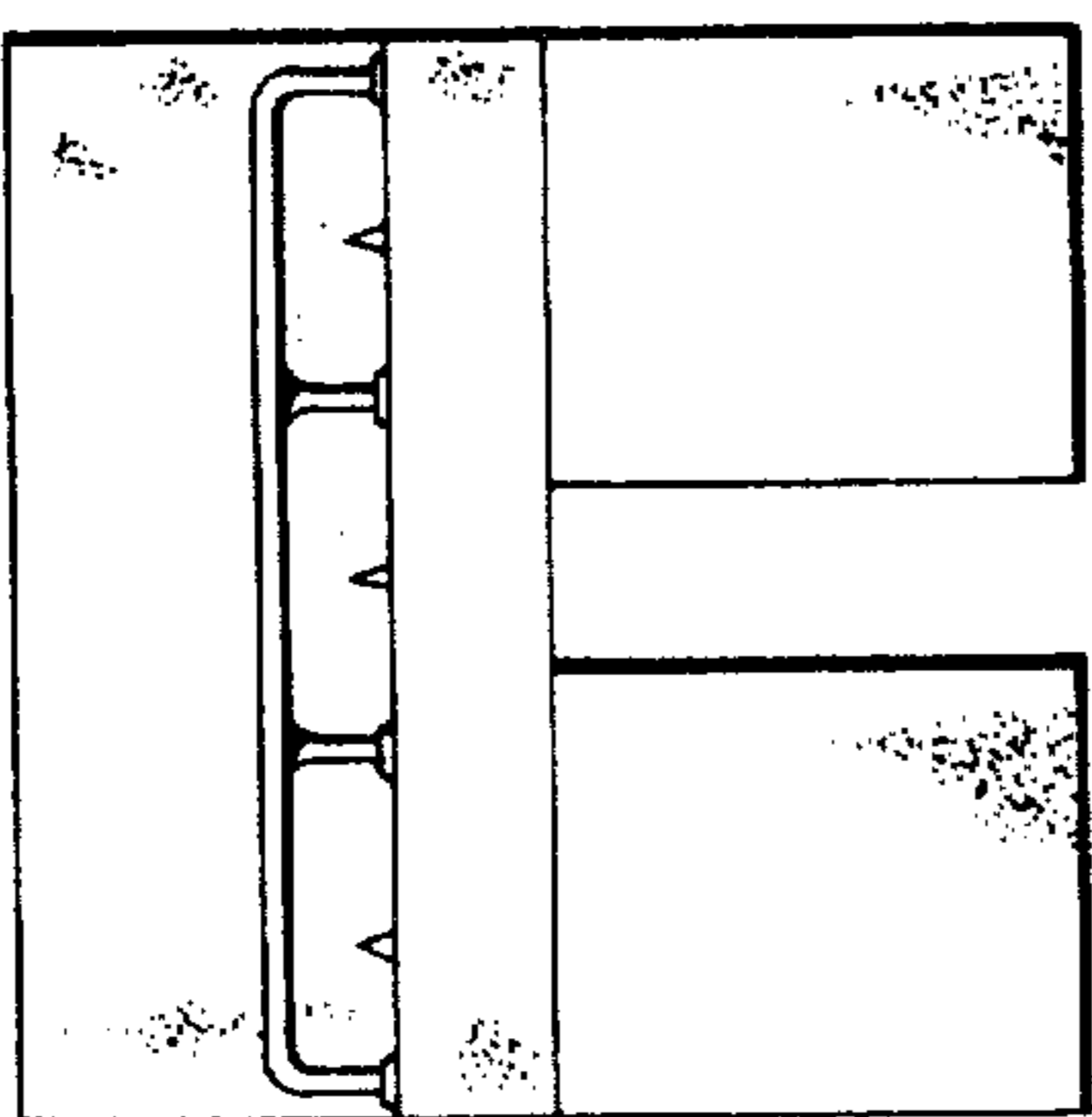

FIG. 1

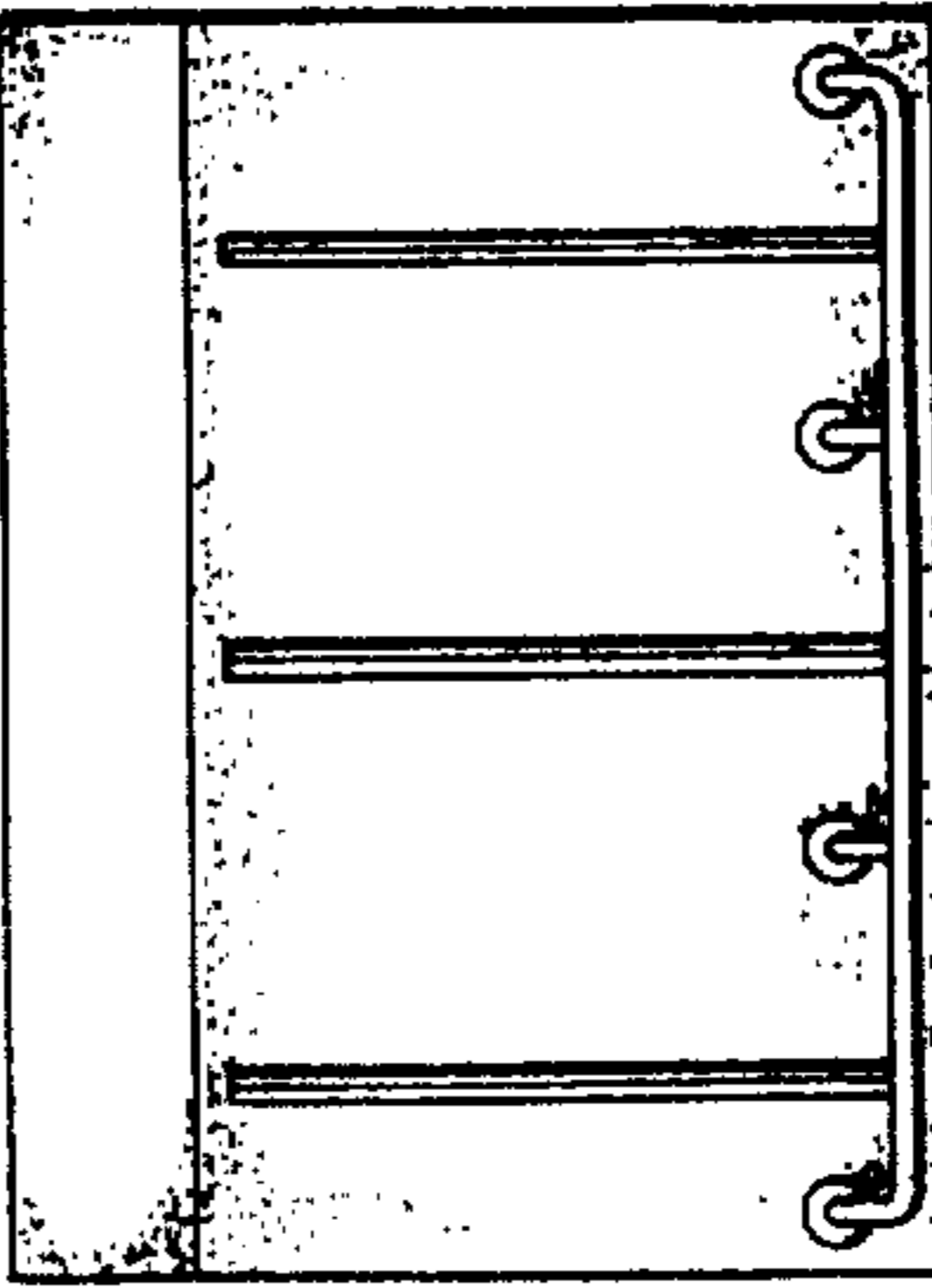

FIG. 4

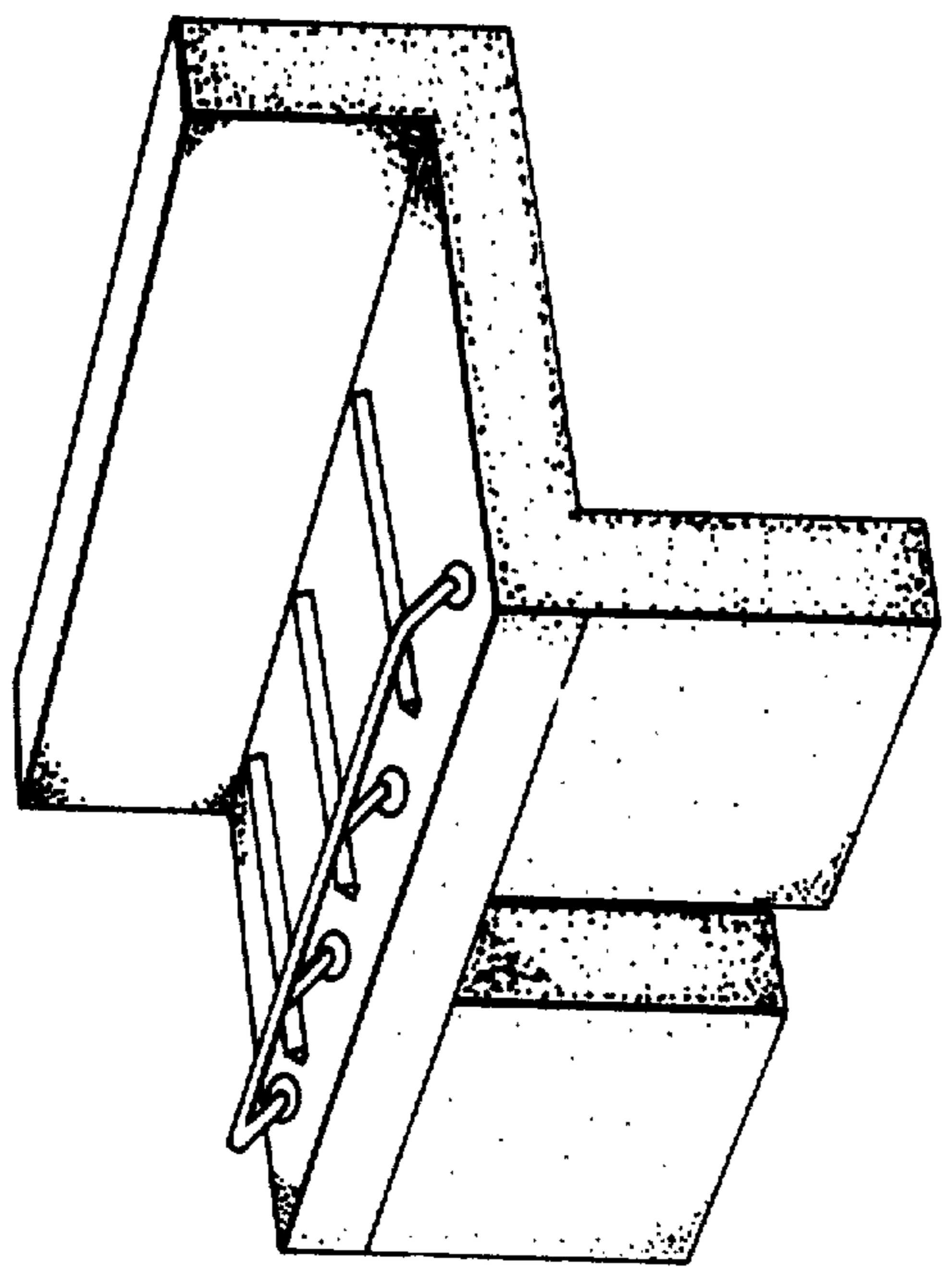

FIG. 7