

[54] COMBINED TOOTHPASTE DISPENSER AND TOOTHBRUSH HOLDER

[76] Inventor: Gilbert E. Barrera, 11354 Vance Jackson, San Antonio, Tex. 78230

[**] Term: 14 Years

[21] Appl. No.: 285,865

[22] Filed: Jul. 22, 1981

[52] U.S. Cl. D6/87; D6/91

[58] Field of Search D6/86, 87; 206/277; 222/93, 95, 103

3,961,727 6/1976 Spears 222/103
4,019,656 4/1977 Spears 222/103
4,172,536 10/1979 Holt 222/103

Primary Examiner—Wallace R. Burke
Assistant Examiner—Suzanne N. Gitlin
Attorney, Agent, or Firm—Gale R. Peterson

[57] CLAIM

The ornamental design for a combined toothpaste dispenser and toothbrush holder, as shown and described.

DESCRIPTION

FIG. 1 is a perspective view of a combined toothpaste dispenser and toothbrush holder showing my new design;

FIG. 2 is a front end view thereof;

FIG. 3 is a rear end view thereof;

FIG. 4 is a right side view thereof;

FIG. 5 is a left side view thereof;

FIG. 6 is a bottom view thereof;

FIG. 7 is a top view thereof.

[56] References Cited

U.S. PATENT DOCUMENTS

D. 204,050	3/1966	Scott	D6/87
D. 267,993	2/1983	Barrera	D6/87
3,155,278	11/1964	Baron	222/93
3,450,309	6/1969	DiMillo	222/103
3,768,699	10/1973	Robe, Jr.	222/103
3,893,590	7/1975	Paroussiadis	222/103

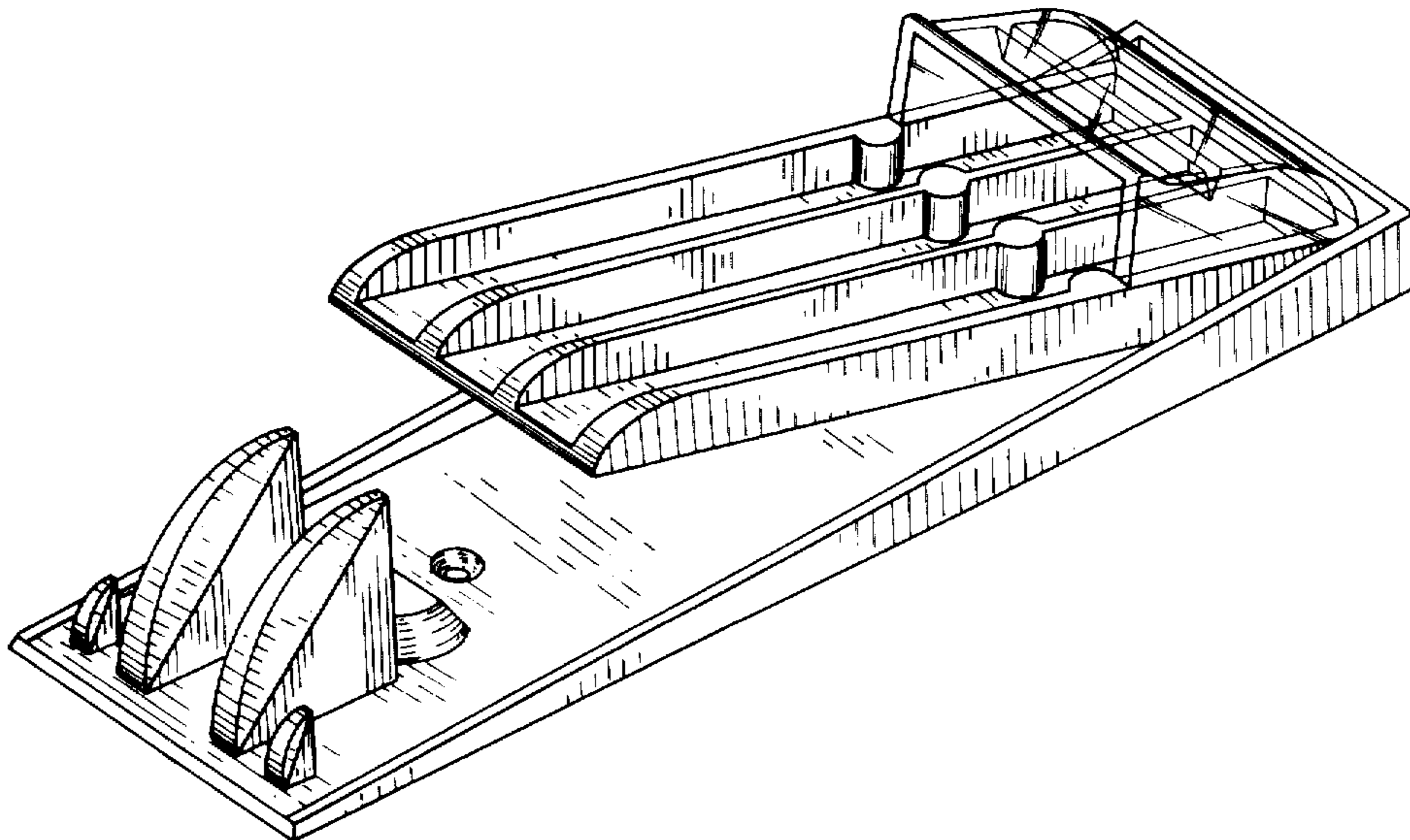

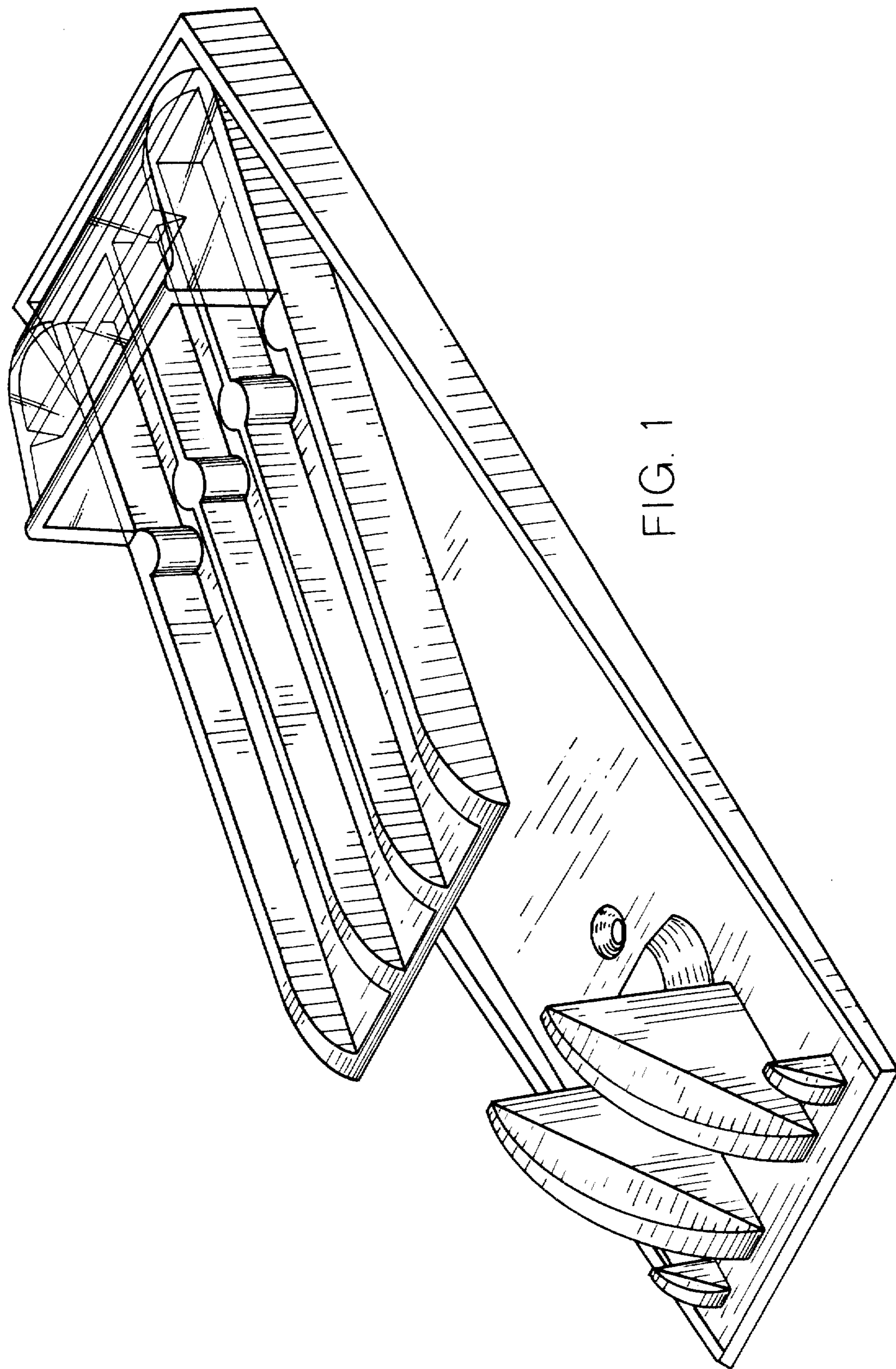

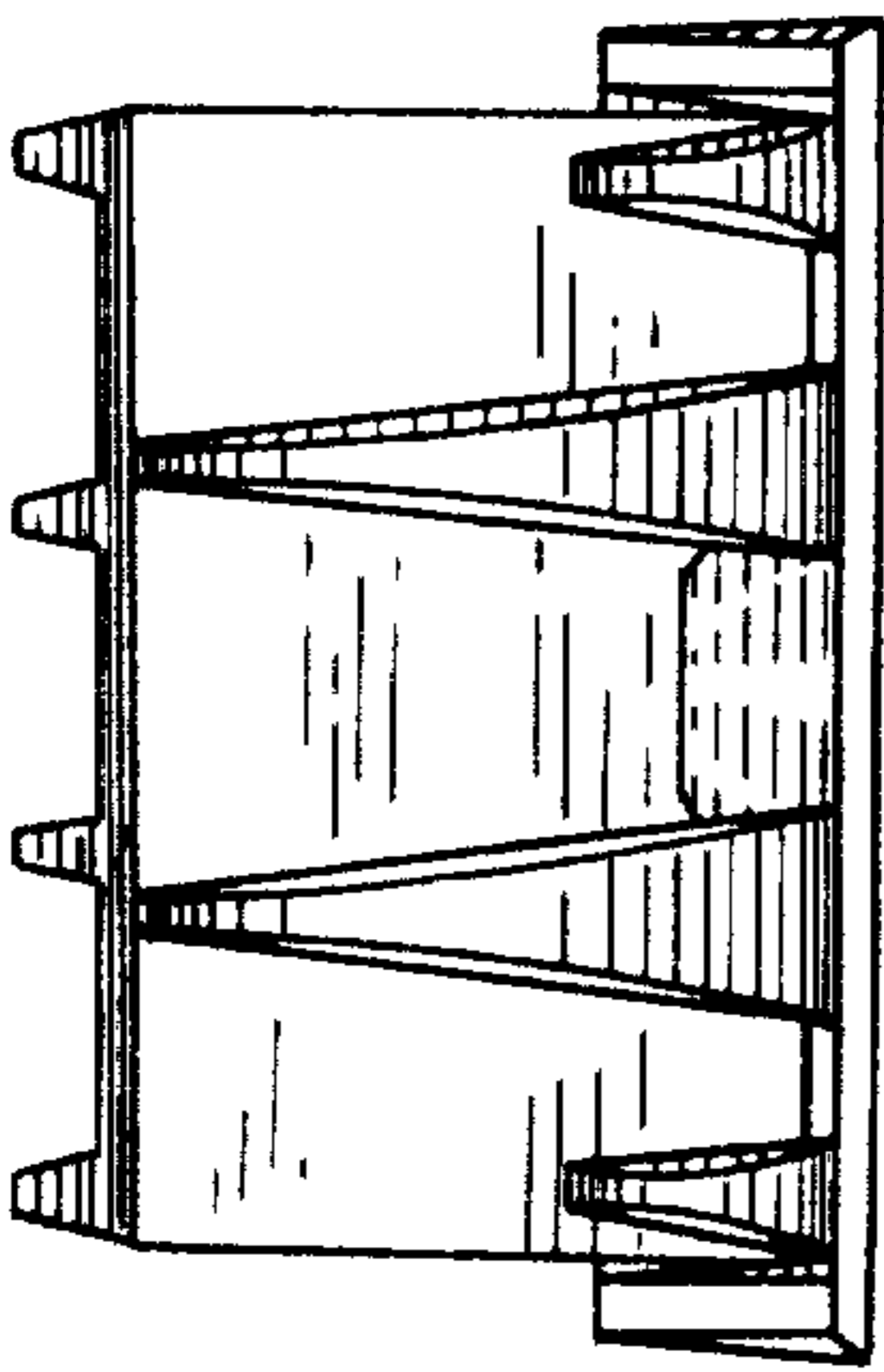

FIG. 2

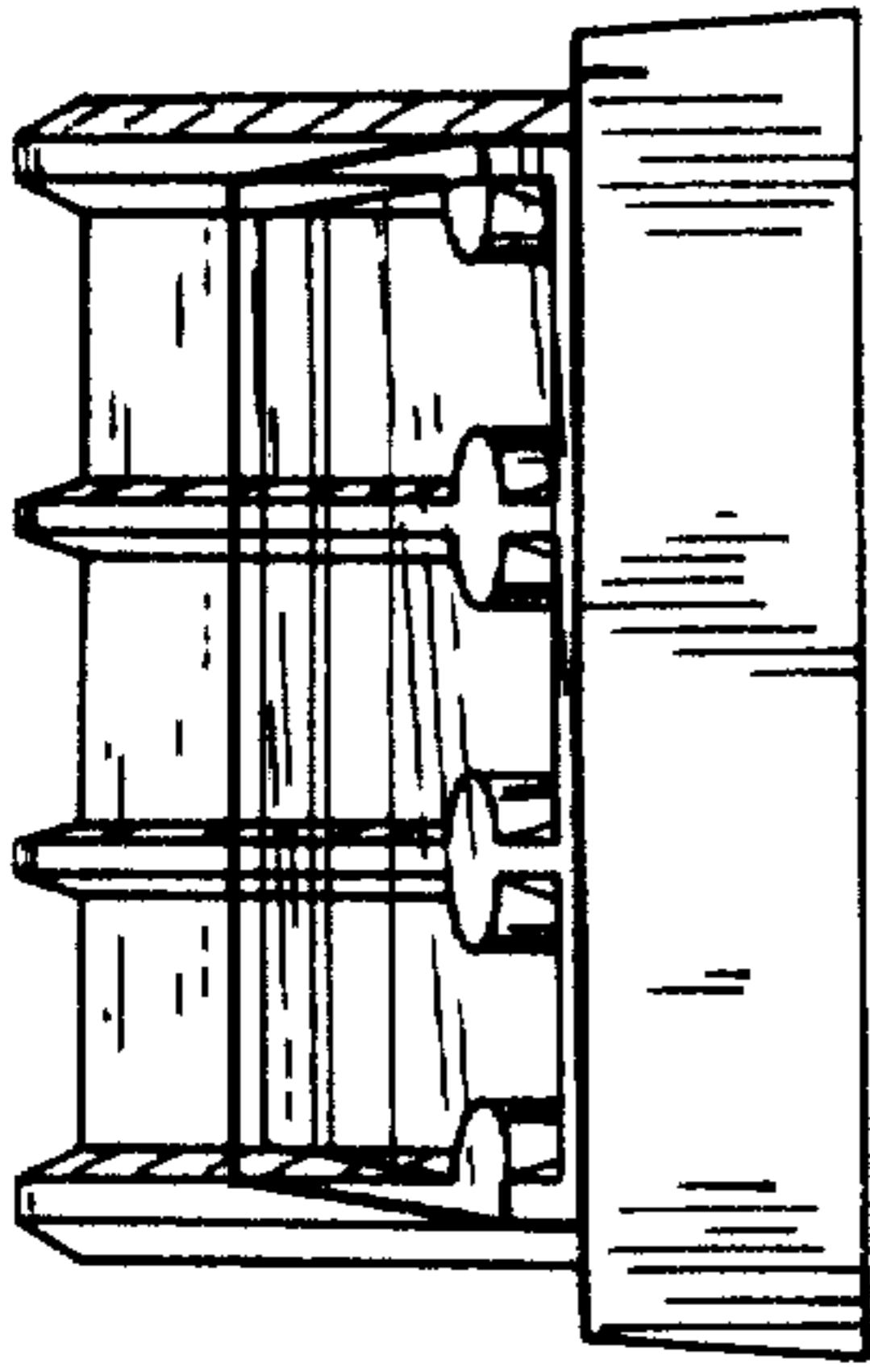

FIG. 3

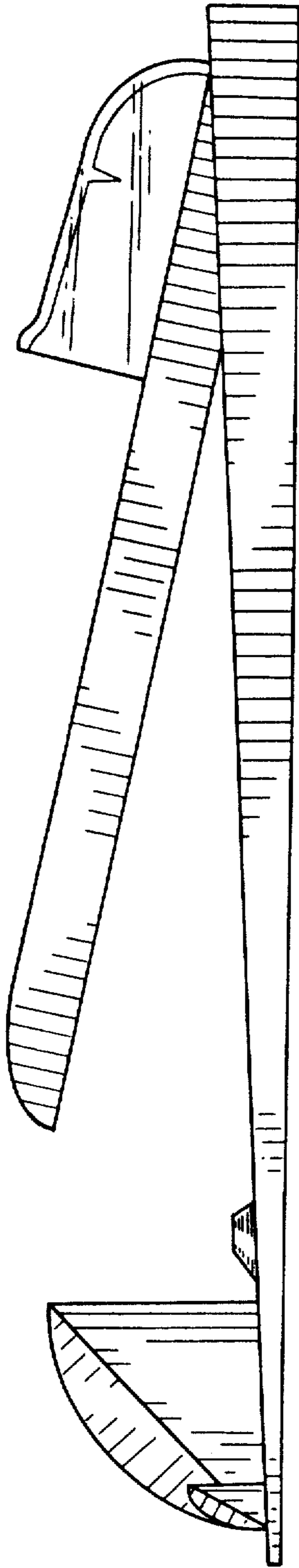

FIG. 4

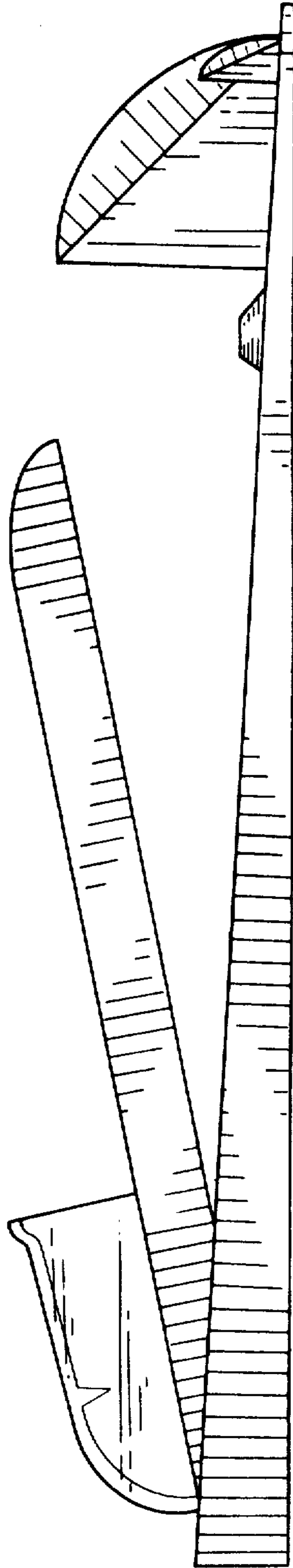

FIG. 5

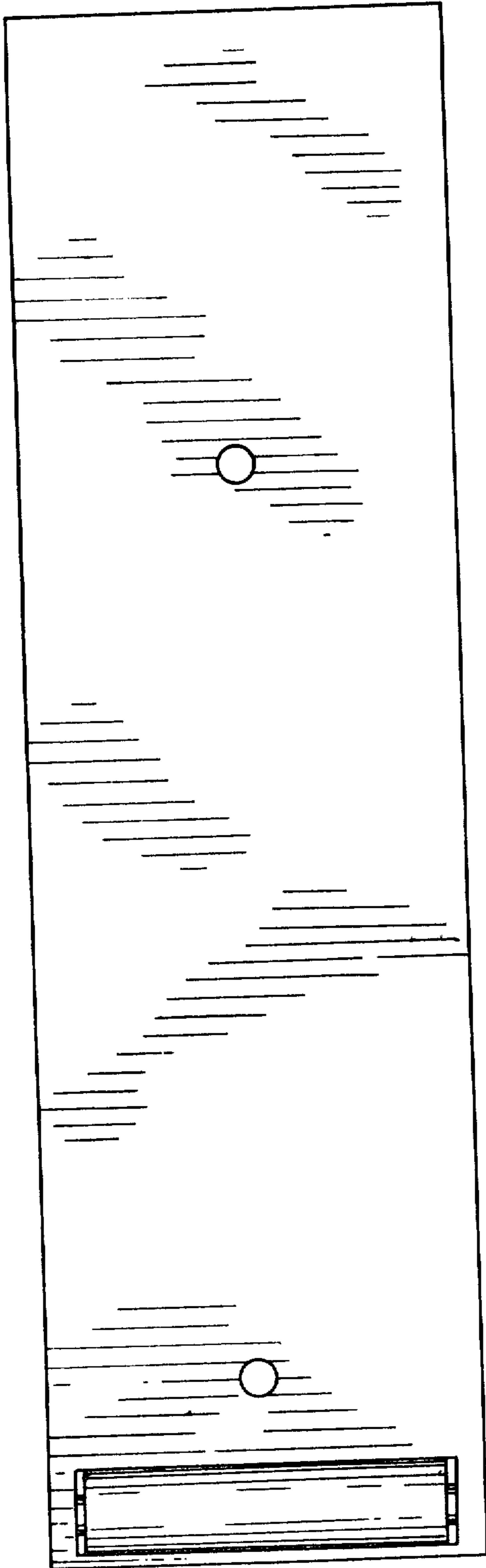

FIG. 6

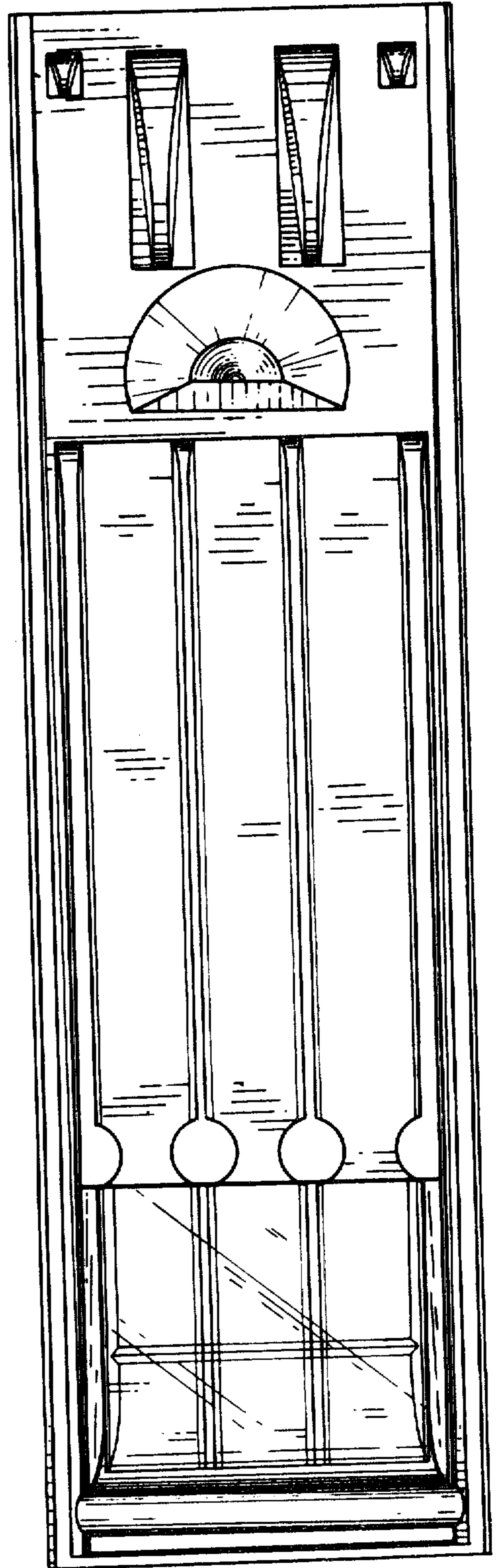

FIG. 7