

[54] DISPENSER FOR CANS OR BOTTLES

2,852,327 9/1958 Mason 211/49 D
3,784,022 1/1974 Beesley, Jr. 312/45 X
4,228,903 10/1980 Eckert 211/49 D

[75] Inventor: William S. Spamer, Roswell, Ga.

[73] Assignee: The Mead Corporation, Dayton, Ohio

[**] Term: 14 Years

[21] Appl. No.: 296,997

[22] Filed: Aug. 27, 1981

[52] U.S. Cl. D6/188

[58] Field of Search D6/85, 188; 211/49 R,
211/49 S, 49 D, 134, 135; 312/45

[56] References Cited

U.S. PATENT DOCUMENTS

D. 119,956 4/1940 Gomez D6/189
D. 211,918 8/1968 Wilder et al. D6/188
2,218,444 10/1940 Vineyard 211/49 D

Primary Examiner—Charles A. Rademaker
Assistant Examiner—Carmen Vales
Attorney, Agent, or Firm—Rodgers & Rodgers

[57] CLAIM

The ornamental design for a dispenser for cans or bottles, as shown and described.

DESCRIPTION

FIG. 1 is a perspective view of a dispenser for cans or bottles showing my new design;
FIG. 2 is a front elevational view thereof;
FIG. 3 is a right side elevational view, the left side being a mirror image thereto;
FIG. 4 is a rear elevational view thereof;
FIG. 5 is a top plan view thereof; and,
FIG. 6 is a bottom plan view thereof.

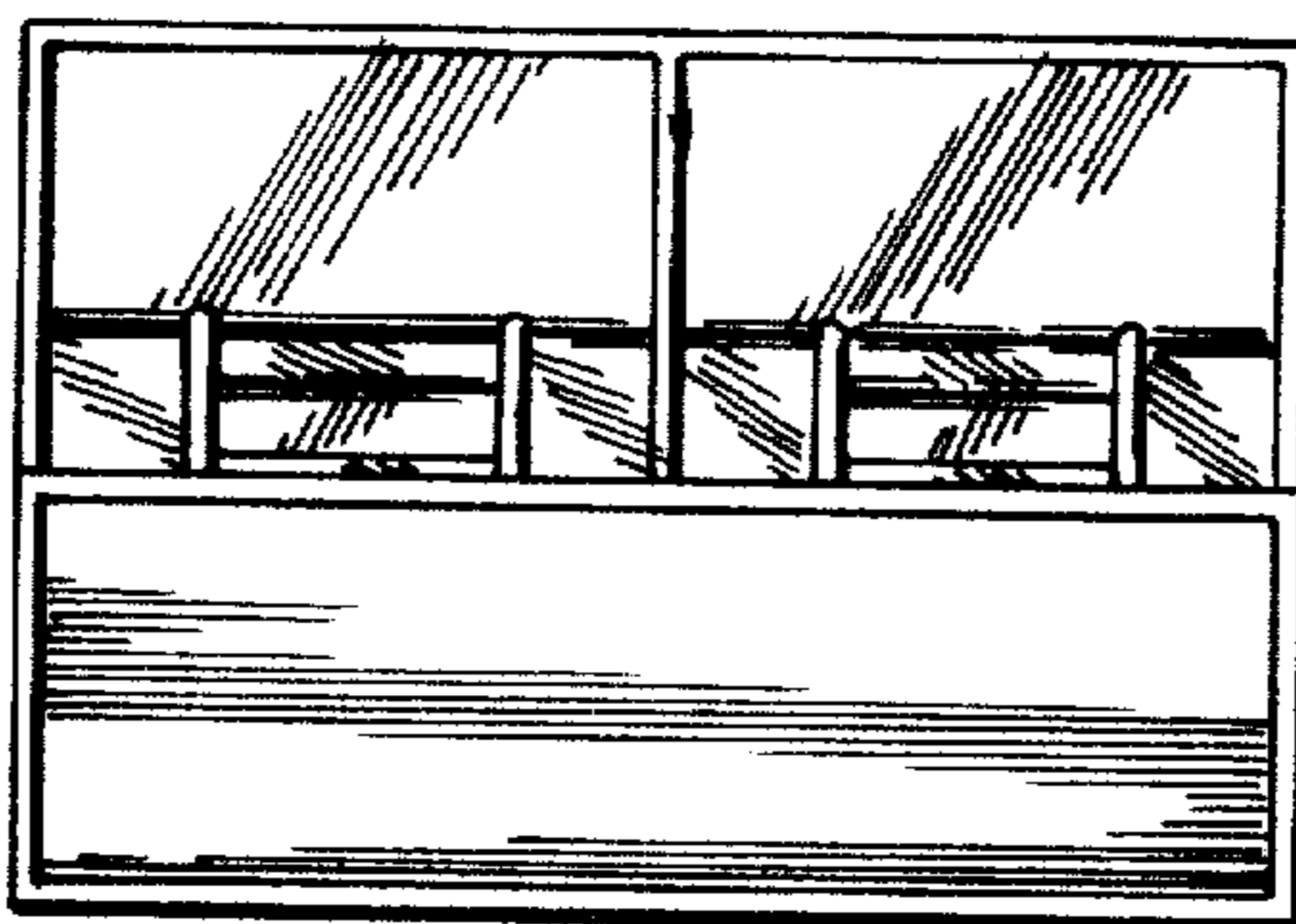

Fig. 1

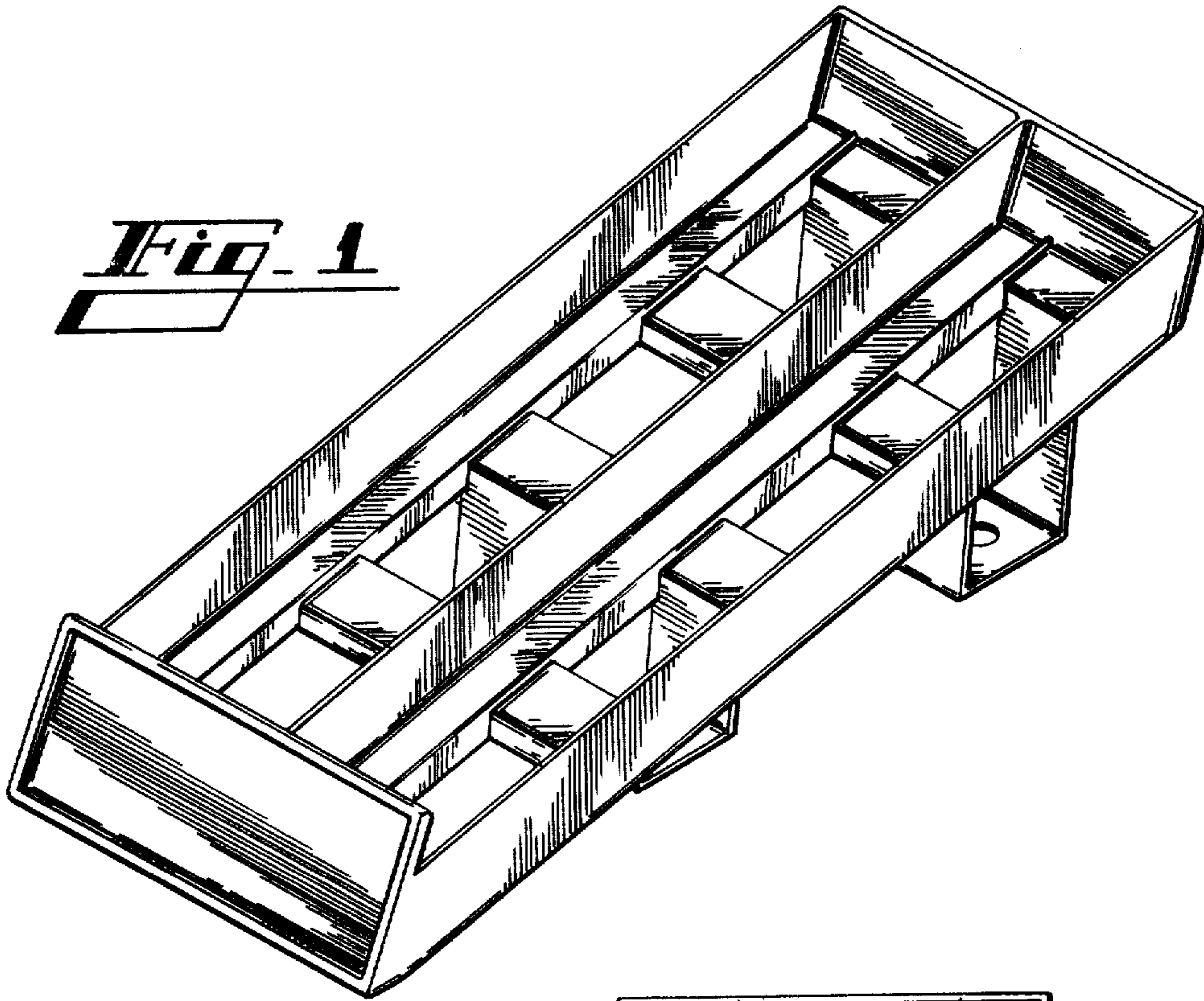

Fig. 2

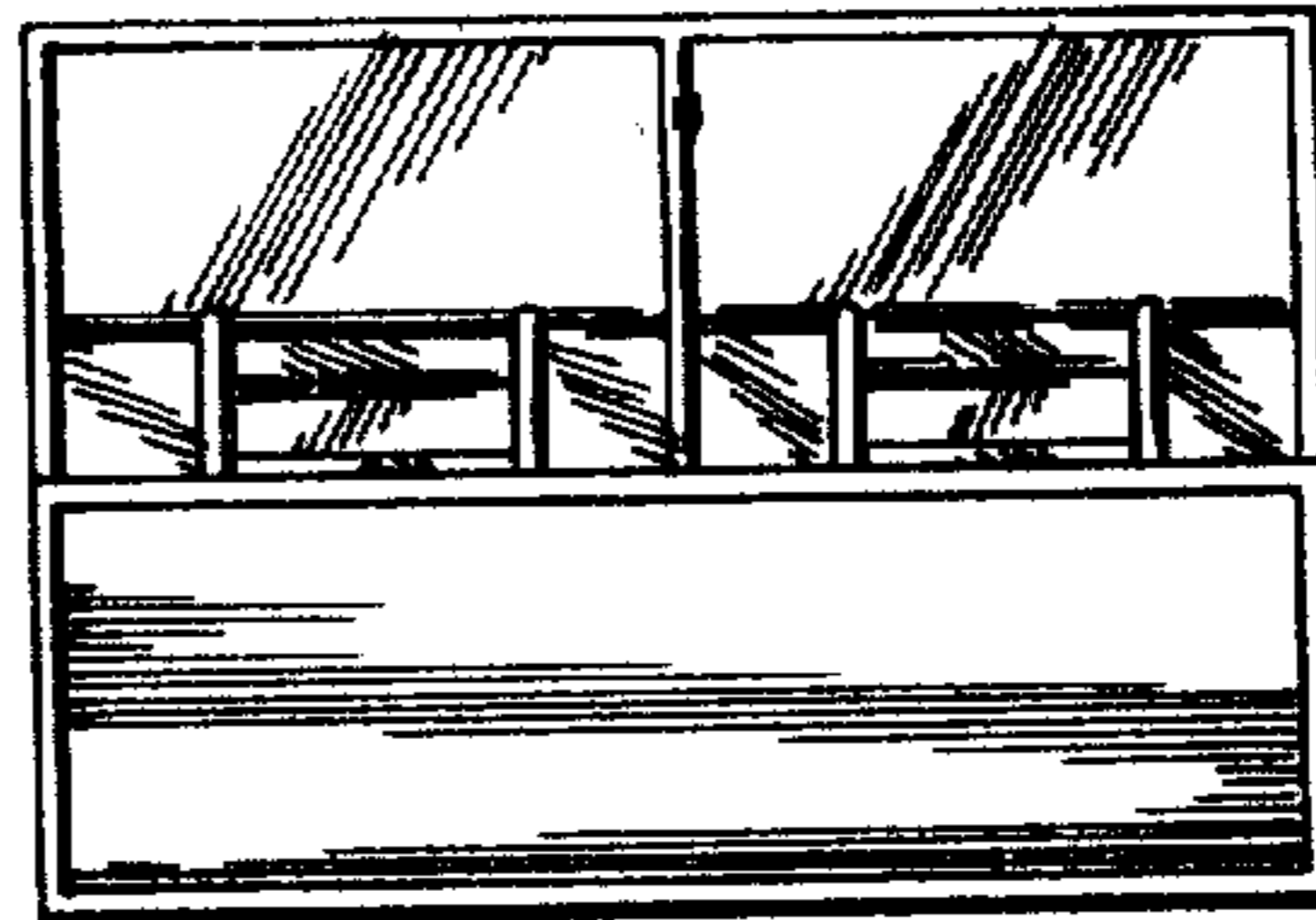

Fig. 3

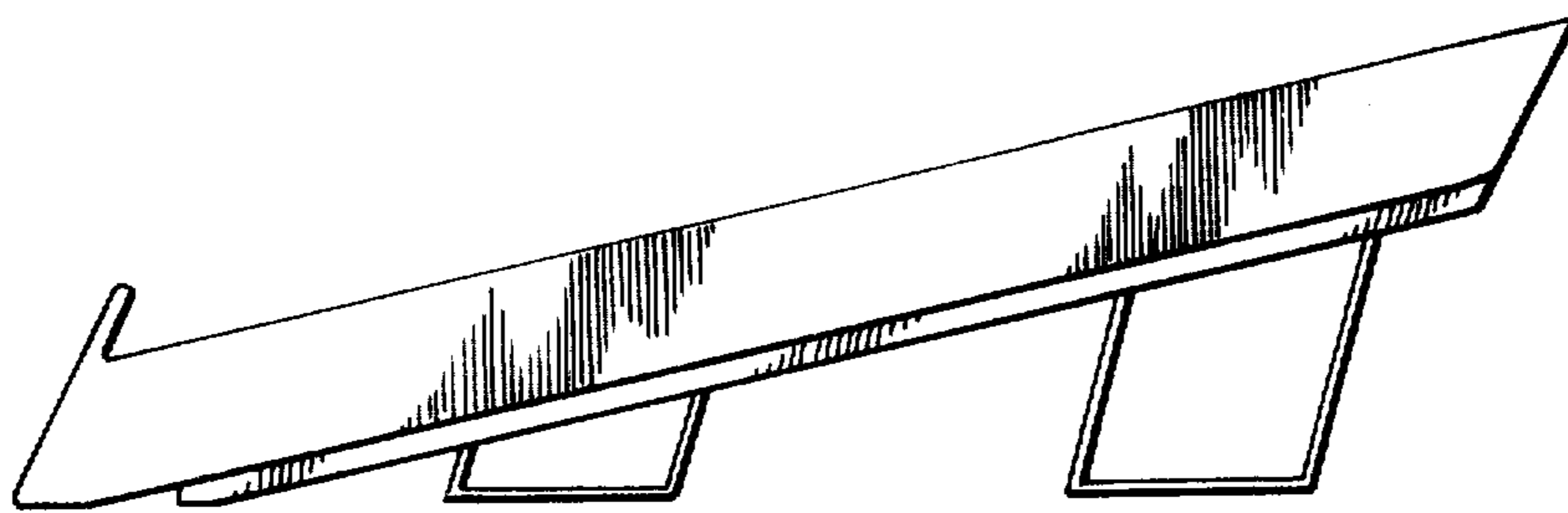

Fig. 4

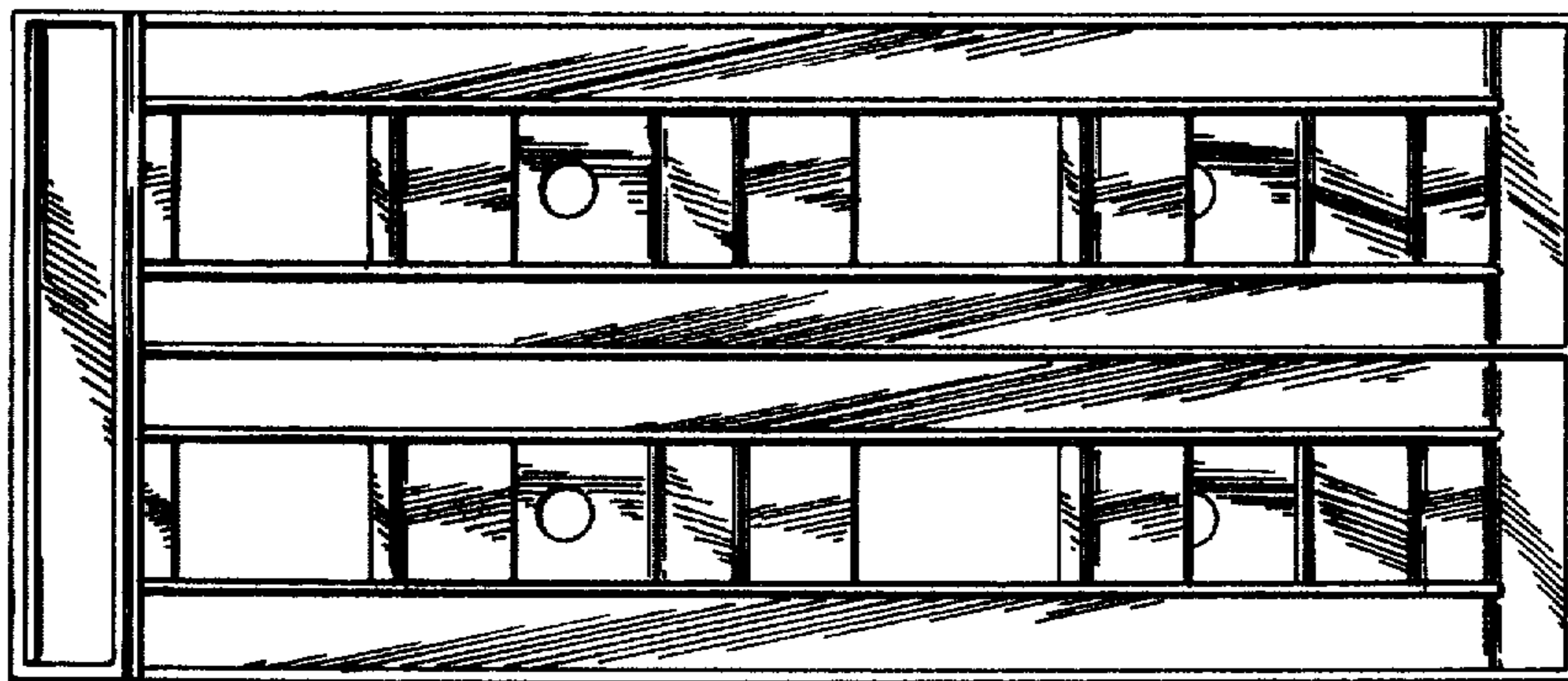
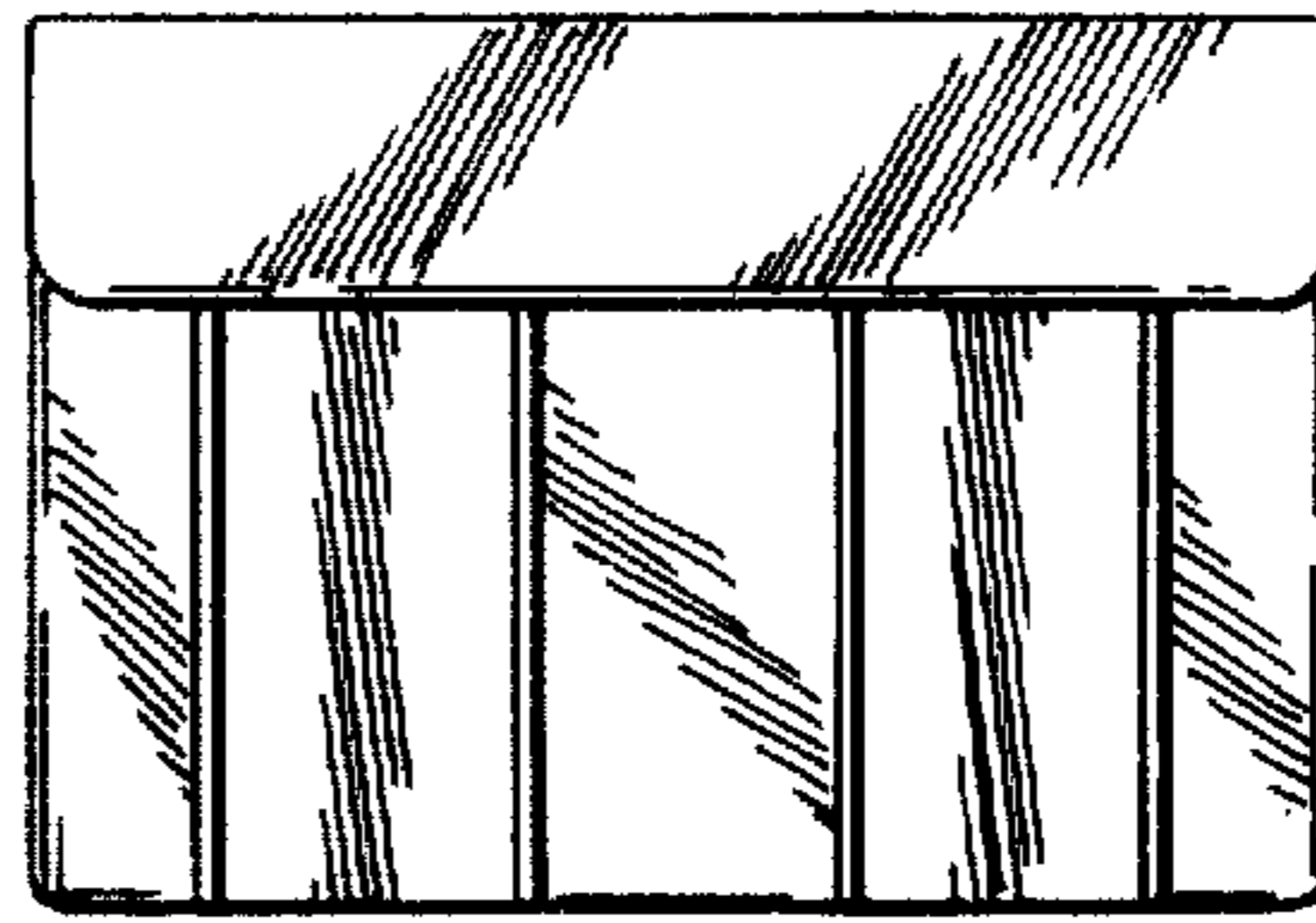

Fig. 5

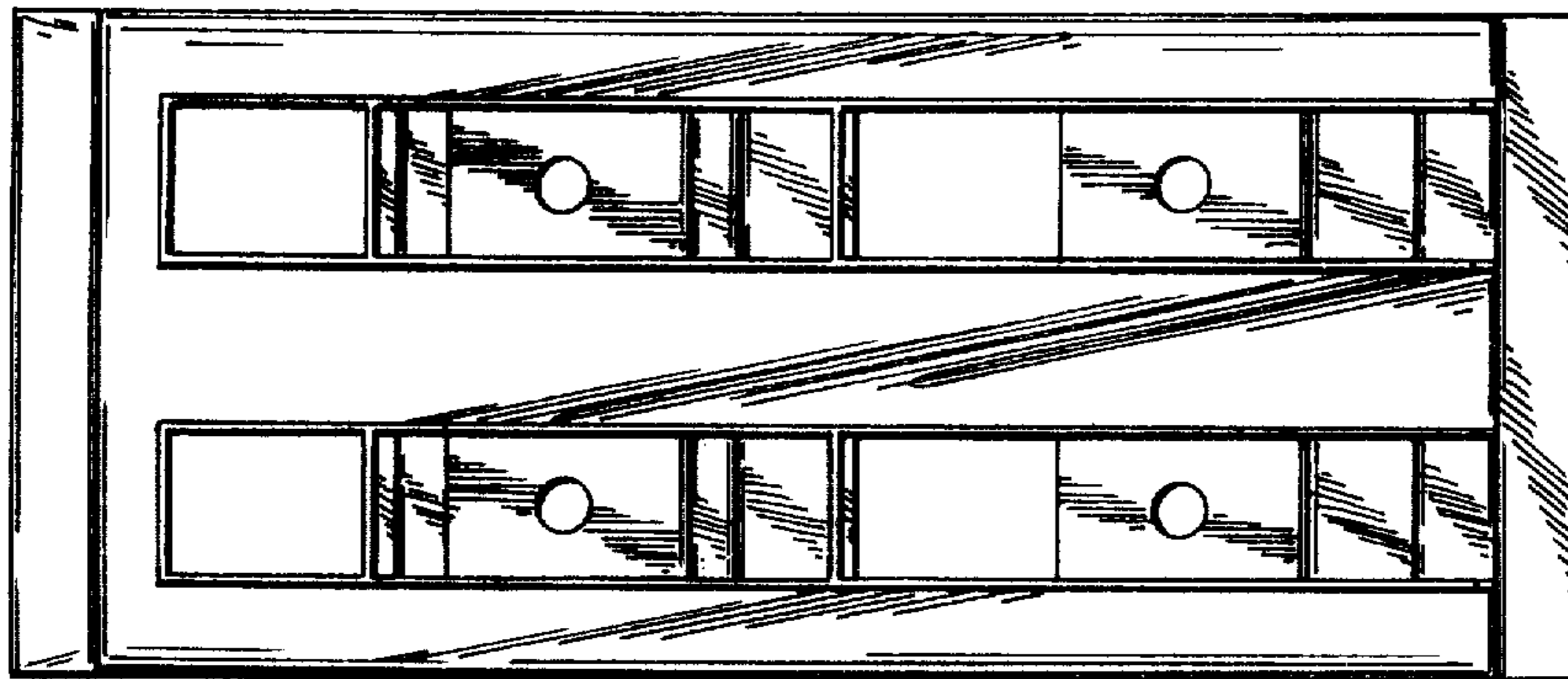

Fig. 6