

[54] **CHILD'S SECURITY SEAT FOR VEHICLES**

[75] Inventor: **Leif Hallgren, Hyltebruck, Sweden**

[73] Assignee: **Hallgrens Industri AB, Hyltebruk, Sweden**

[**] Term: **14 Years**

[21] Appl. No.: **336,573**

[22] Filed: **Jan. 4, 1982**

[51] Int. Cl. **D6-01**

[52] U.S. Cl. **D6/9**

[58] Field of Search **D6/7, 8, 9, 47;**
D297/274, 276, 277, 243

[56] **References Cited**

U.S. PATENT DOCUMENTS

- D. 212,215 9/1968 Brilmyer et al. **D6/9**
D. 231,589 5/1974 Bloom **D6/9**

- D. 262,242 12/1981 Molnar **D6/9**
D. 267,599 1/1983 Fator **D6/9 X**

Primary Examiner—**Bruce W. Dunkins**

[57] **CLAIM**

The ornamental design for a child's security seat for vehicles, as shown and described.

DESCRIPTION

FIG. 1 is a perspective view taken from the top, front and left side of a child's security seat for vehicles according to my new design;

FIG. 2 is a perspective view taken from the bottom, rear and right side thereof;

FIG. 3 is a rear end elevational view thereof;

FIG. 4 is a front elevational view thereof;

FIG. 5 is a left side elevational view thereof;

FIG. 6 is a right side elevational view thereof;

FIG. 7 is a top plan view thereof; and,

FIG. 8 is a bottom plan view thereof.

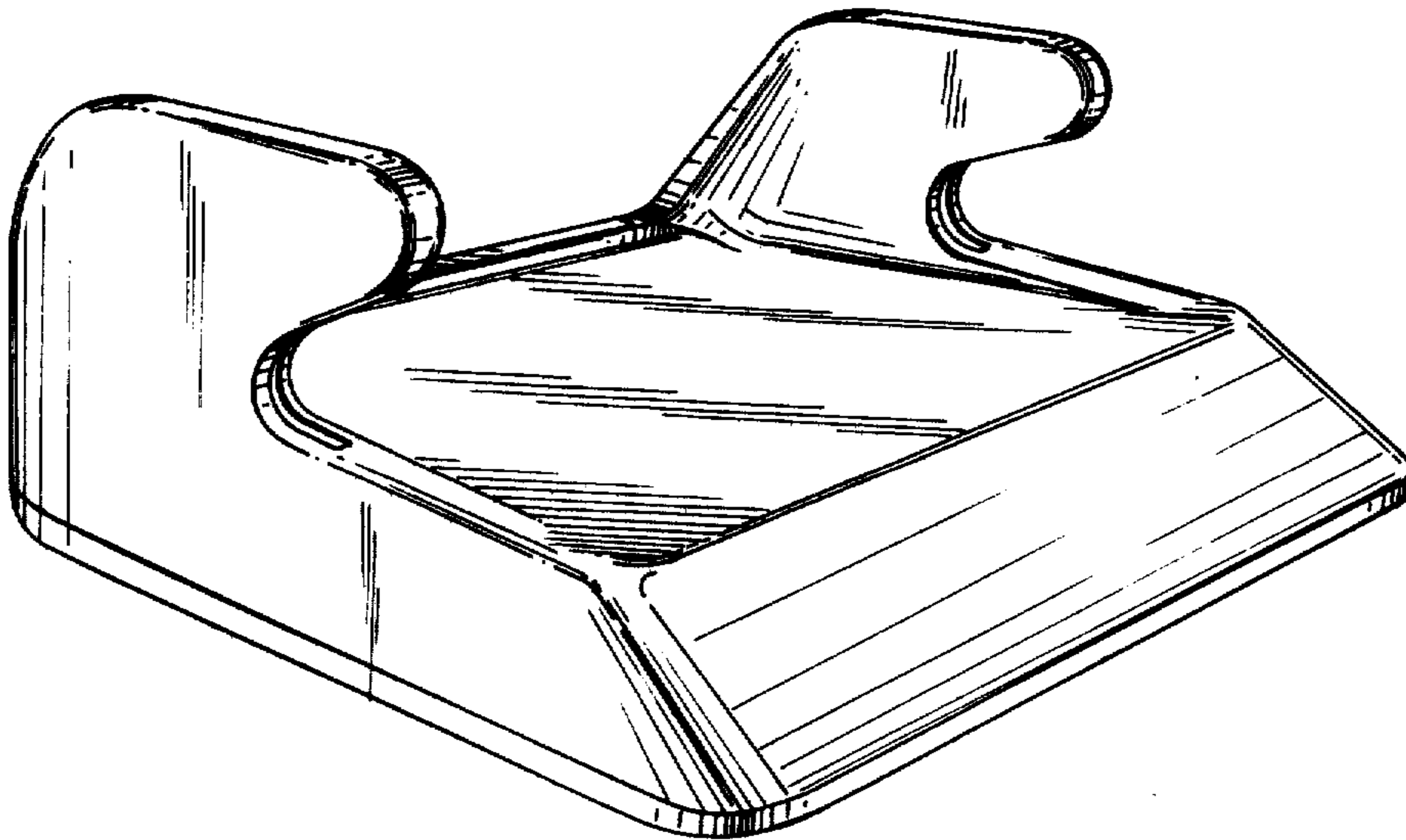

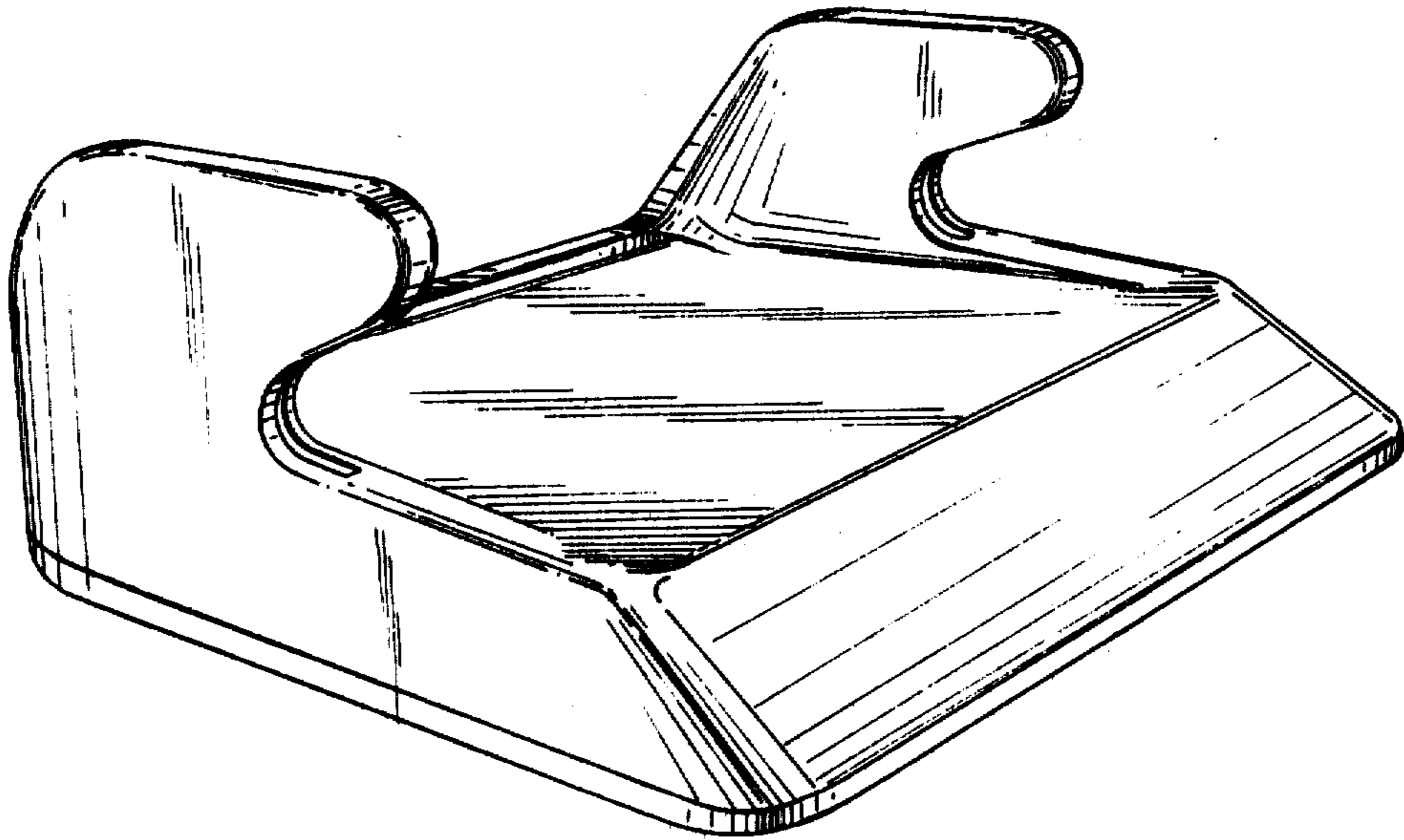

FIG. 1

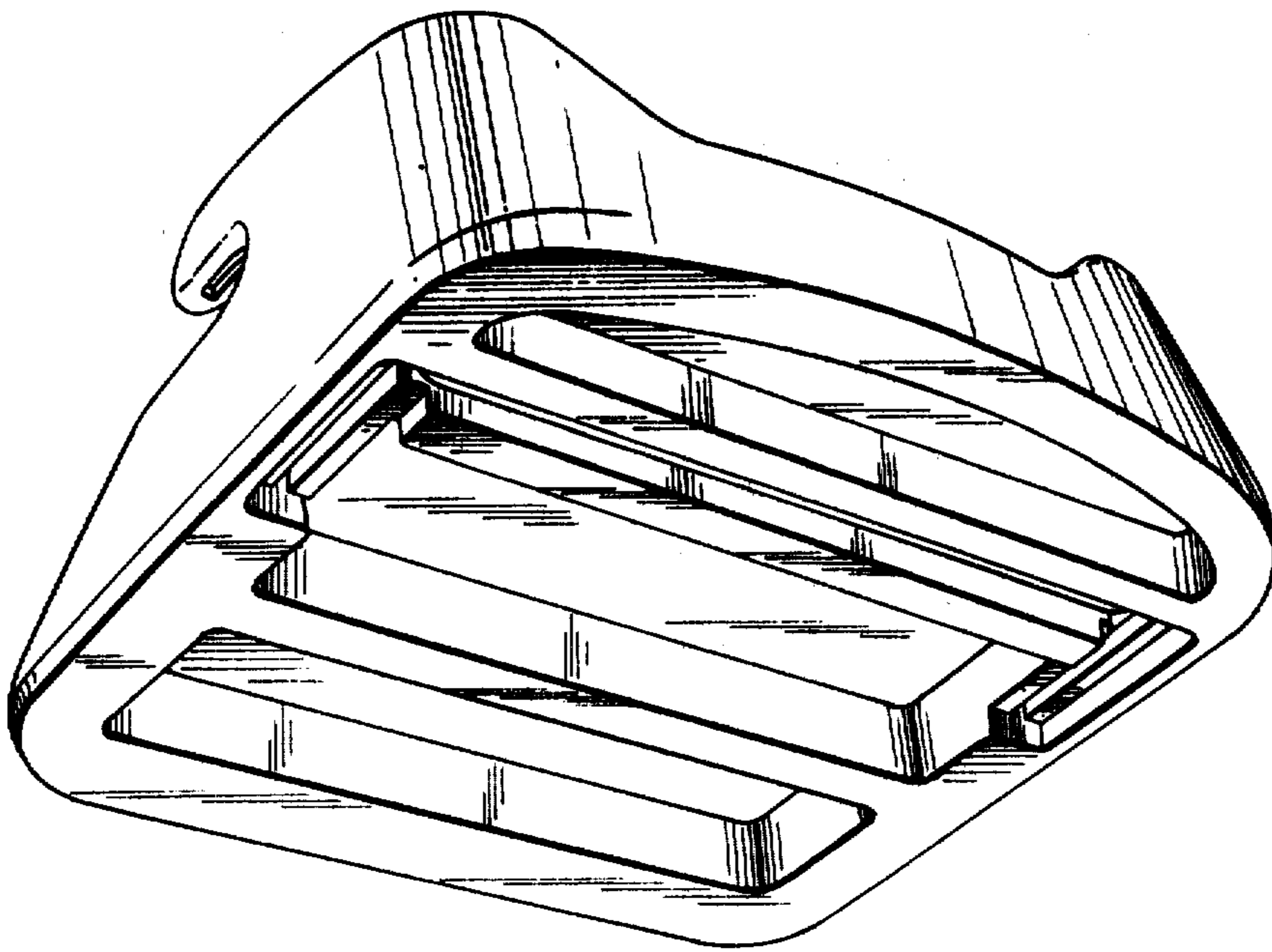

FIG. 2

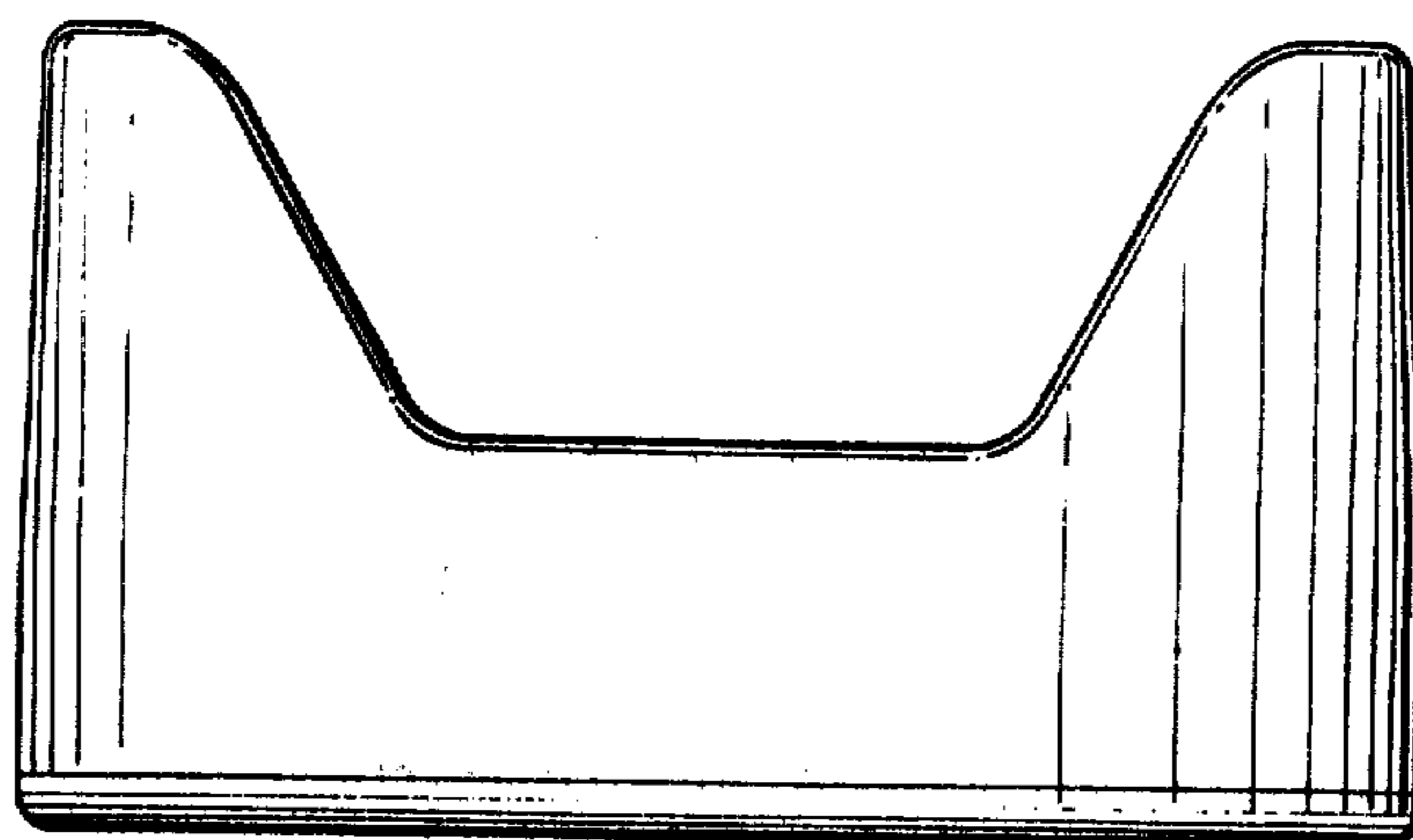

FIG. 3

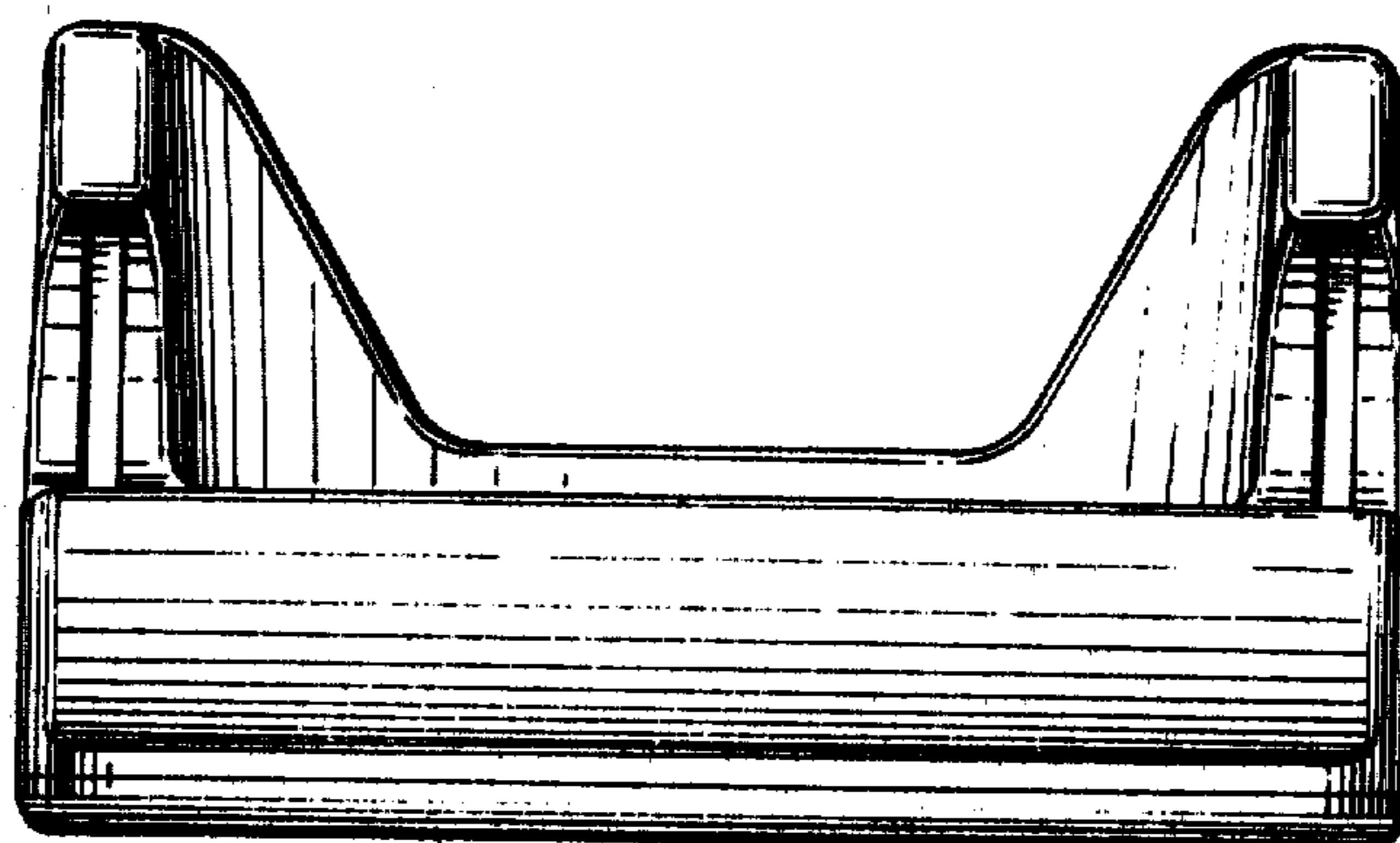

FIG. 4

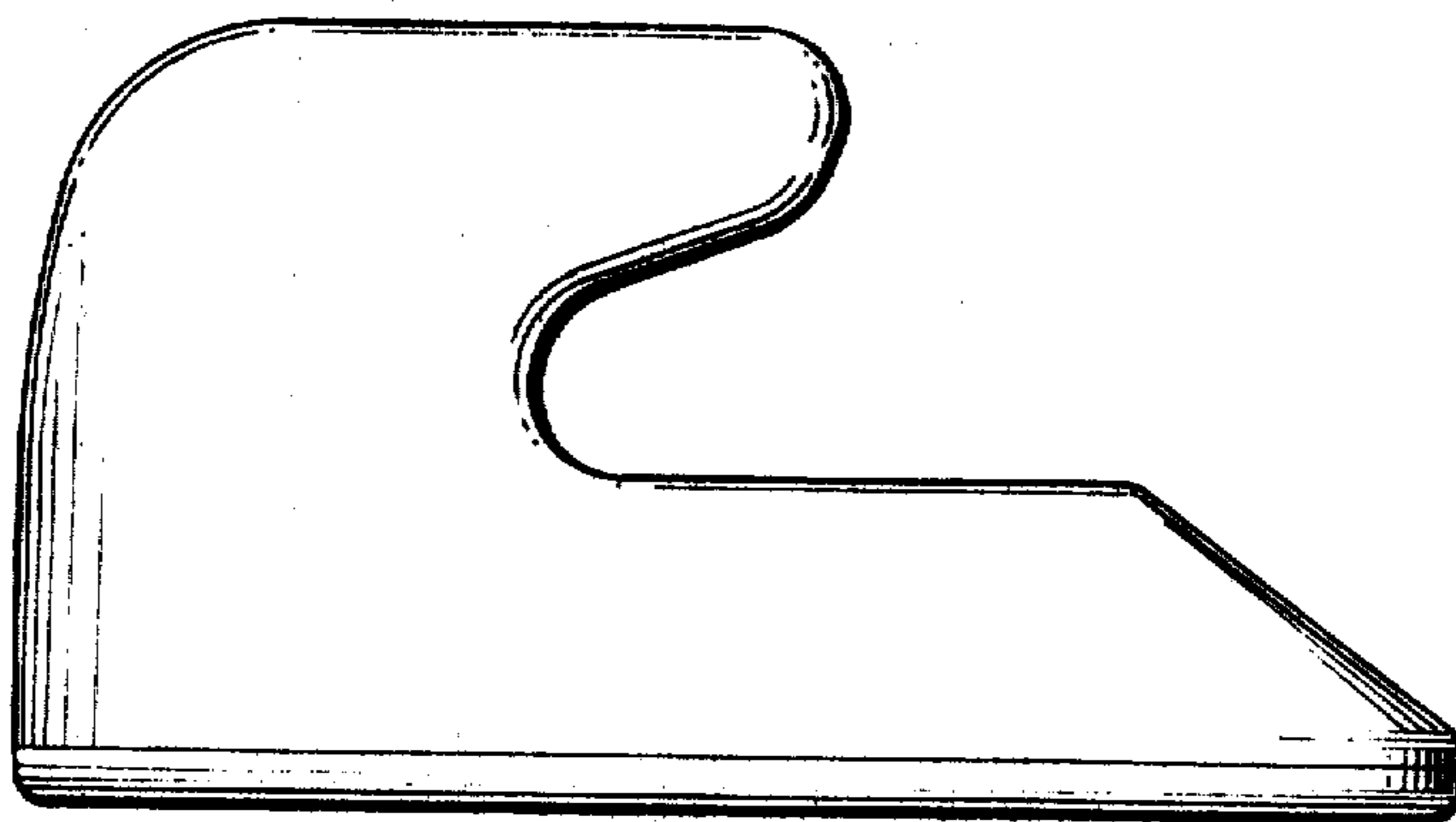

FIG. 5

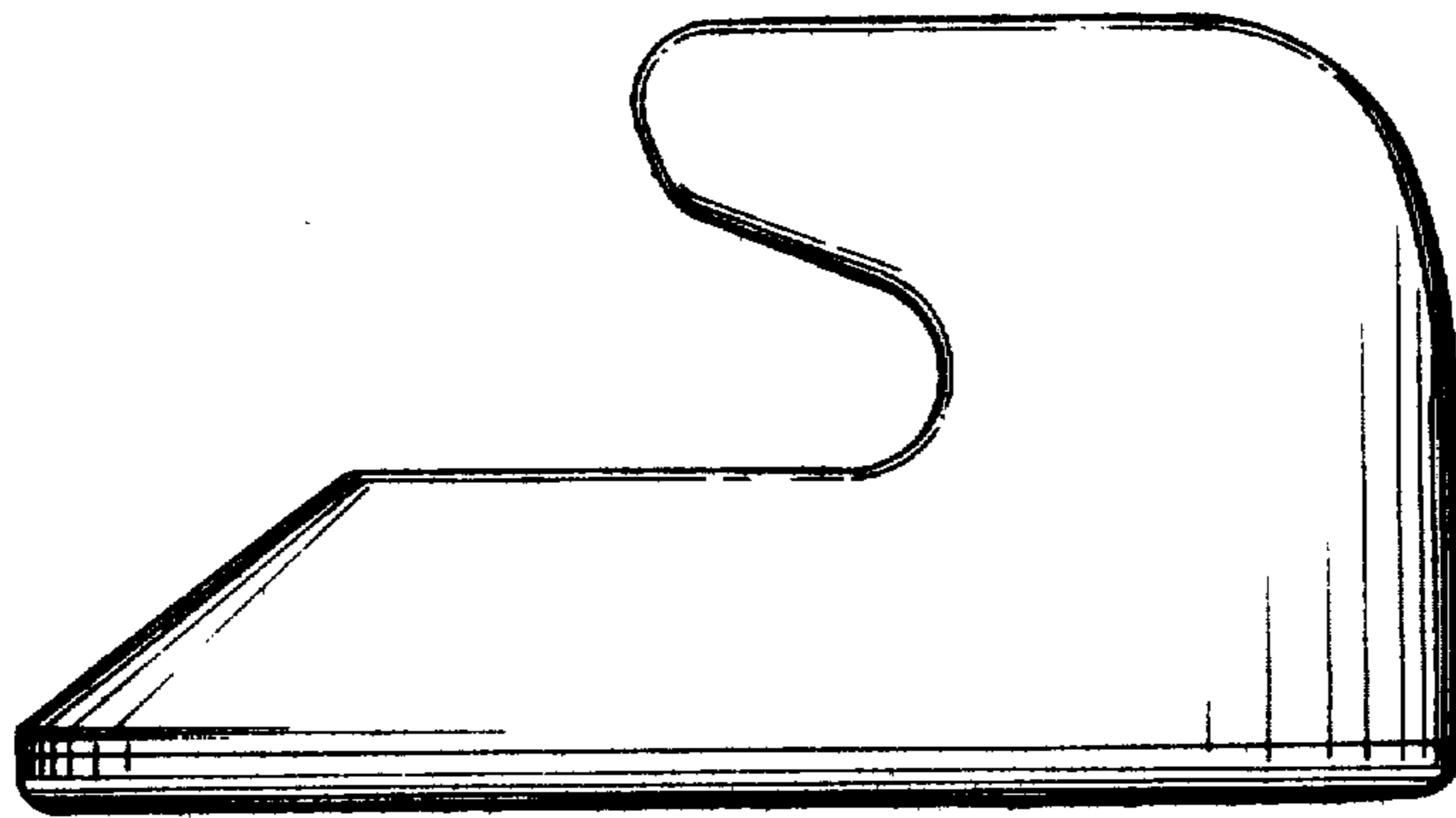

FIG. 6

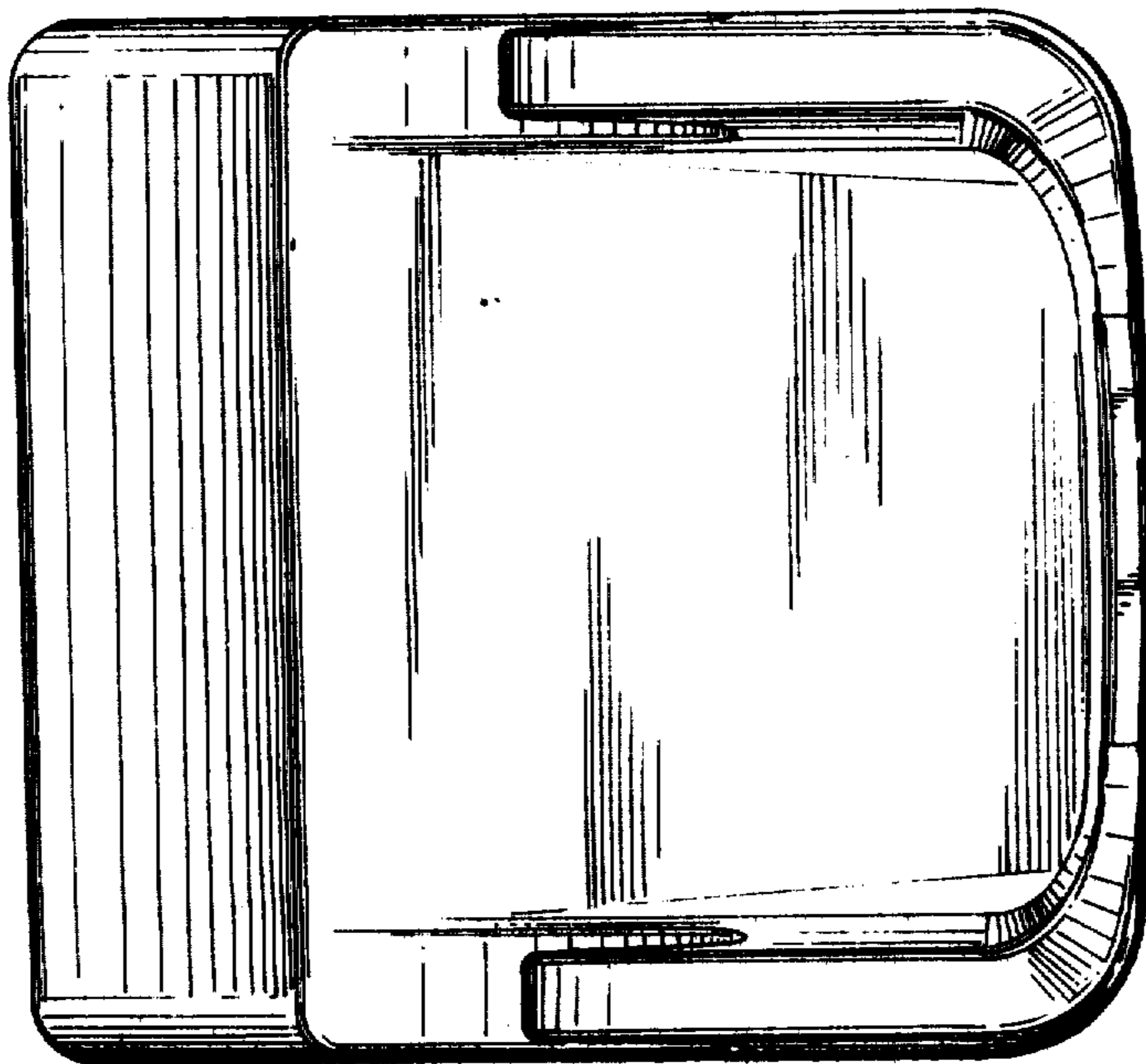

FIG. 7

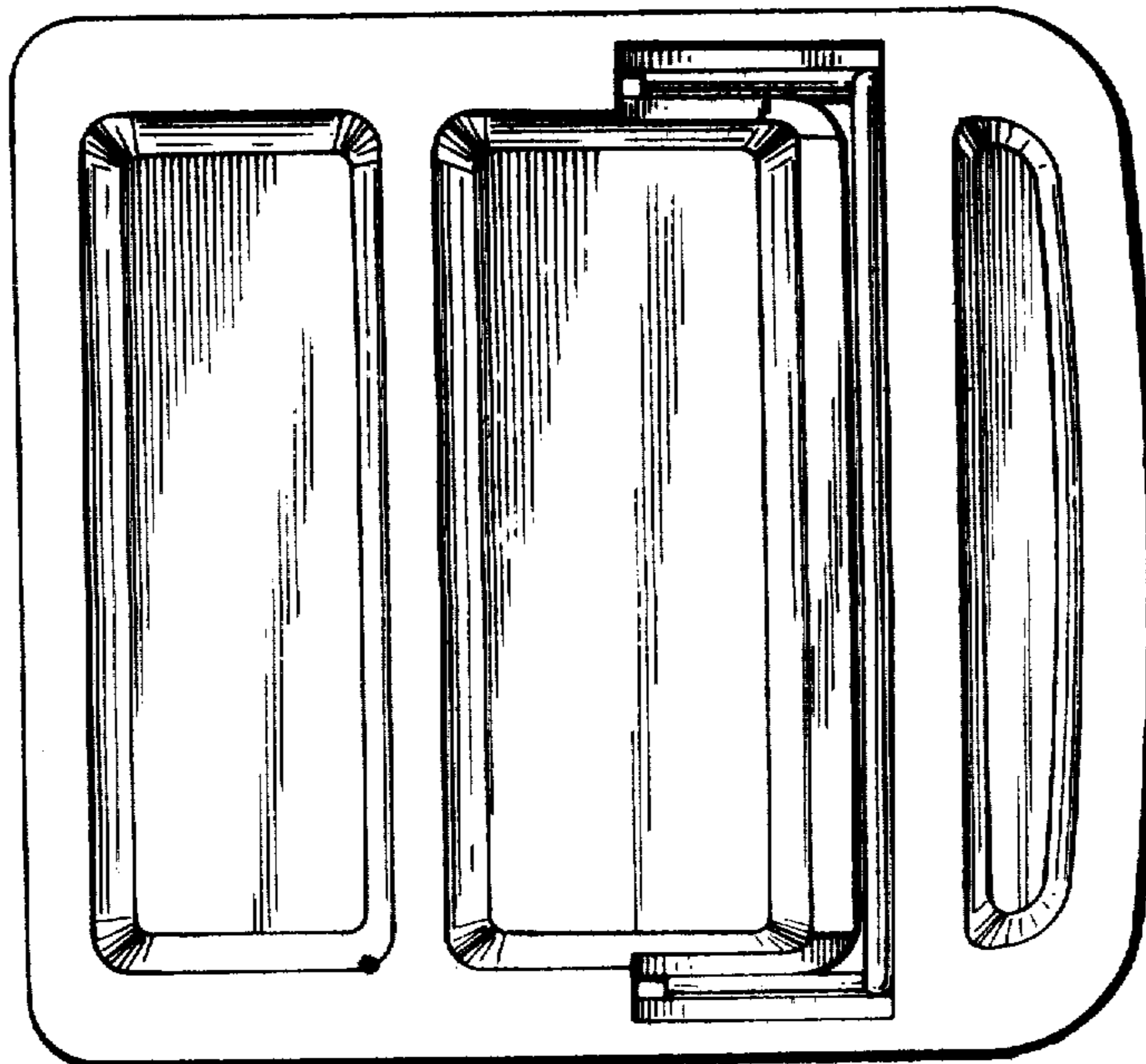

FIG. 8