

[54] **SHELVING SYSTEM FOR CANS OR THE LIKE**

4,270,661 6/1981 Rosenband ..... 211/49 D  
4,356,923 11/1982 Young et al. .... 211/49 D

[76] Inventors: **Leroy Ray**, 5840 S. National; **Frank D. Dickey**, 850 W. Highland, both of, Springfield, Mo. 65807

[\*\*] Term: **14 Years**

[21] Appl. No.: **275,842**

[22] Filed: **Jun. 22, 1981**

[51] Int. Cl. .... **D06-04**

[52] U.S. Cl. .... **D6/190; D6/186; D6/188; D6/189**

[58] Field of Search ..... **D6/85, 181, 186, 188, D6/189, 157, 190; 211/49 D, 74; 312/45, 72; D7/71**

[56] **References Cited**

**U.S. PATENT DOCUMENTS**

D. 222,151 10/1971 **Majewski** ..... **D6/190**  
D. 242,011 10/1976 **Robertson, Jr.** ..... **D7/71 X**  
3,784,022 1/1974 **Beesley, Jr.** ..... **211/49 D**

**OTHER PUBLICATIONS**

*Modern Plastics* Dec. 1961 p. 193; "Molded Wine Rack" bottom right of page.  
*Gourmet* Apr. 1973 p. 67; Wine Rack on page.

*Primary Examiner*—Joel Stearman  
*Assistant Examiner*—Carmen H. Vales  
*Attorney, Agent, or Firm*—Polster, Polster & Lucchesi

[57] **CLAIM**

The ornamental design for shelving system for cans or the like, as shown and described.

**DESCRIPTION**

FIG. 1 is a perspective view of a shelving system for cans or the like showing our new design;  
FIG. 2 is a right side elevational view thereof;  
FIG. 3 is a left side elevational view thereof;  
FIG. 4 is a top plan view thereof;  
FIG. 5 is a bottom plan view thereof;  
FIG. 6 is a front elevational view, the rear view being similar thereto.

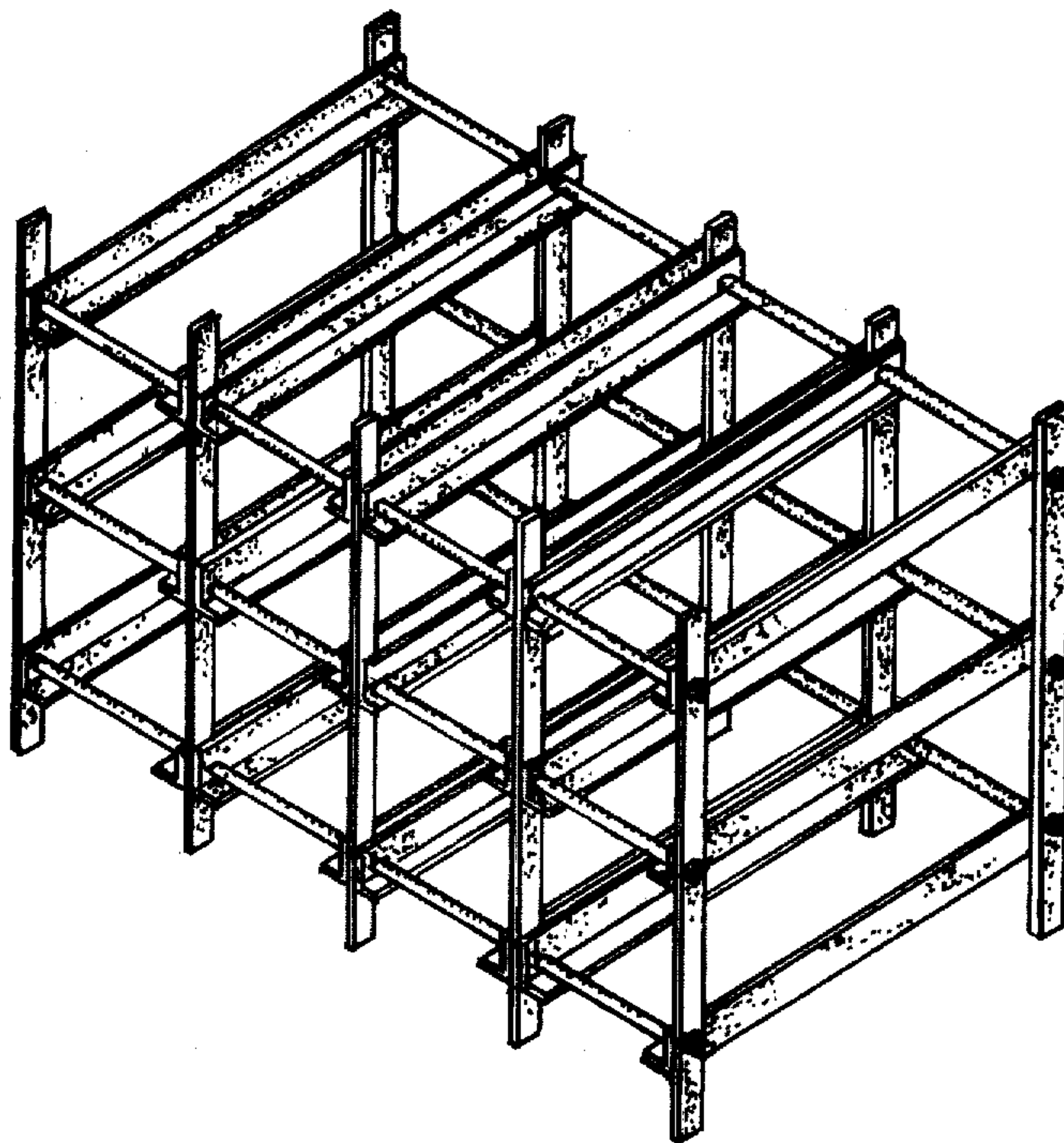

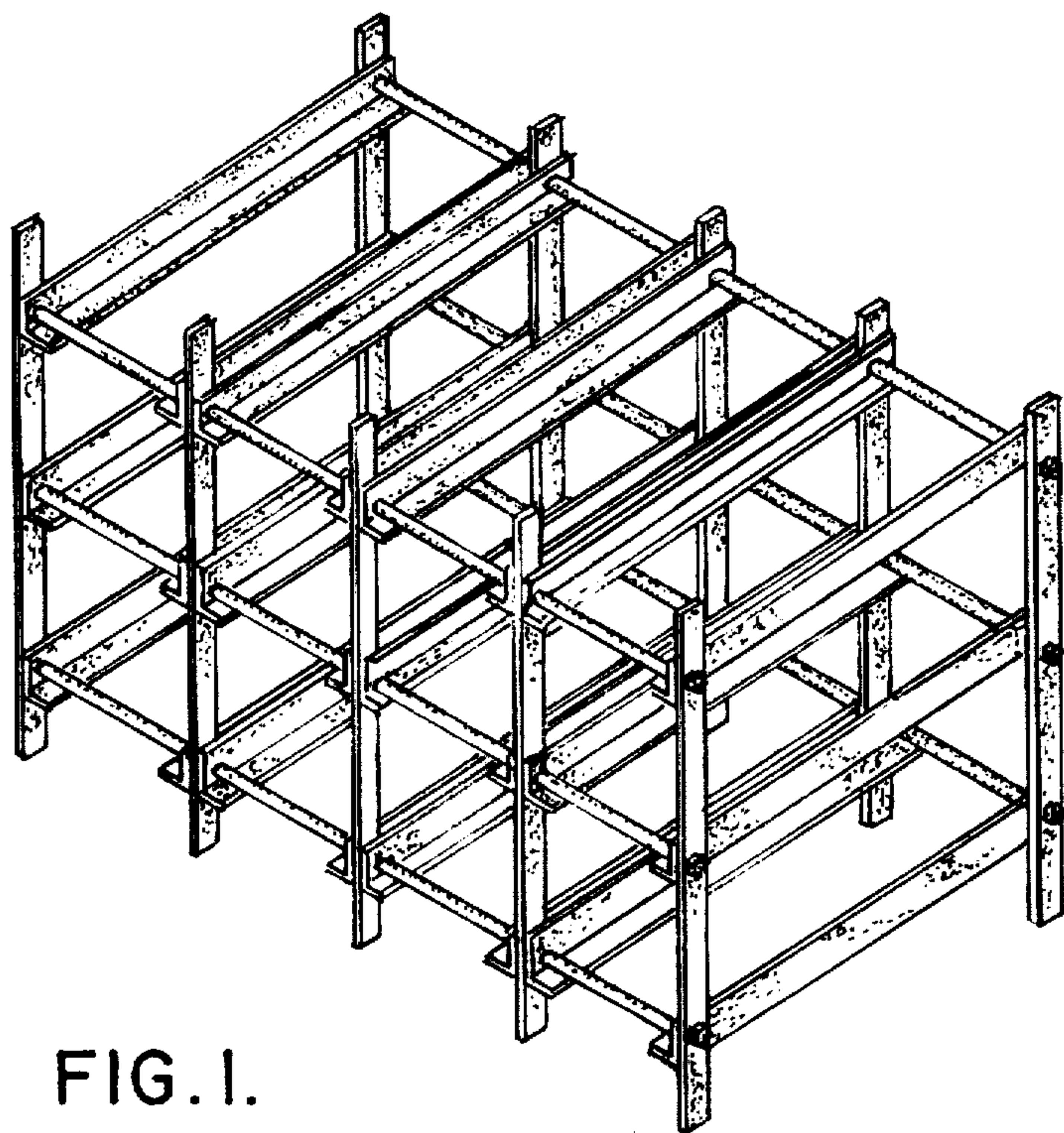

FIG. 1.

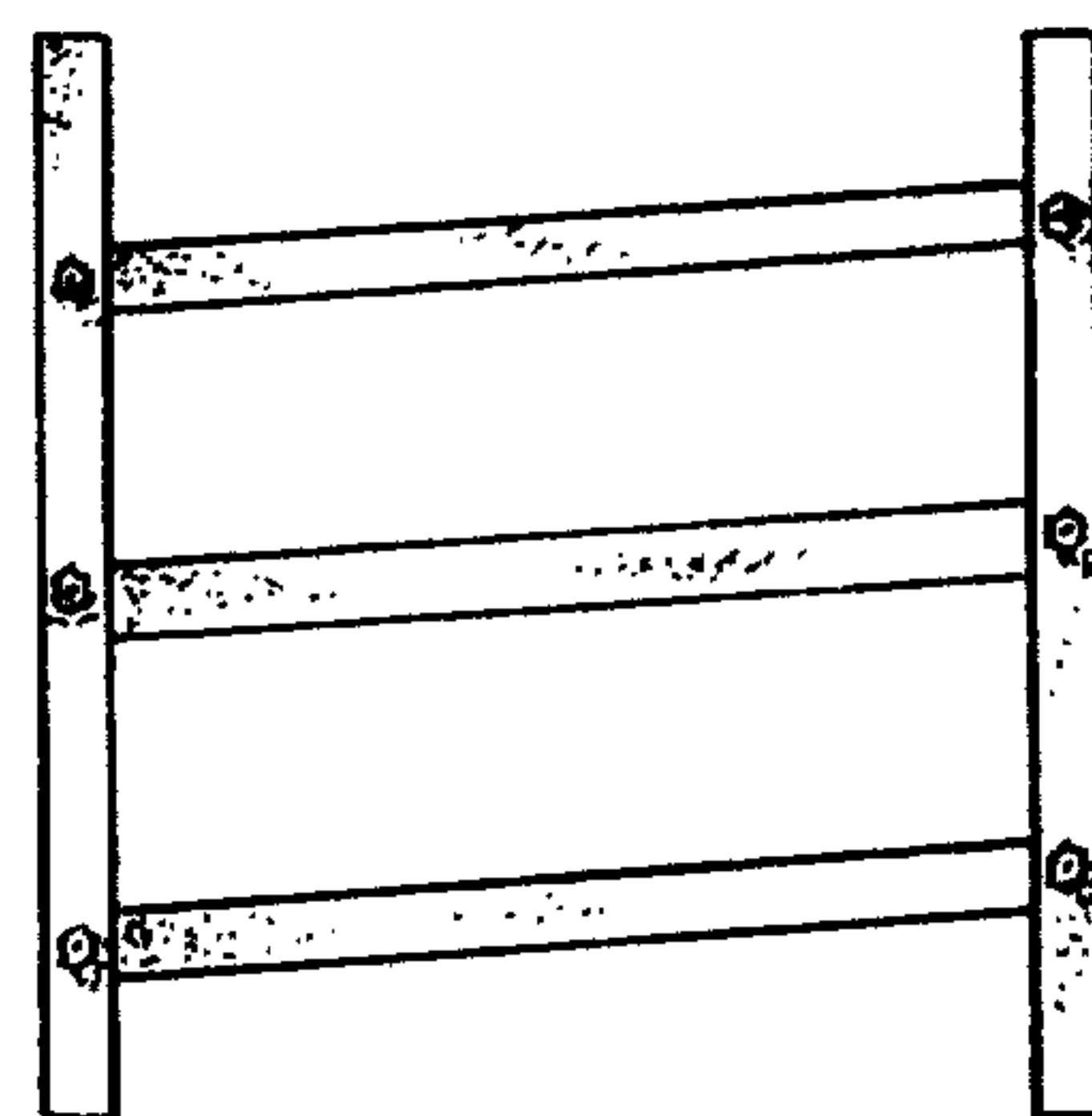

FIG. 2.

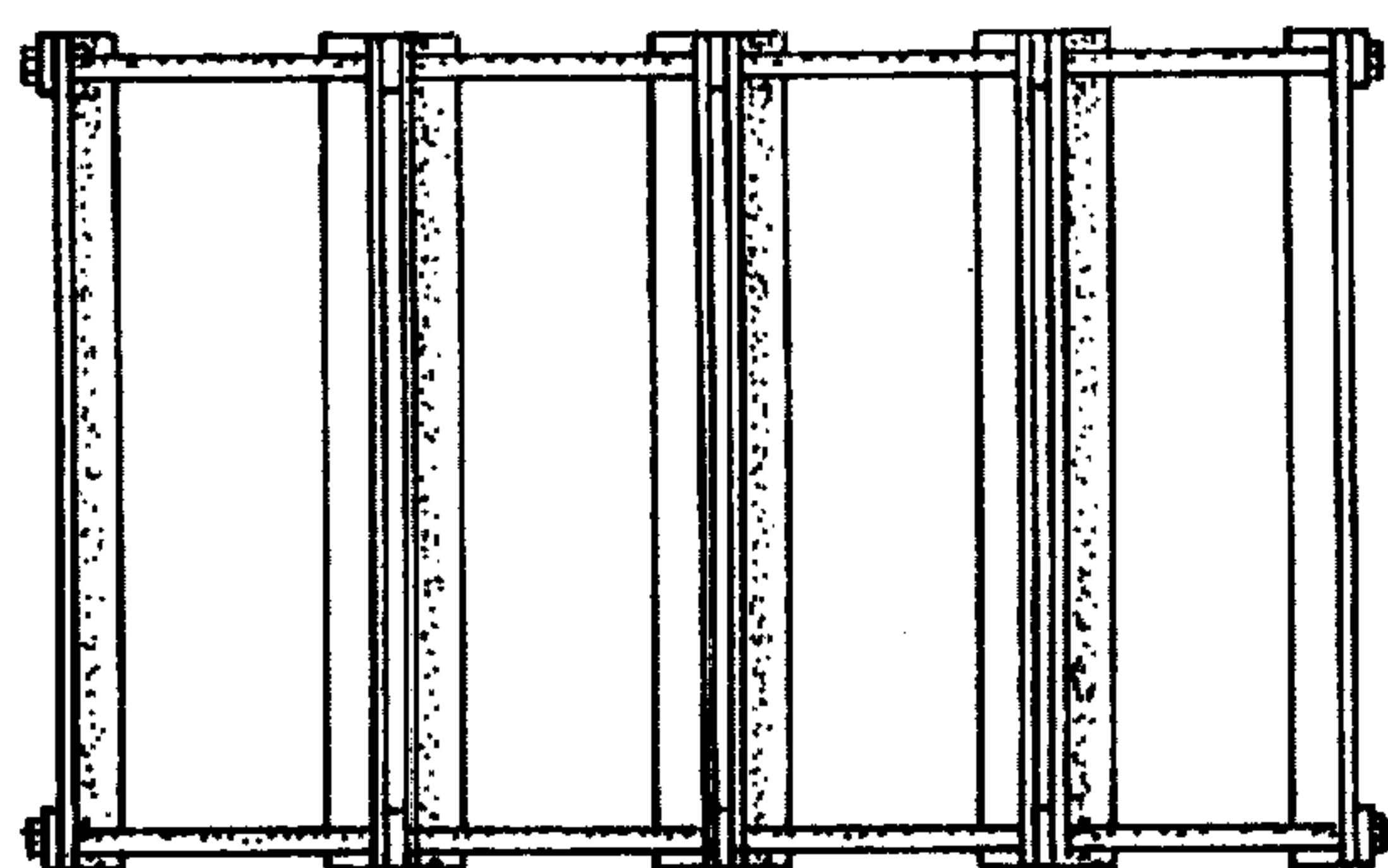

FIG. 4.

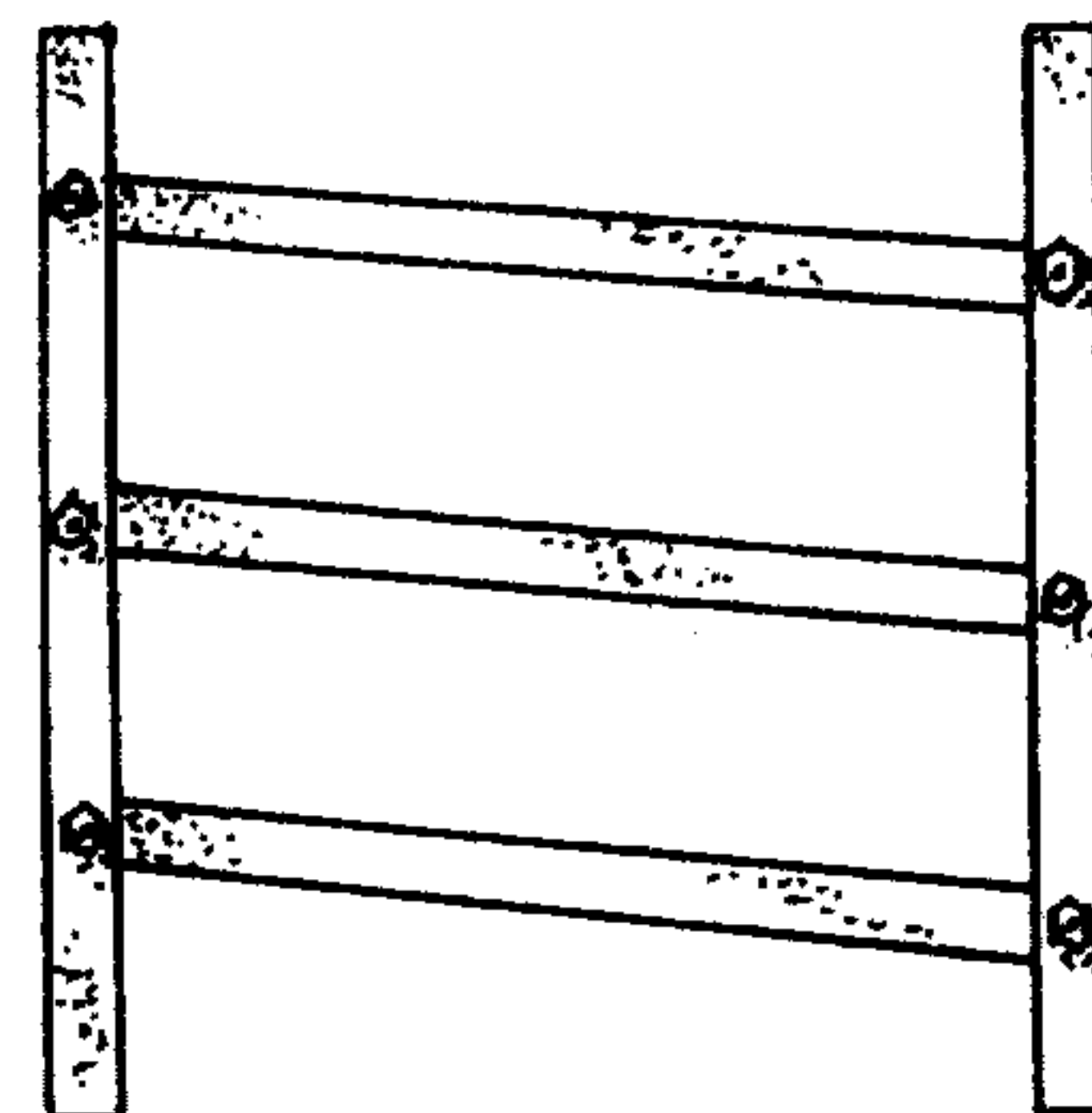

FIG. 3.

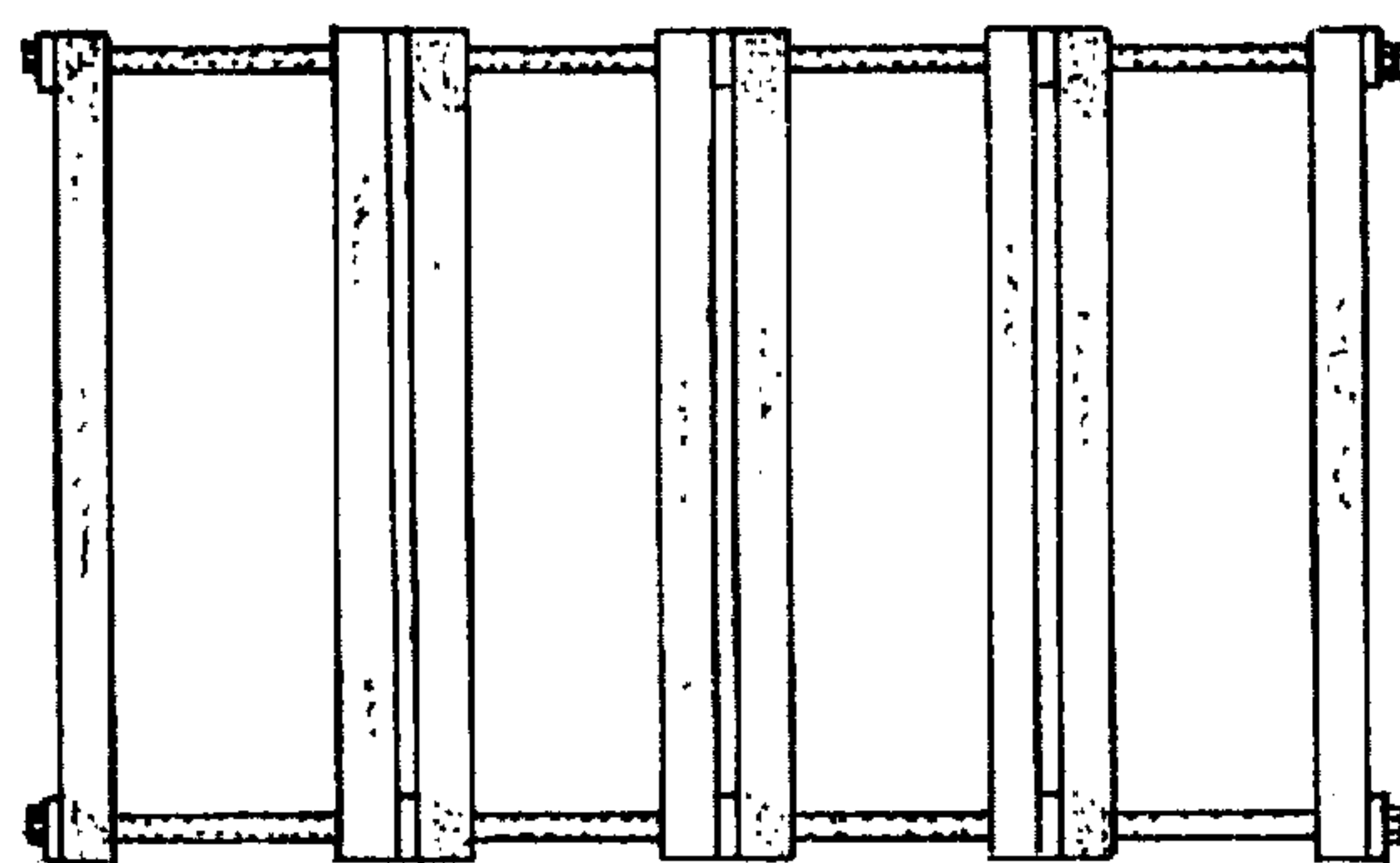

FIG. 5.

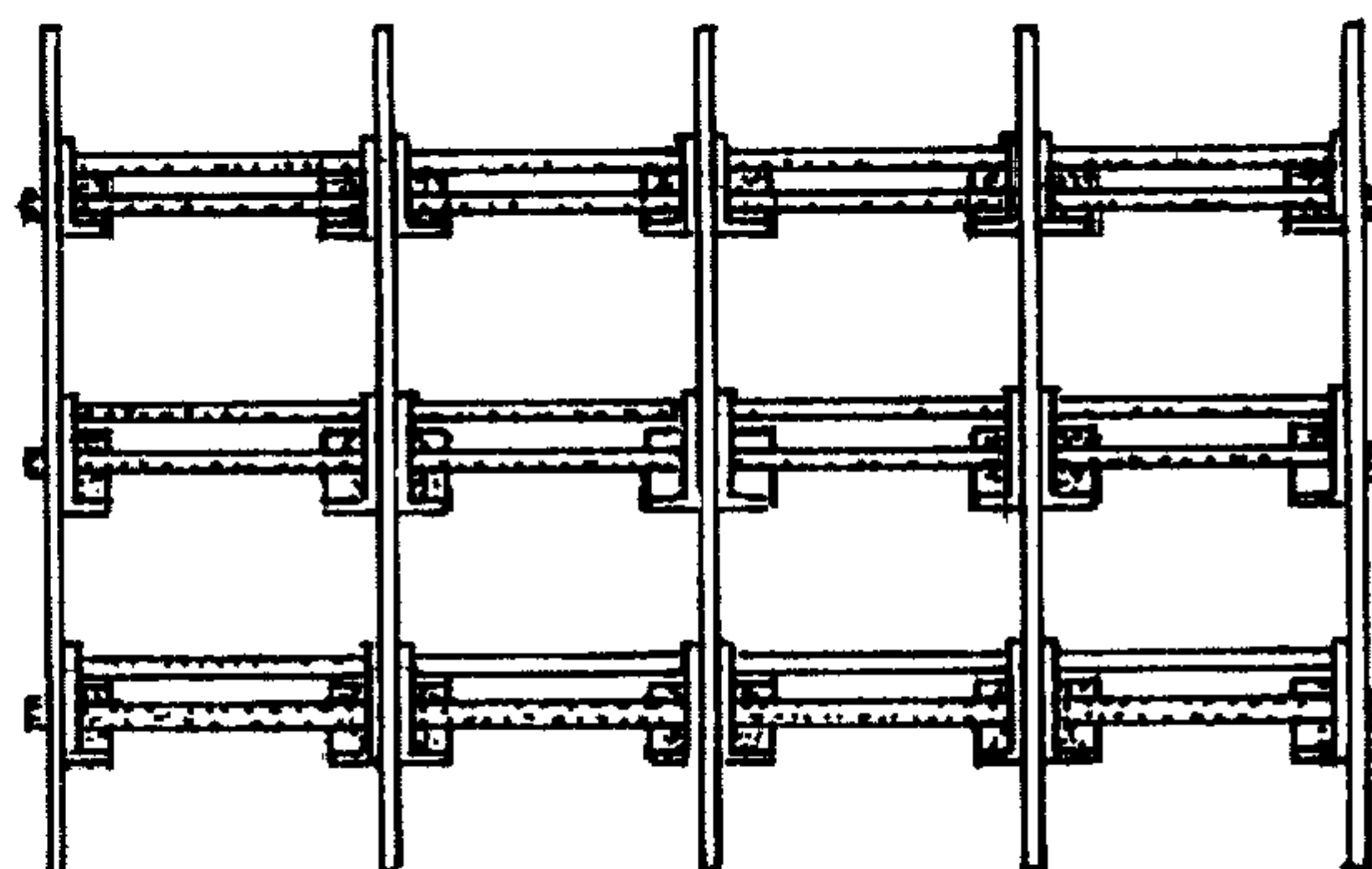

FIG. 6.