

[54] BINOCULAR

[75] Inventors: Alfred Hengst, Lahnau; Heinrich Janke, Braunfels; Hans-Kurt Uellenberg, Edingen; Heinz Keiner, Solms, all of Fed. Rep. of Germany

[73] Assignee: Ernst Leitz Wetzlar GmbH, Wetzlar, Fed. Rep. of Germany

[**] Term: 14 Years

[21] Appl. No.: 305,707

[22] Filed: Sep. 25, 1981

[30] Foreign Application Priority Data

Apr. 10, 1981 [DE] Fed. Rep. of Germany ... 5 MR 222

[51] Int. Cl. D16-06

[52] U.S. Cl. D16/132

[58] Field of Search D16/133; 350/553, 554, 350/558

[56] References Cited

U.S. PATENT DOCUMENTS

Re. 30,665	7/1981	Altenheiner et al.	350/554
D. 240,332	6/1976	Altenheiner et al.	D16/133
D. 255,364	6/1980	Lange	D16/133
3,604,779	9/1971	Reinhold	D16/133
3,817,594	6/1974	Fischer	350/546
4,087,153	5/1978	Hengst	350/554
4,186,992	2/1980	Kamakura	350/554
4,232,936	11/1980	Lange	350/553

Primary Examiner—Wallace R. Burke
Assistant Examiner—Horace B. Fay, Jr.

Attorney, Agent, or Firm—Wells & Wells

[57] CLAIM

The ornamental design for a binocular, as shown and described.

DESCRIPTION

FIG. 1 is a top front perspective view of a binocular showing our new design;
 FIG. 2 is a front elevational view thereof with the binocular in fully opened position;
 FIG. 3 is a rear elevational view thereof with the binocular in folded position and one ocular cylinder extended;
 FIG. 4 is a left side elevational view thereof;
 FIG. 5 is a right side elevational view thereof;
 FIG. 6 is a top view of the binocular as fully open in FIG. 2;
 FIG. 7 is a bottom view of the binocular as fully open in FIG. 2;
 FIG. 8 is a top front perspective view of a second embodiment of a binocular showing our new design;
 FIG. 9 is a front elevational view thereof with the binocular in fully opened position;
 FIG. 10 is a rear elevational view thereof with the binocular in folded position and one ocular cylinder extended;
 FIG. 11 is a left side elevational view thereof;
 FIG. 12 is a right side elevational view thereof;
 FIG. 13 is a top view thereof;
 FIG. 14 is a bottom view thereof.
 The broken line section of the binocular cord shown in FIG. 1 is intended to signify a cord of indeterminate length.

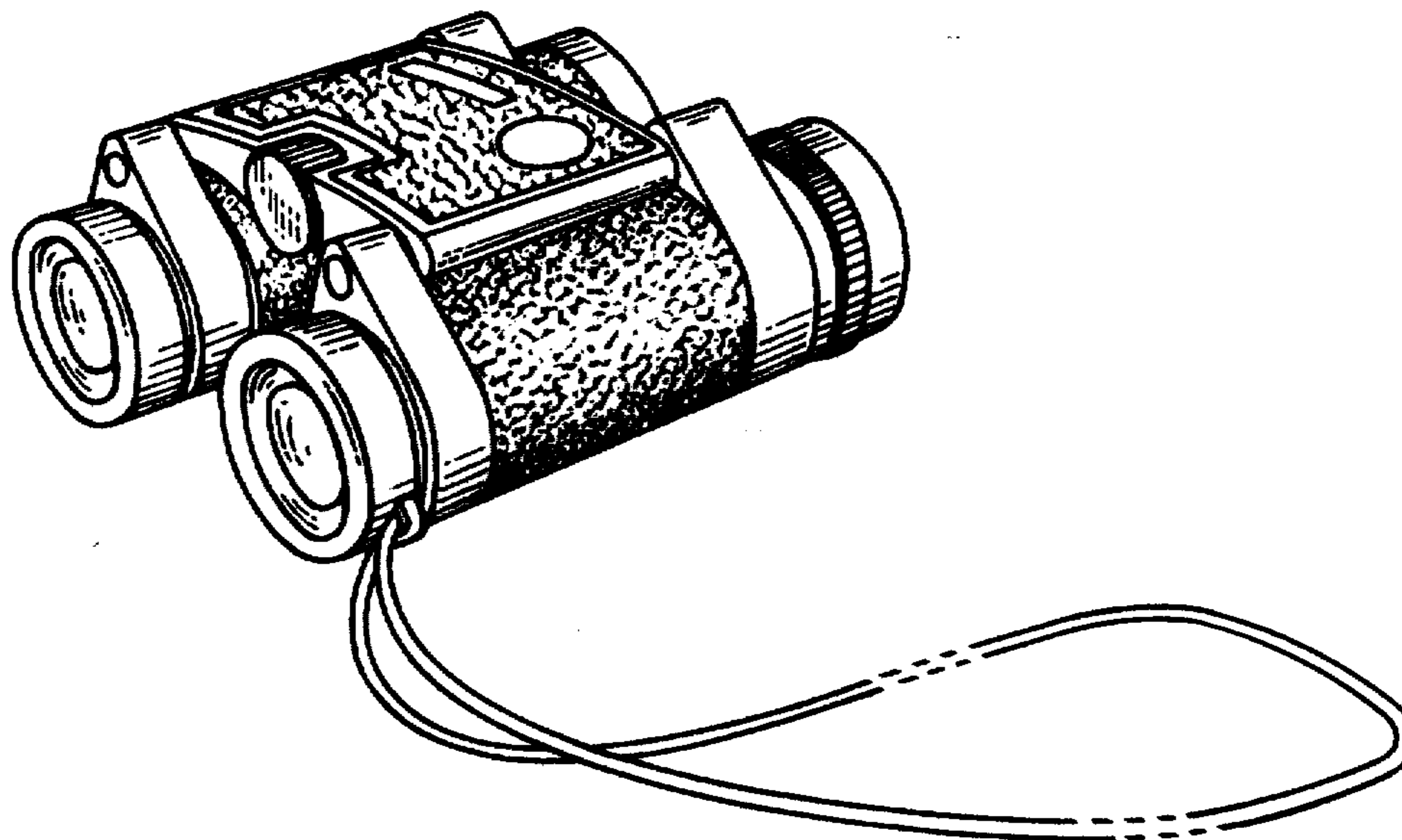

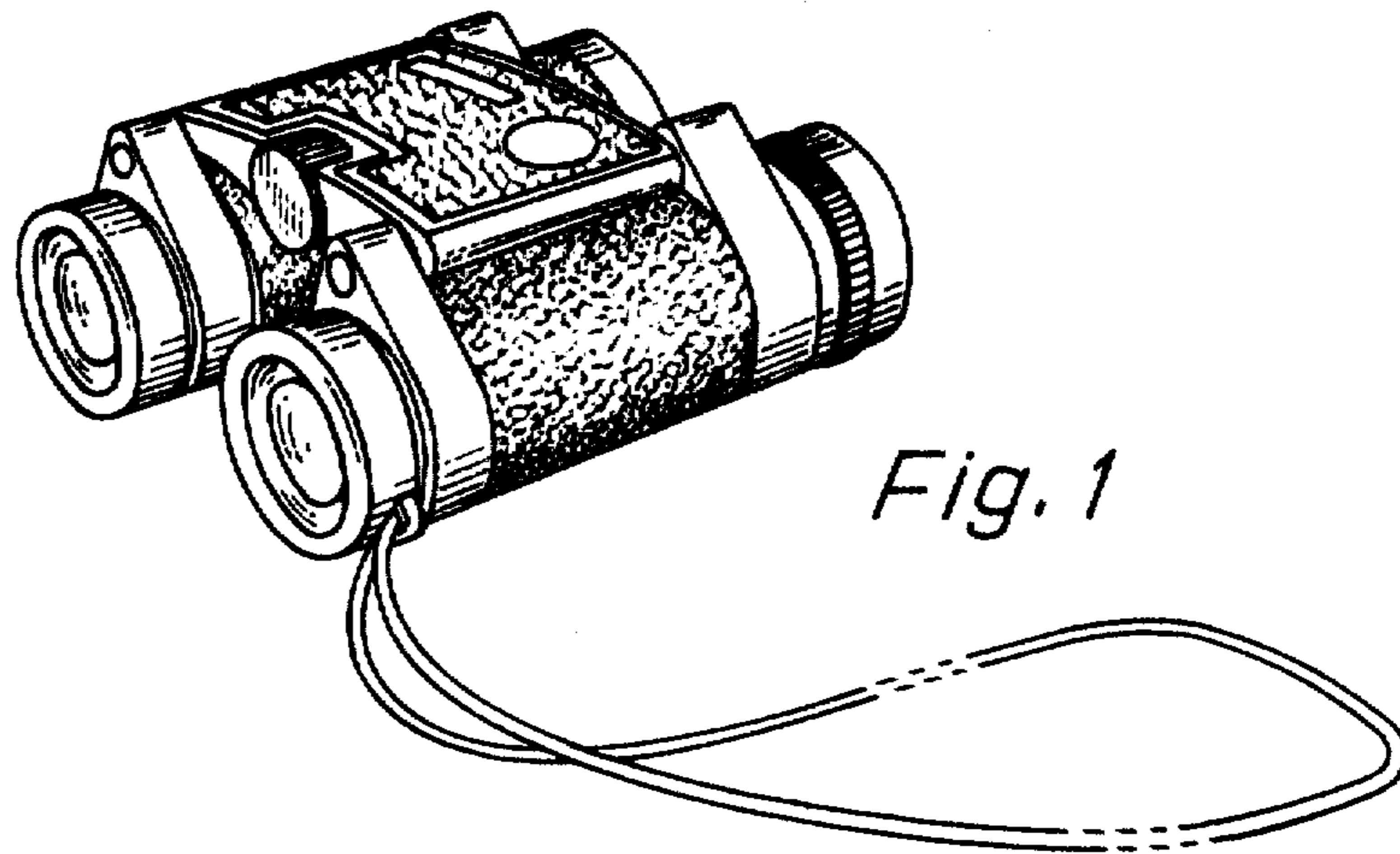

Fig. 1

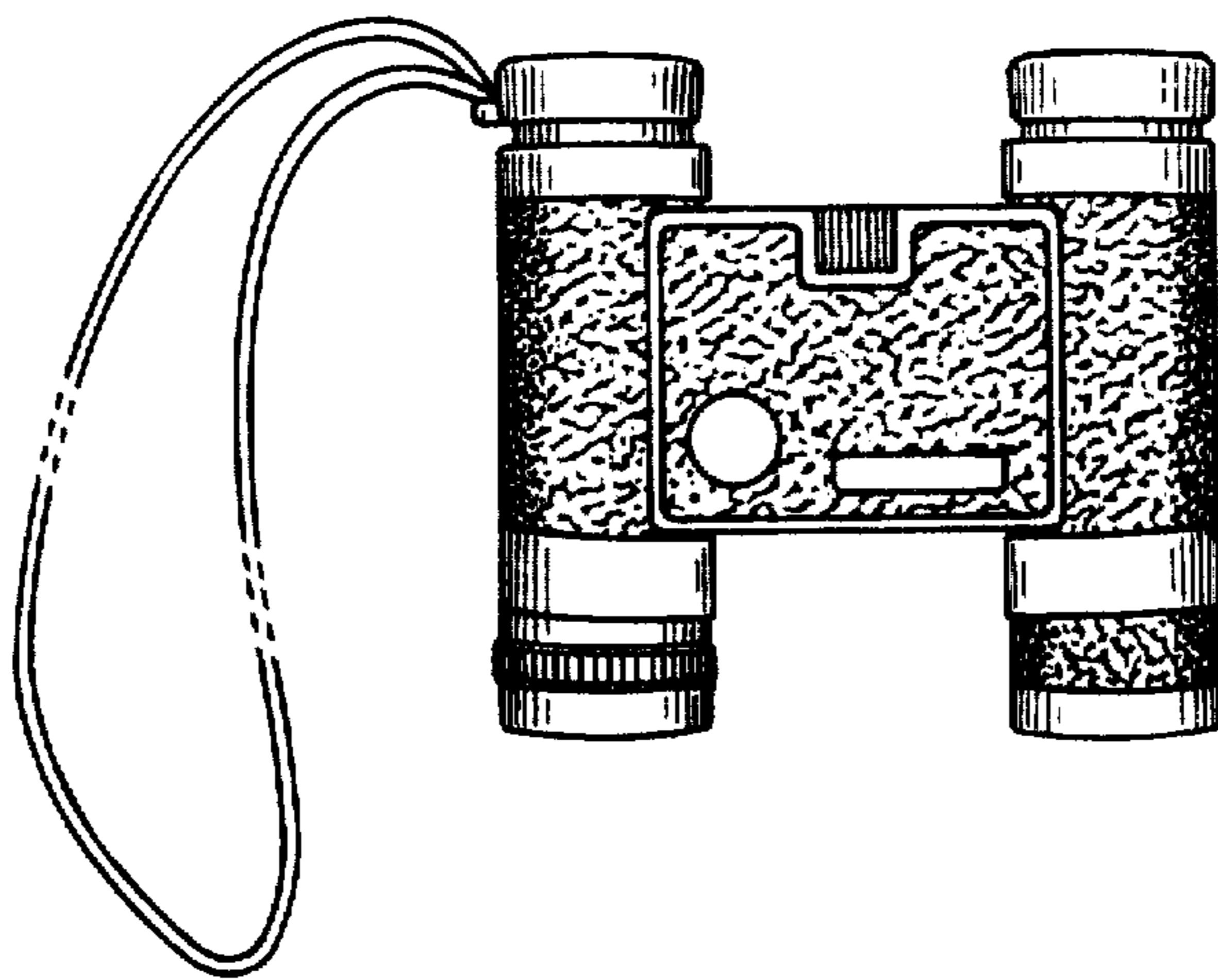

Fig. 2

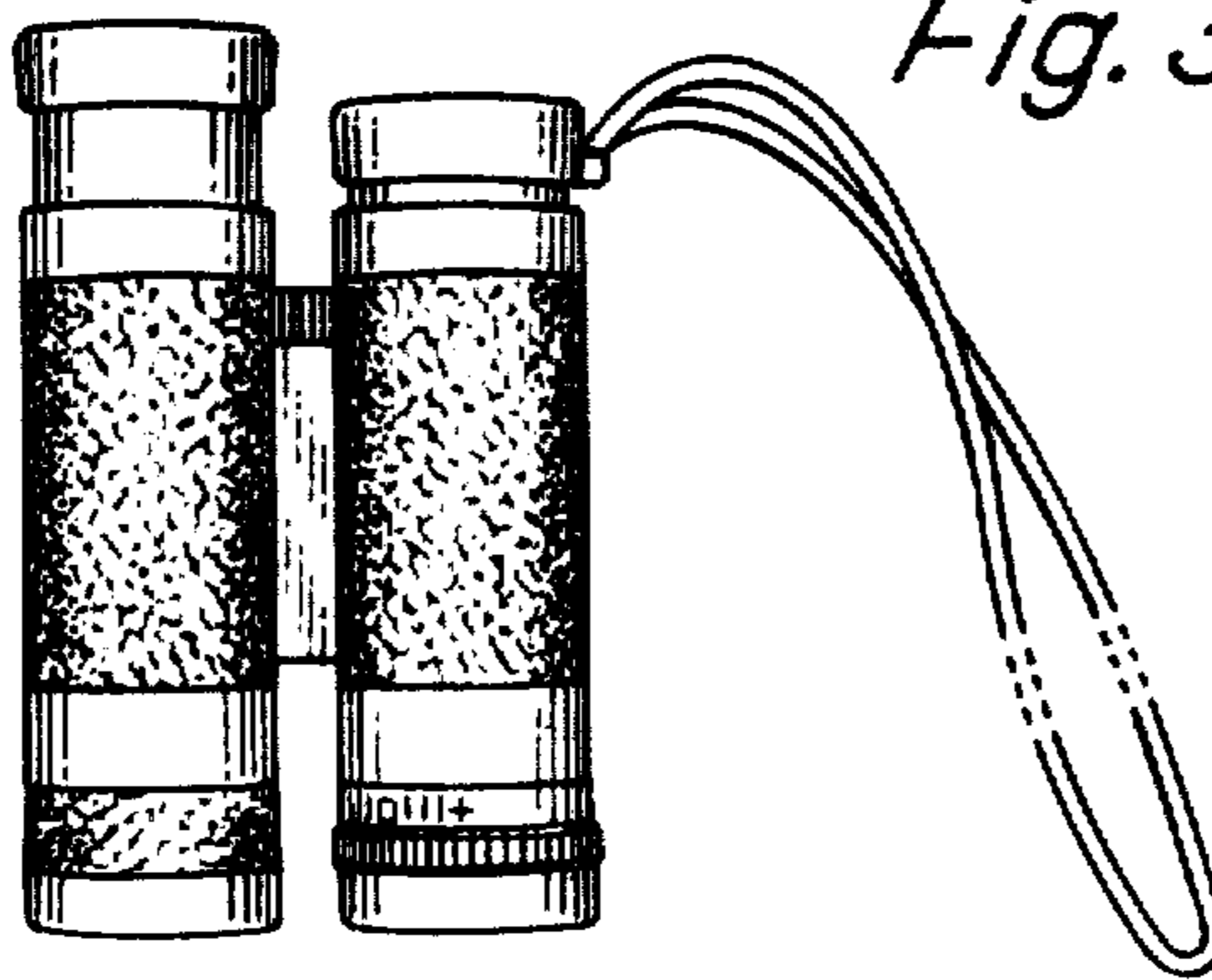

Fig. 3

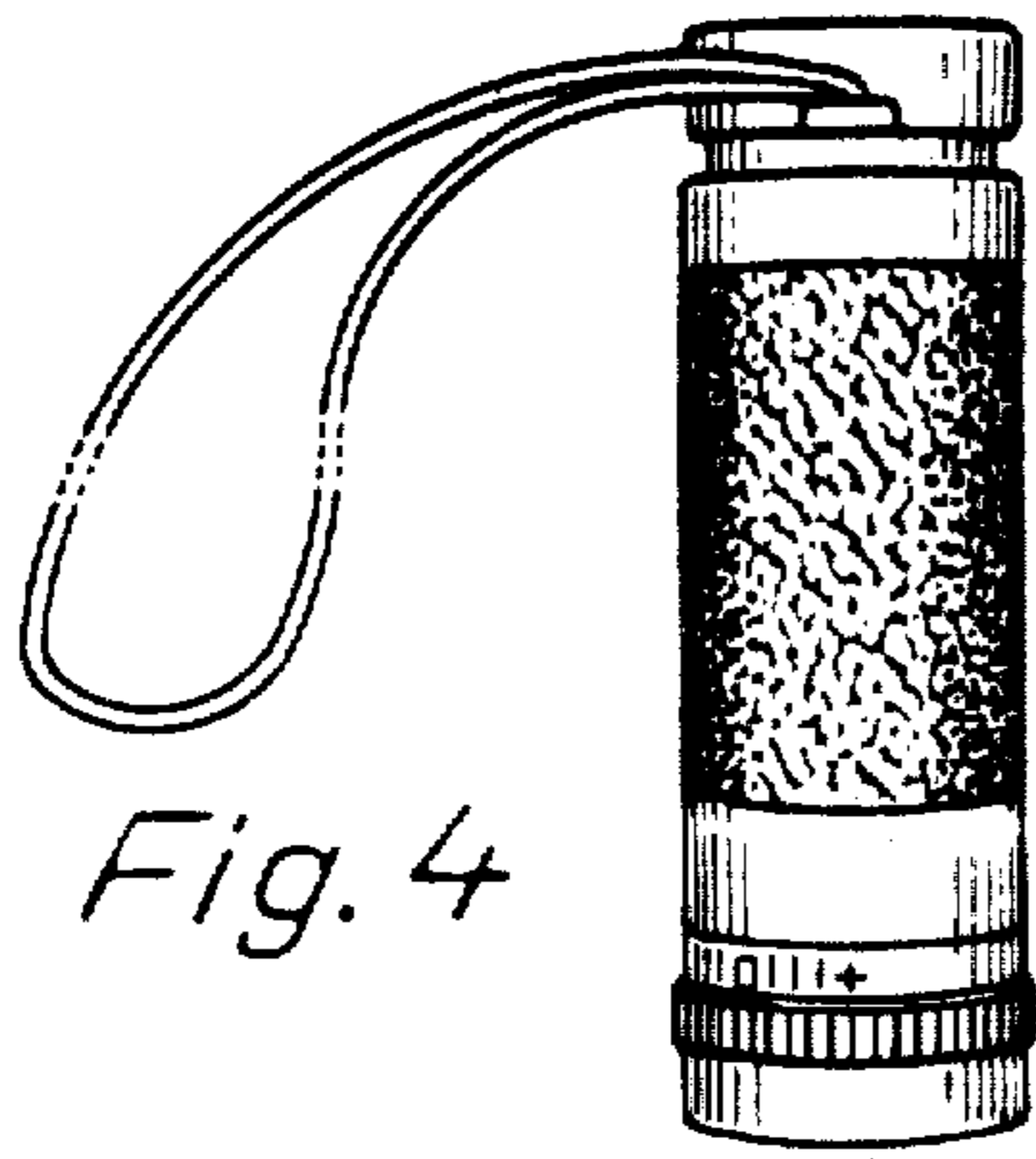

Fig. 4

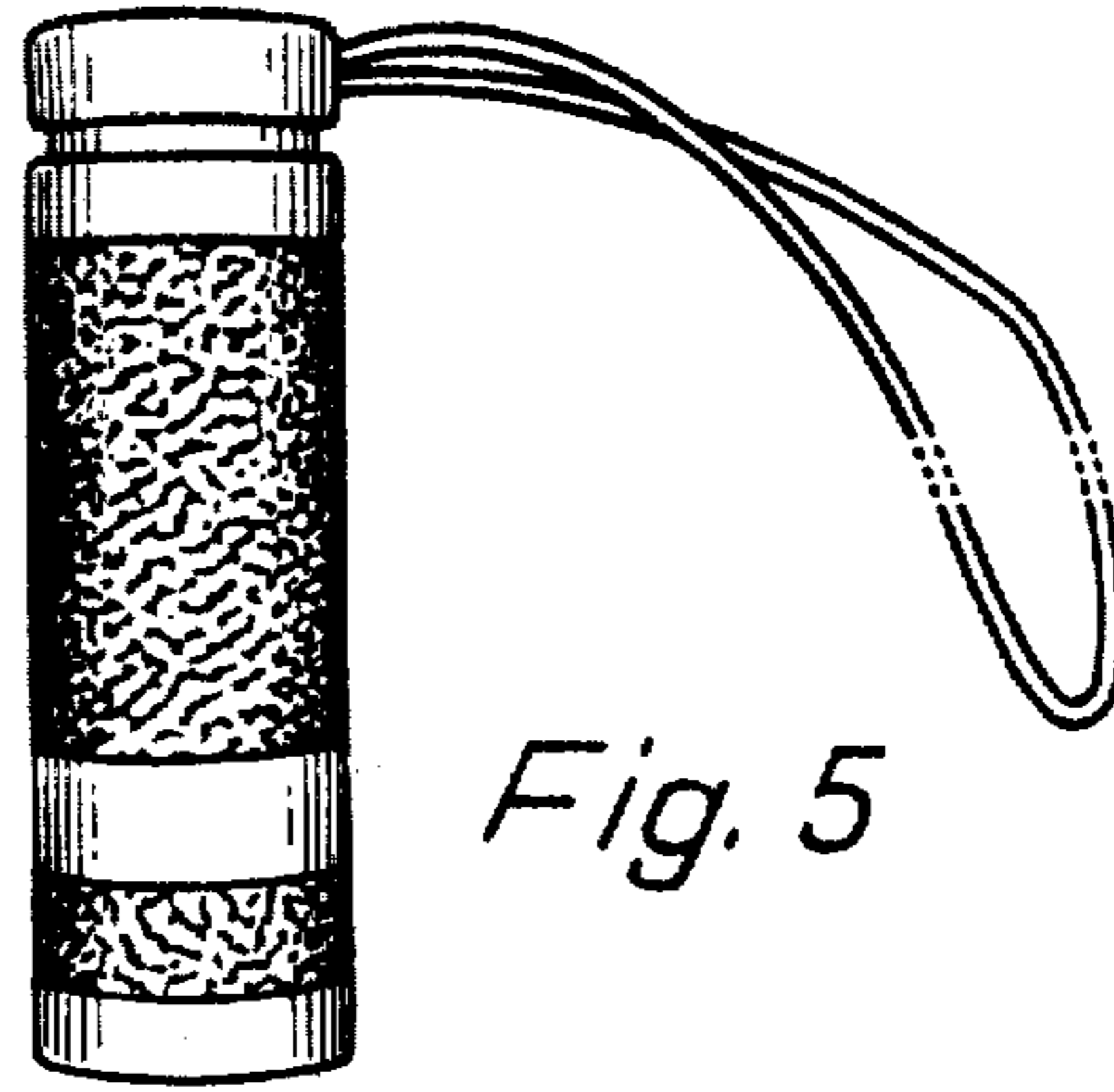

Fig. 5

Fig. 6

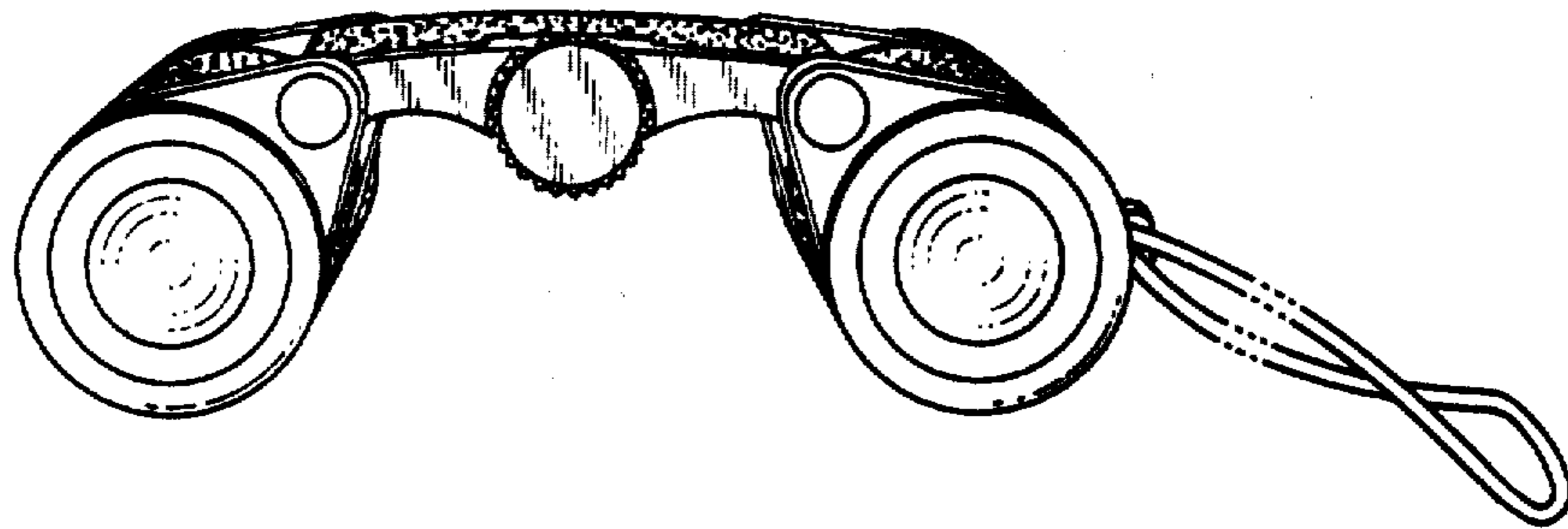
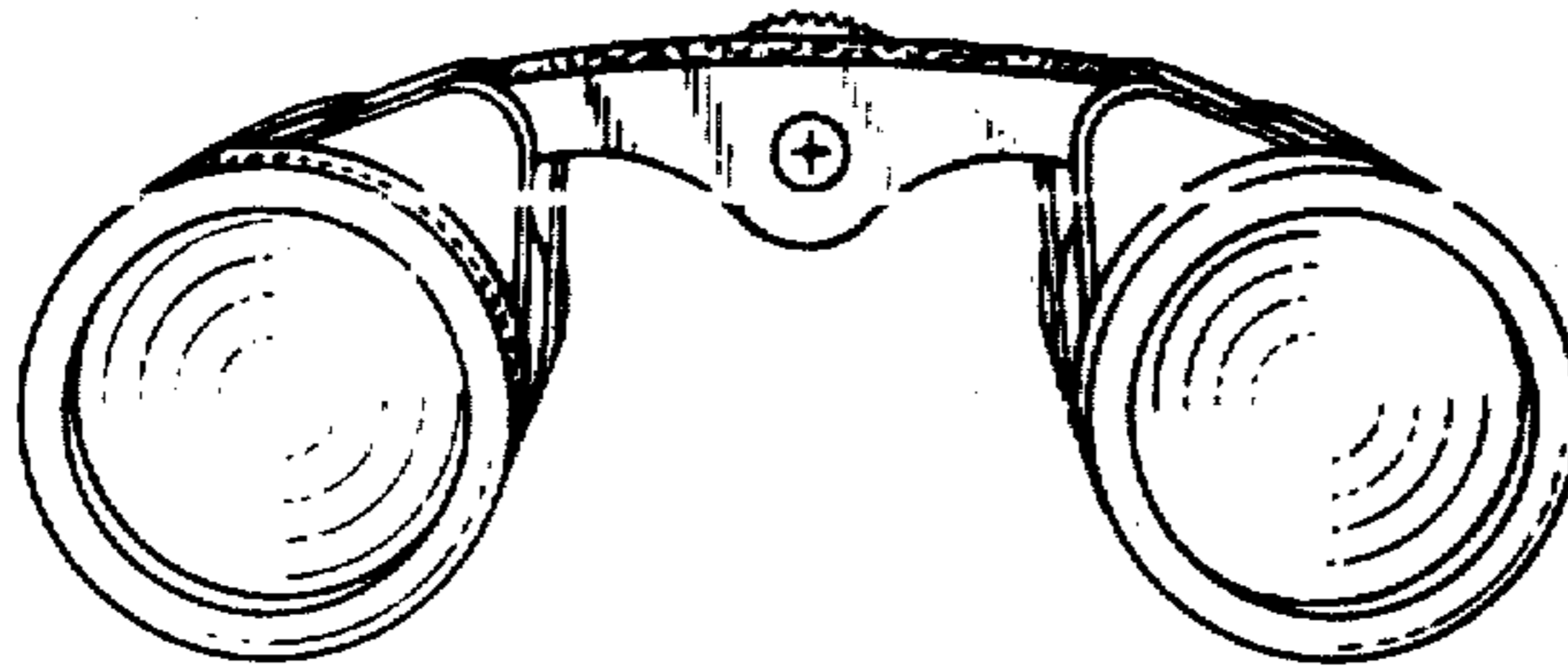

Fig. 7



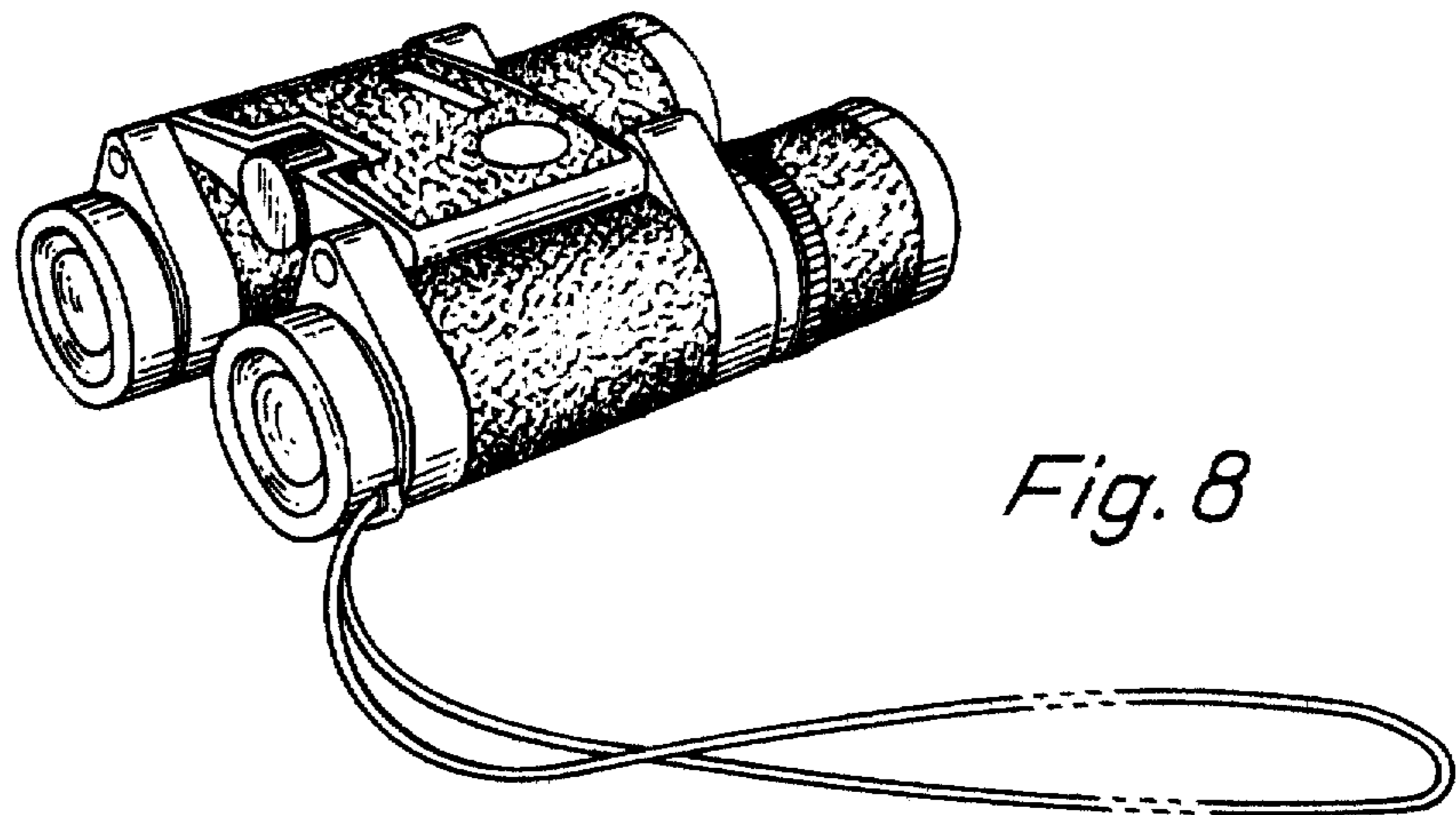

Fig. 8

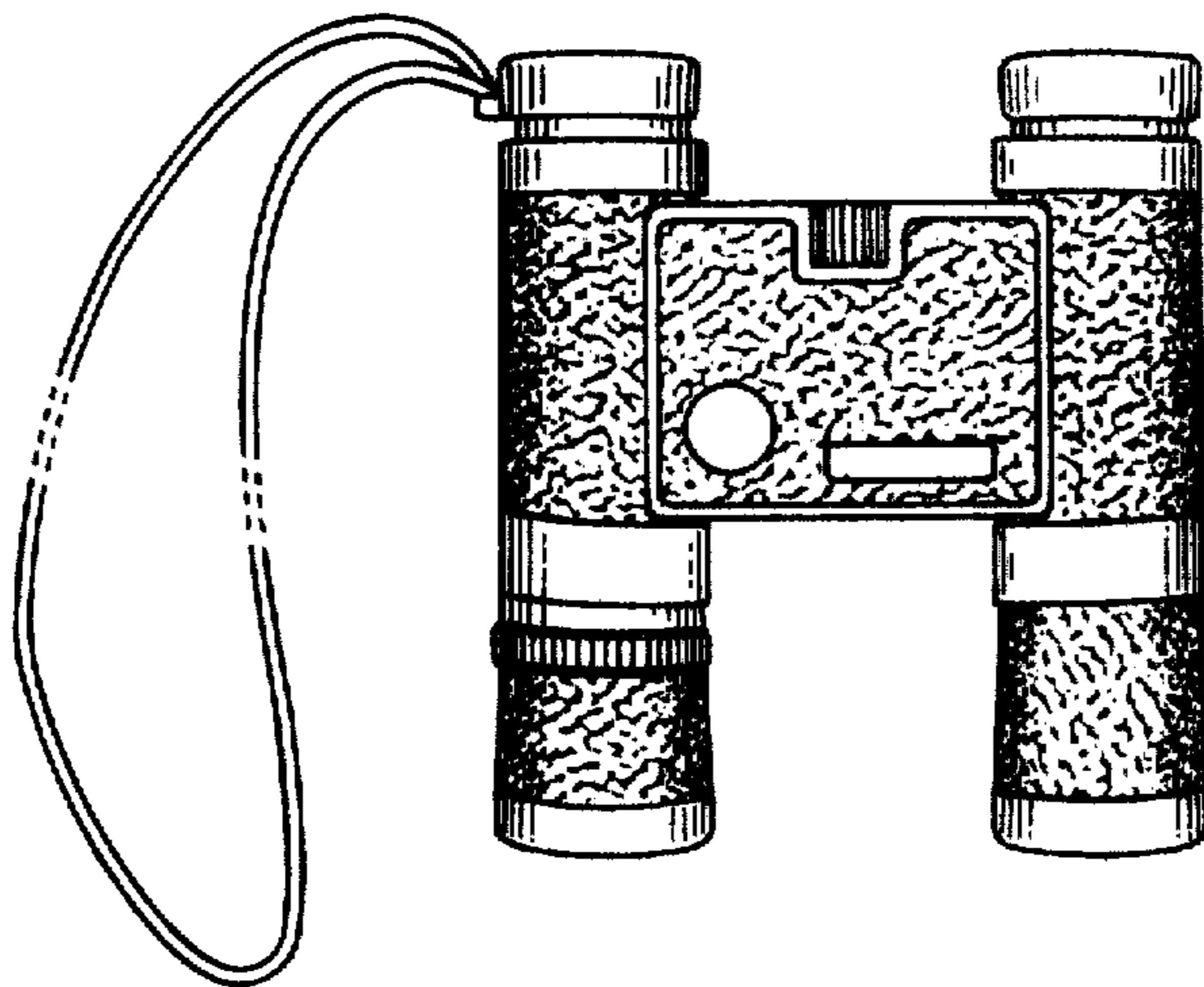

Fig. 9

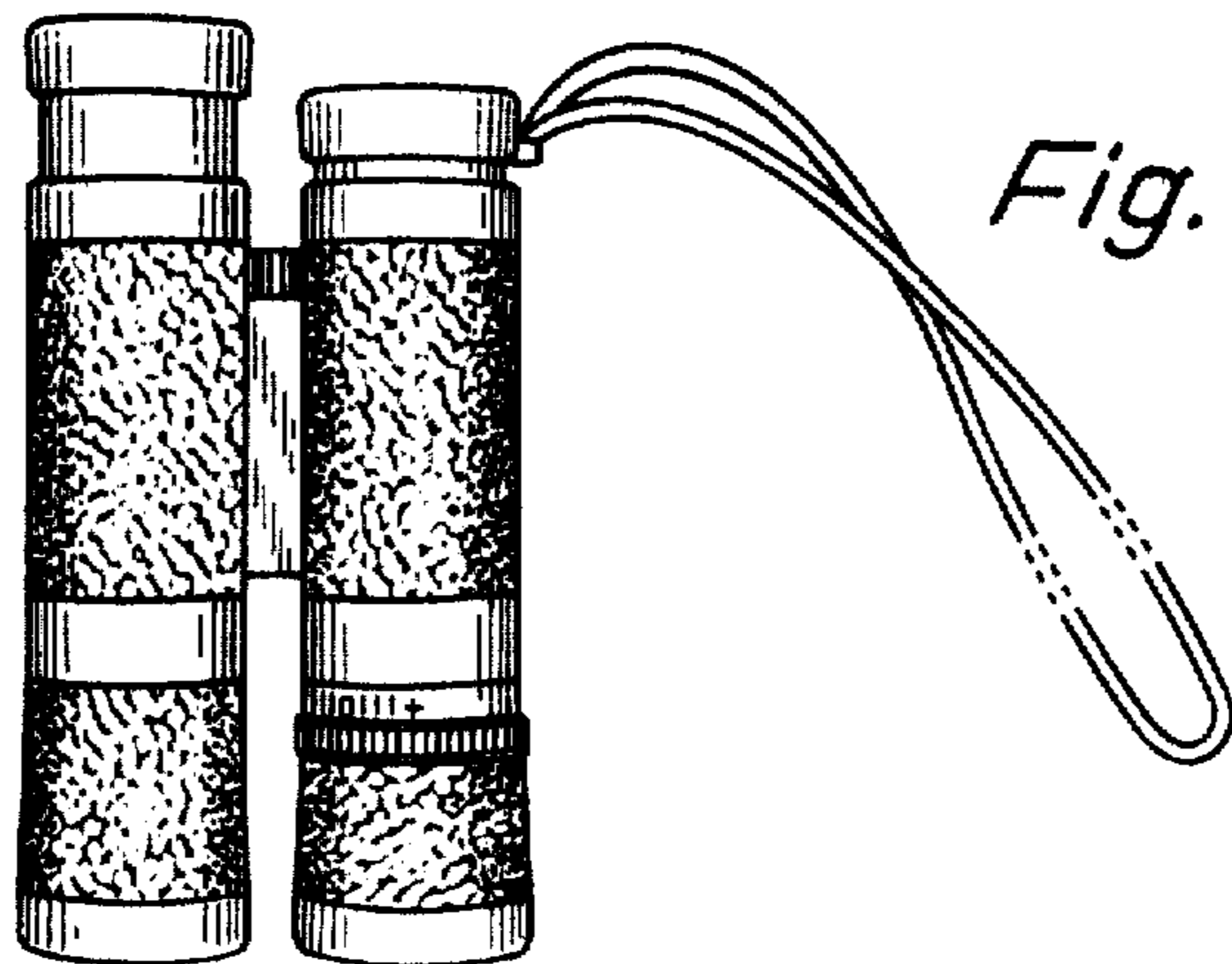

Fig. 10

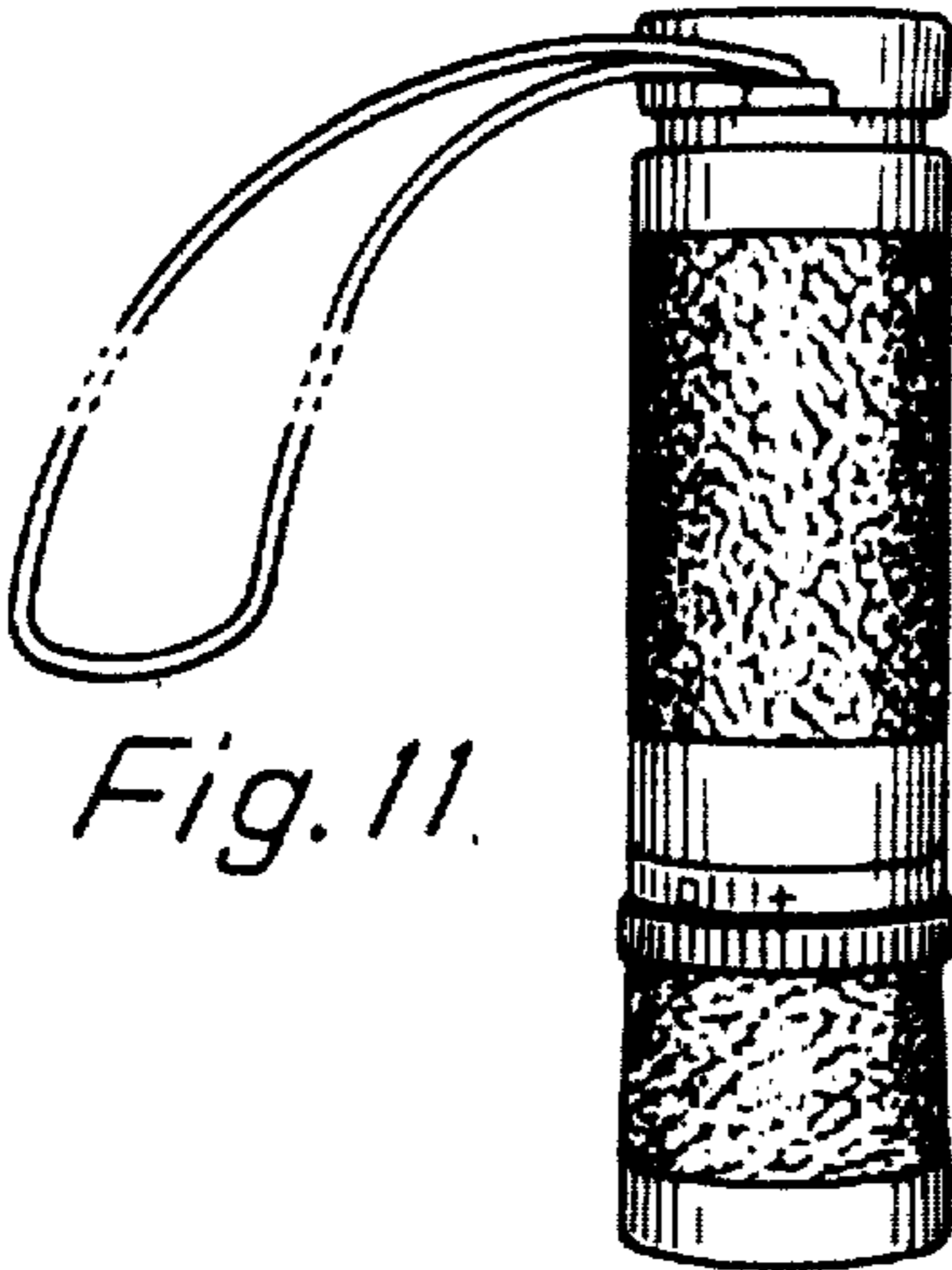

Fig. 11.

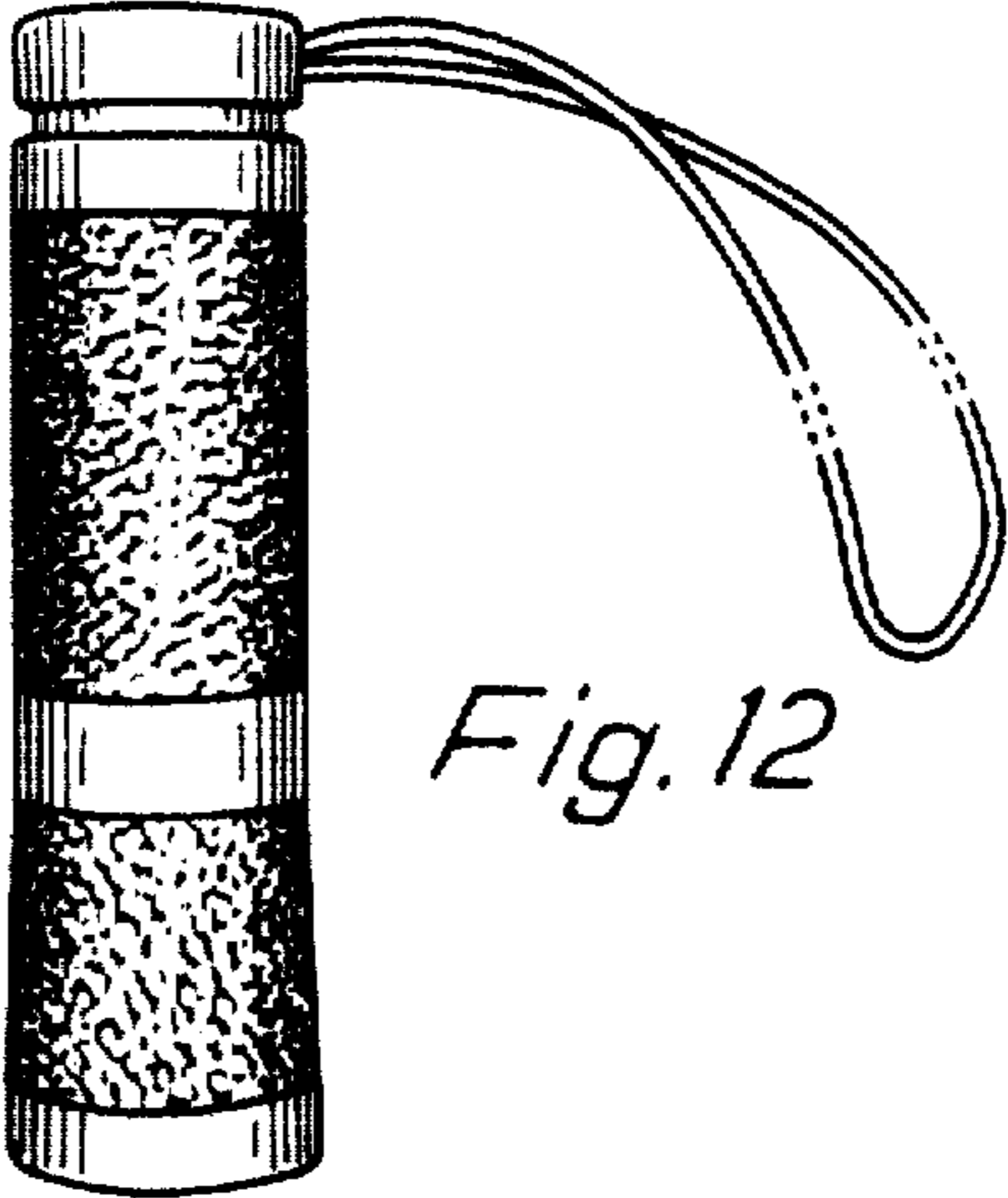

Fig. 12

Fig. 13

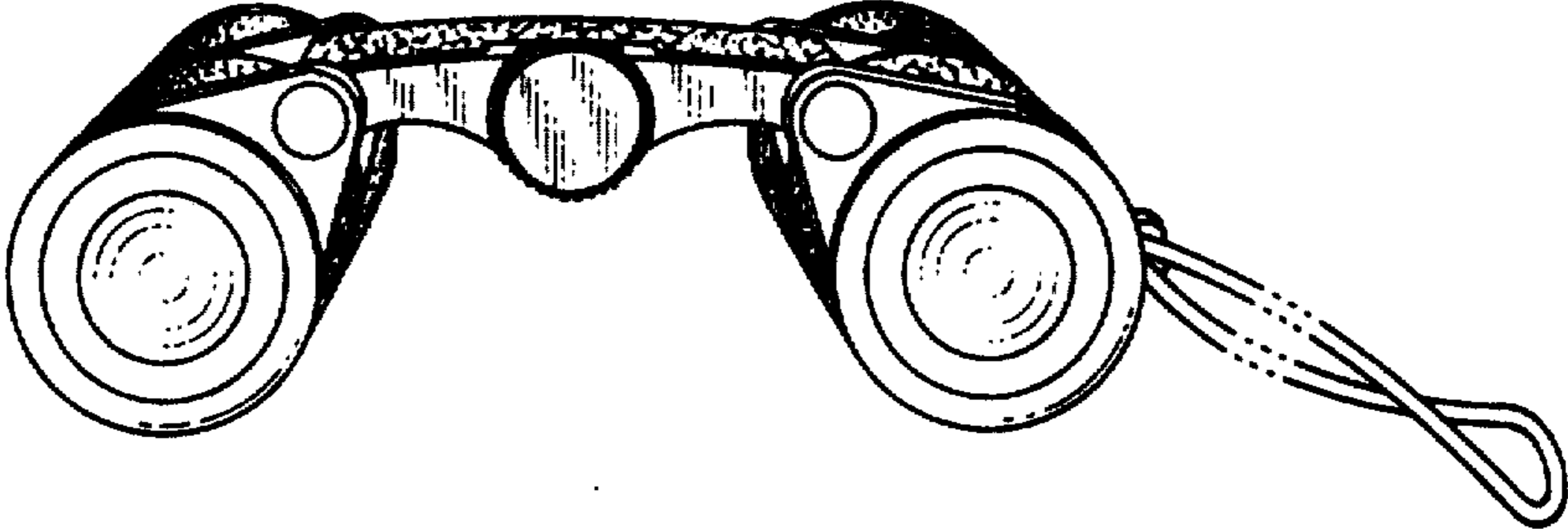

Fig. 14

