

[54] COMBINED OUTBOARD MOTOR AND MOUNTING BRACKET ASSEMBLY THEREFOR

[75] Inventors: Charles B. Hall, Ingleside, Ill.; Myron T. Stevens, Kenosha, Wis.; Paul B. Specht, Wilmette, Ill.

[73] Assignee: Outboard Marine Corporation, Waukegan, Ill.

[\*\*] Term: 14 Years

[21] Appl. No.: 299,152

[22] Filed: Sep. 3, 1981

[51] Int. Cl. .... D15-01

[52] U.S. Cl. .... D15/4

[58] Field of Search ..... D15/4; 440/52, 53; 248/640, 641, 642, 643

[56] References Cited

U.S. PATENT DOCUMENTS

D. 192,770	5/1962	Andersson-Sason .....	D15/4
3,884,174	5/1975	Larsen .....	440/53
3,934,537	1/1976	Hall .....	440/53
4,177,747	12/1979	Pichl .....	440/52
4,352,666	10/1982	McGowan .....	440/53

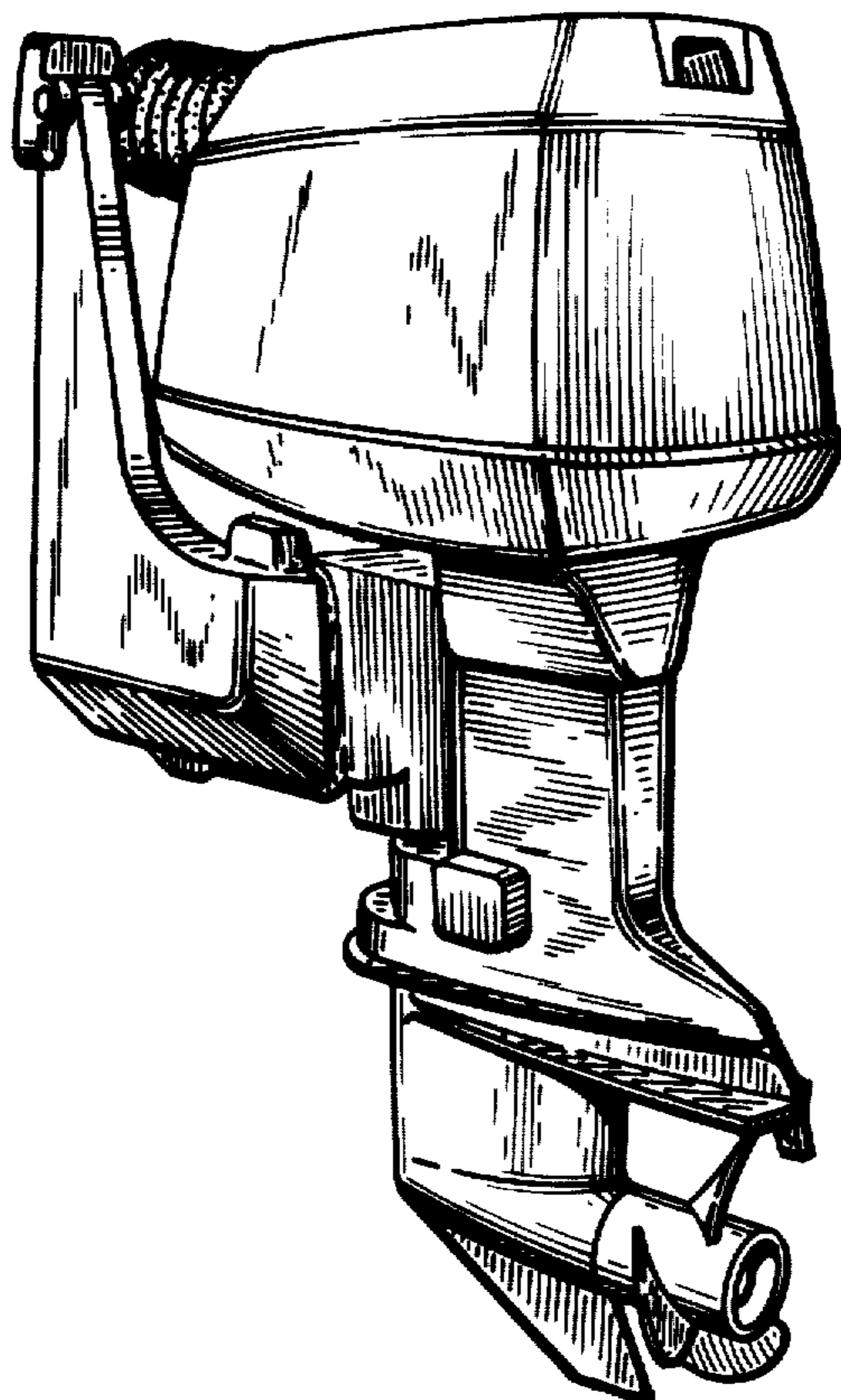
Primary Examiner—Wallace R. Burke  
Assistant Examiner—Lynn Wilder  
Attorney, Agent, or Firm—Michael, Best & Friedrich

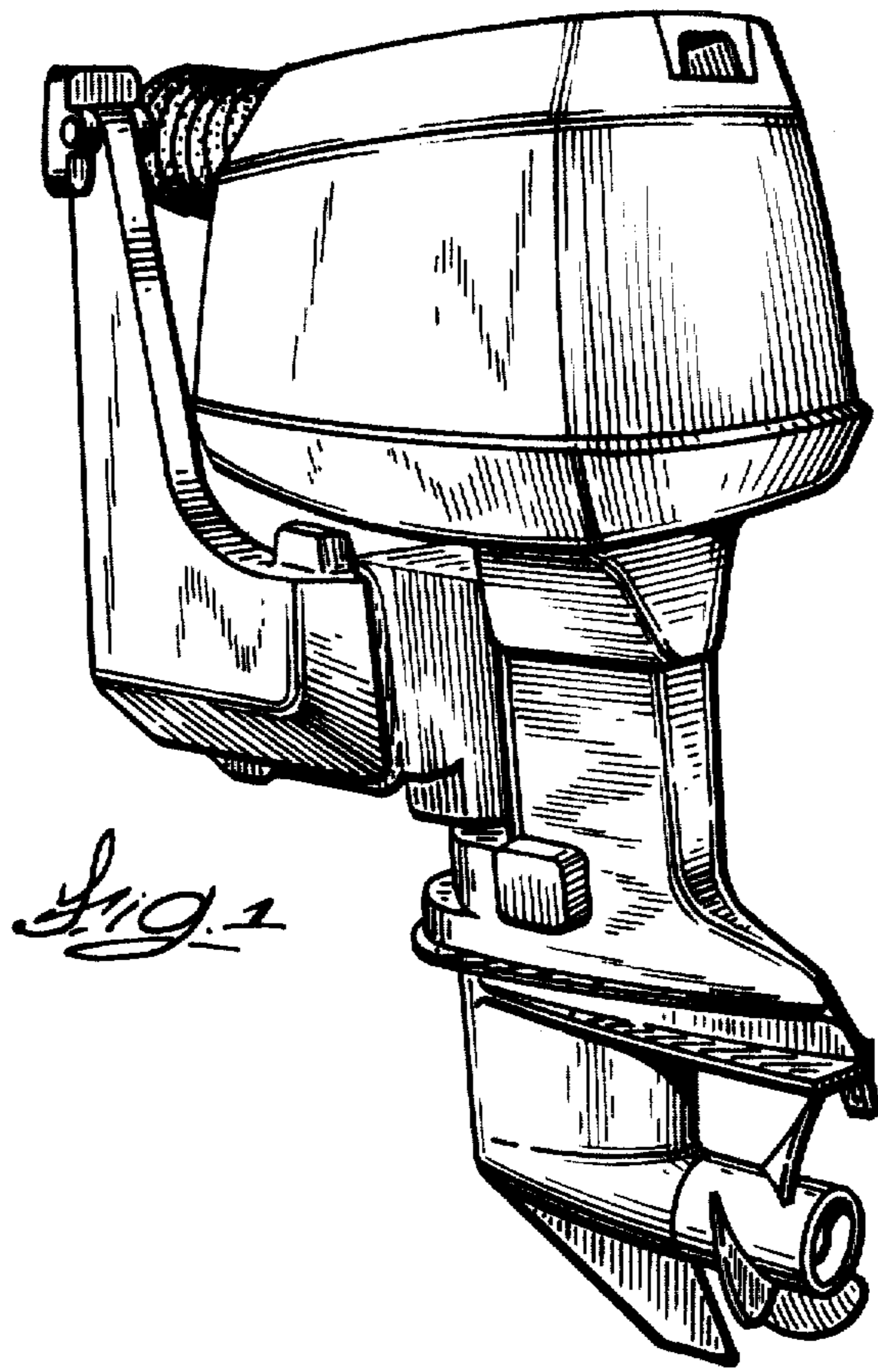
[57] CLAIM

The ornamental design of a combined outboard motor and mounting bracket assembly therefor, as shown.

DESCRIPTION

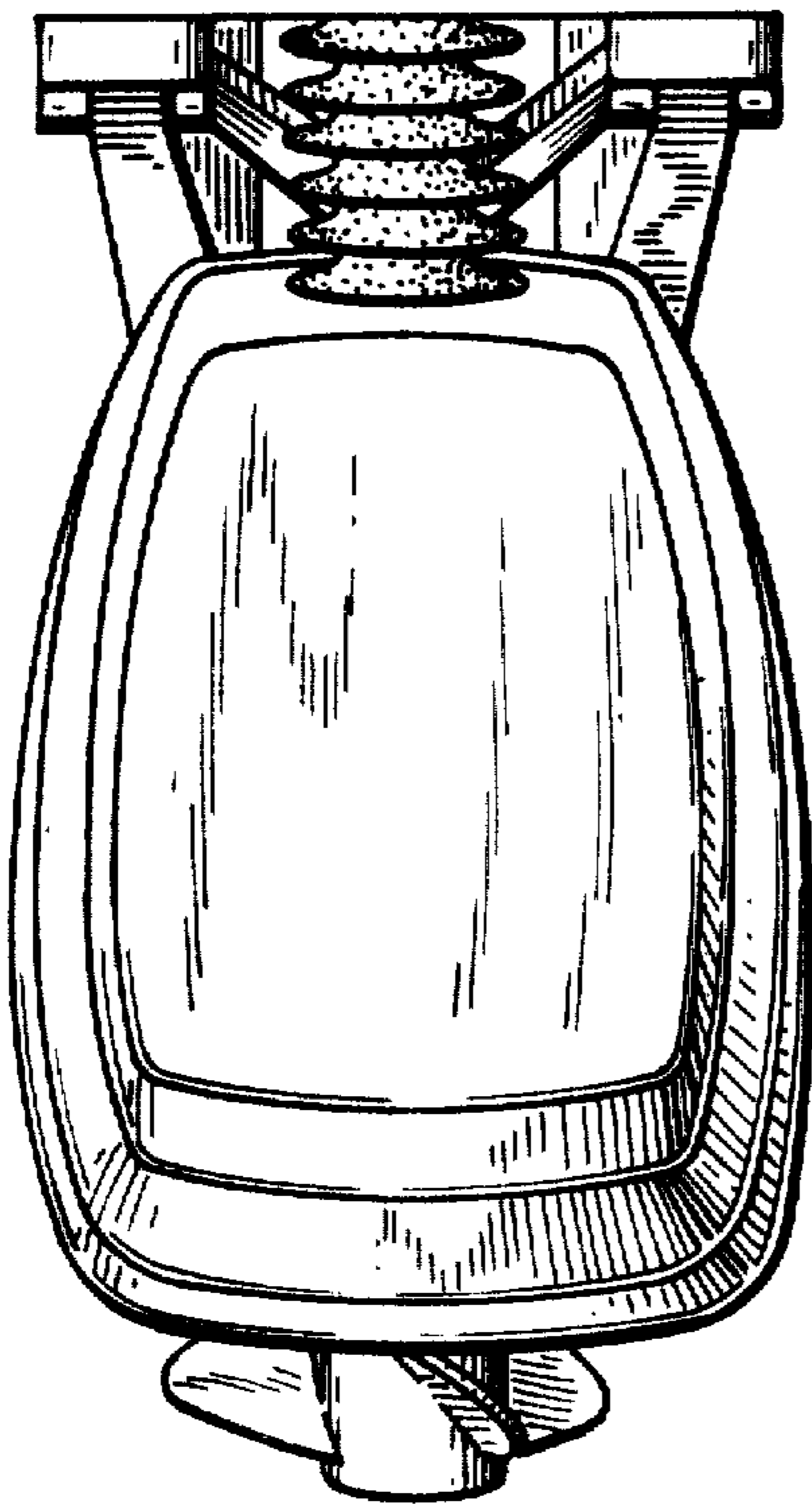
FIG. 1 is a perspective view of a combined outboard motor and mounting bracket assembly therefor showing my new design;  
FIG. 2 is a top plan view thereof;  
FIG. 3 is a bottom plan view thereof;  
FIG. 4 is a side elevational view thereof;  
FIG. 5 is a rear elevational view thereof; and  
FIG. 6 is a front elevational view thereof.



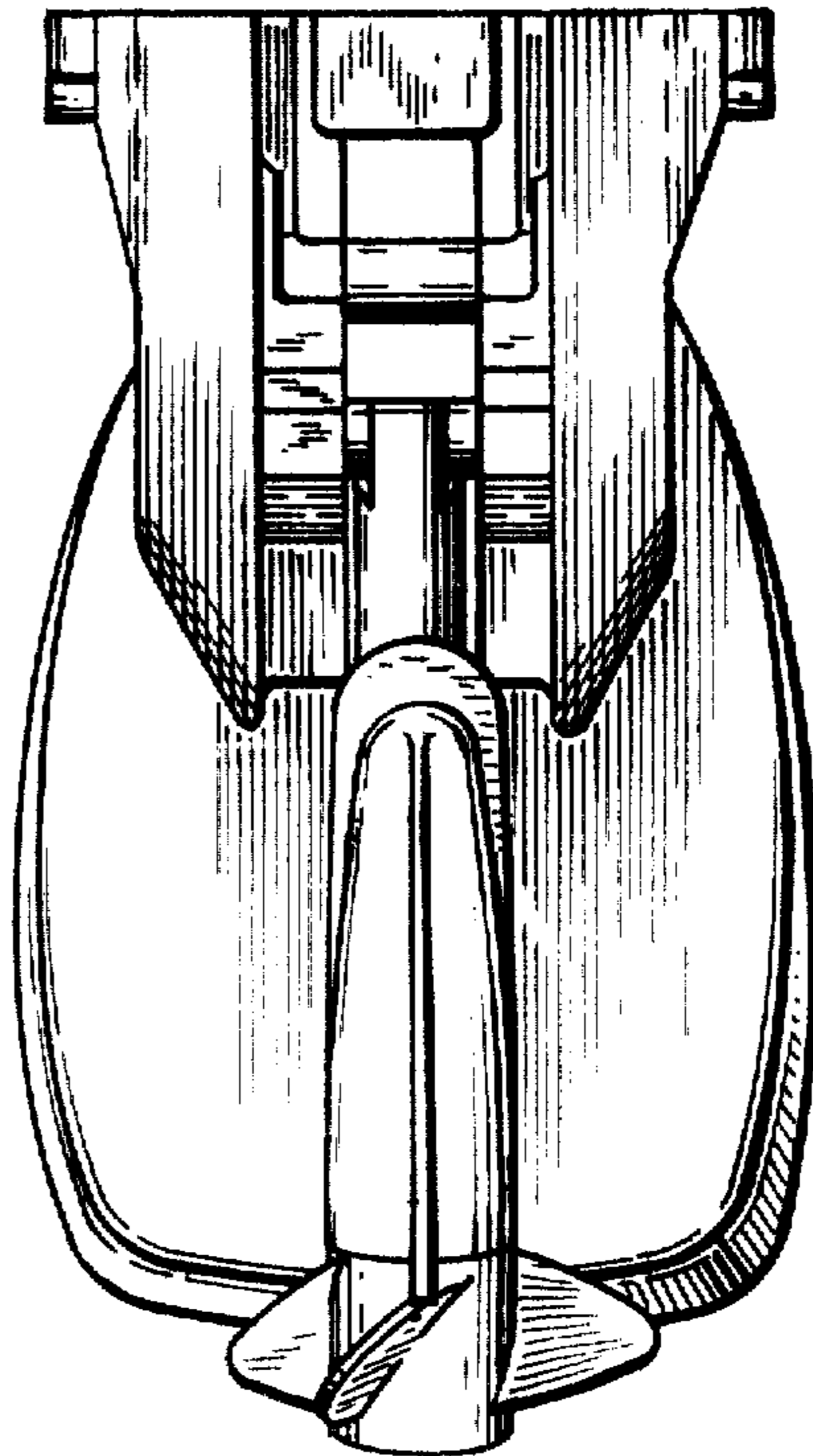


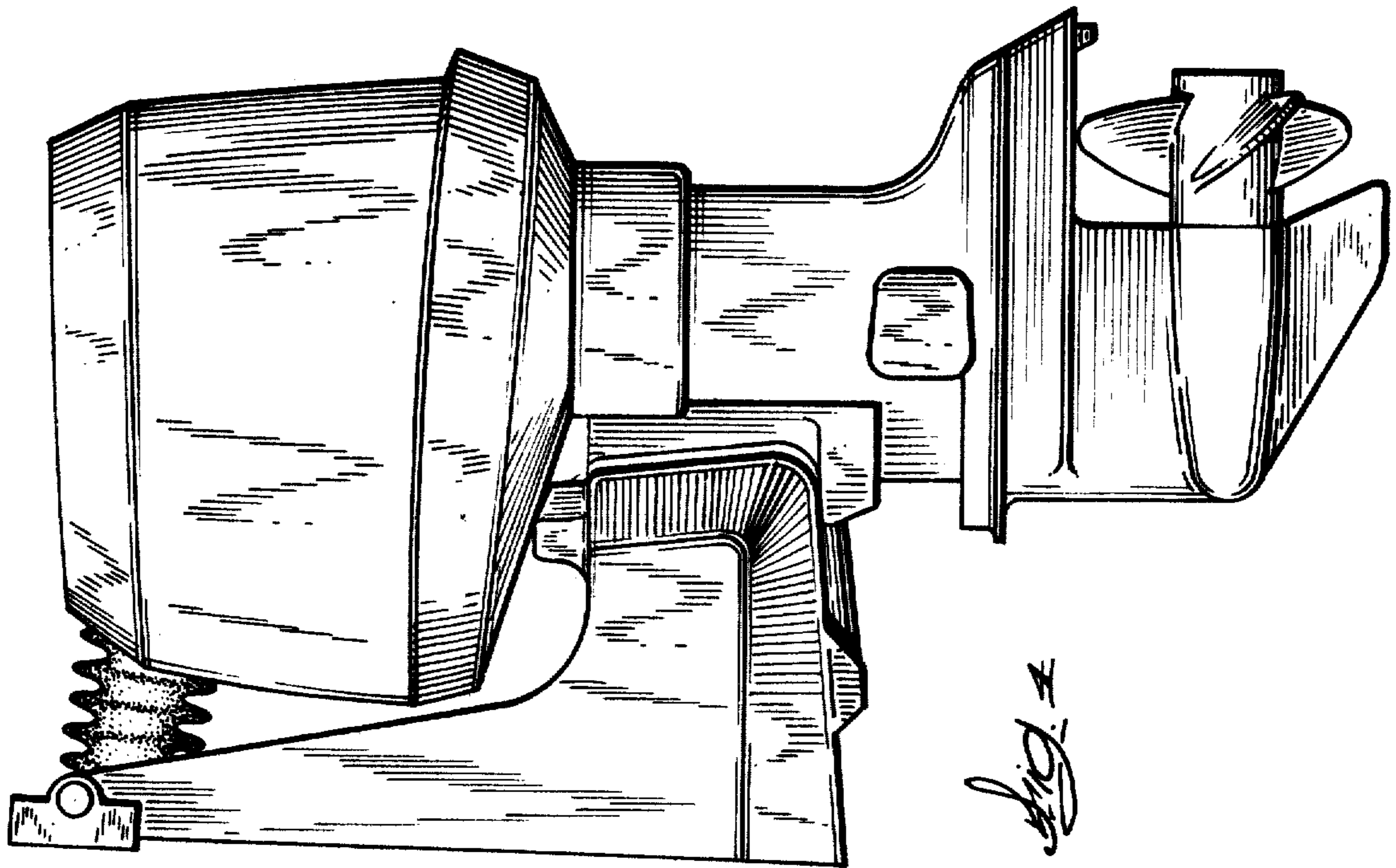
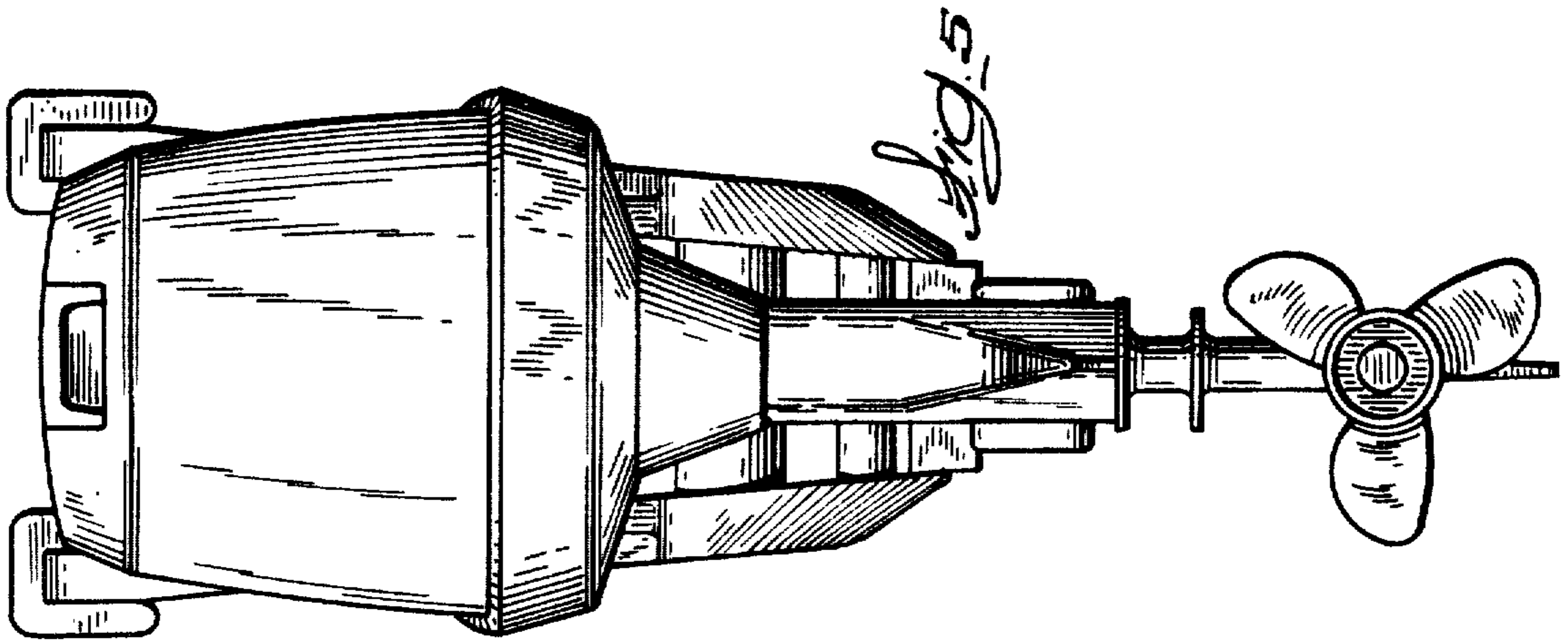
*Fig. 1*

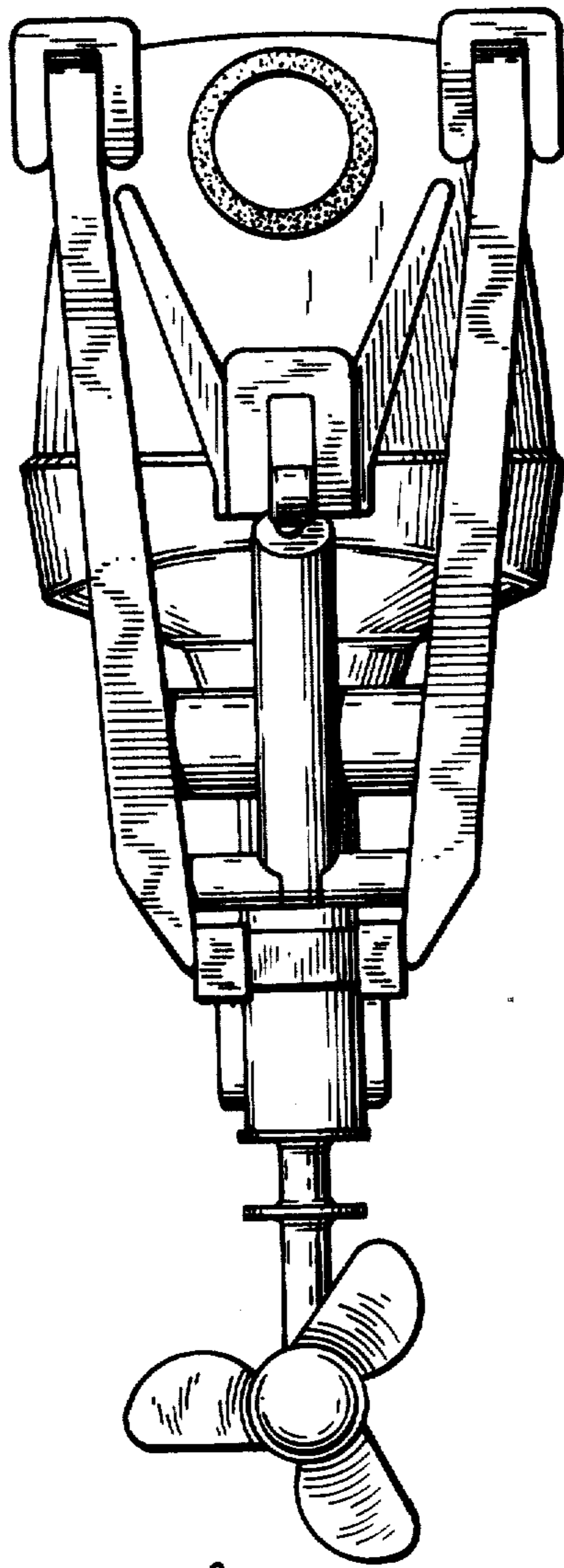
*Fig. 2*



*Fig. 3*







*Fig. 6*