

[54] ELECTRONIC PRINTER

[75] Inventors: Haruyuki Seki; Chiaki Kuroiwa, both of Shiojiri, Japan

[73] Assignees: Epson Corporation, Nagano; Kabushiki Kaisha Suwa Seikosha, Tokyo, both of Japan

[**] Term: 14 Years

[21] Appl. No.: 282,995

[22] Filed: Jul. 14, 1981

[30] Foreign Application Priority Data

Feb. 12, 1981 [JP] Japan 56-5178

[51] Int. Cl. D14-02

[52] U.S. Cl. D14/111

[58] Field of Search D14/100-117; 364/900; 400/693; D18/13, 18, 22, 23

[56] References Cited

U.S. PATENT DOCUMENTS

D. 236,835 9/1975 Kramer et al. D14/111

OTHER PUBLICATIONS

Computer Products, 4-1980, p. 3, Systems Furniture Co., Ad, Printer.

Computer Products, 4-1980, p. 20, Line Printer (Radio Shack) (lower left of photograph).

Primary Examiner—Susan J. Lucas
Attorney, Agent, or Firm—Blum, Kaplan, Friedman, Silberman & Beran

CLAIM

[57] The ornamental design for an electronic printer, as shown and described.

DESCRIPTION

FIG. 1 is a front view of an electronic printer showing our new design;
FIG. 2 is a top plan view thereof;
FIG. 3 is a right side view thereof;
FIG. 4 is a left side view thereof;
FIG. 5 is a rear elevational view thereof;
FIG. 6 is a bottom plan view thereof; and
FIG. 7 is a perspective view thereof.

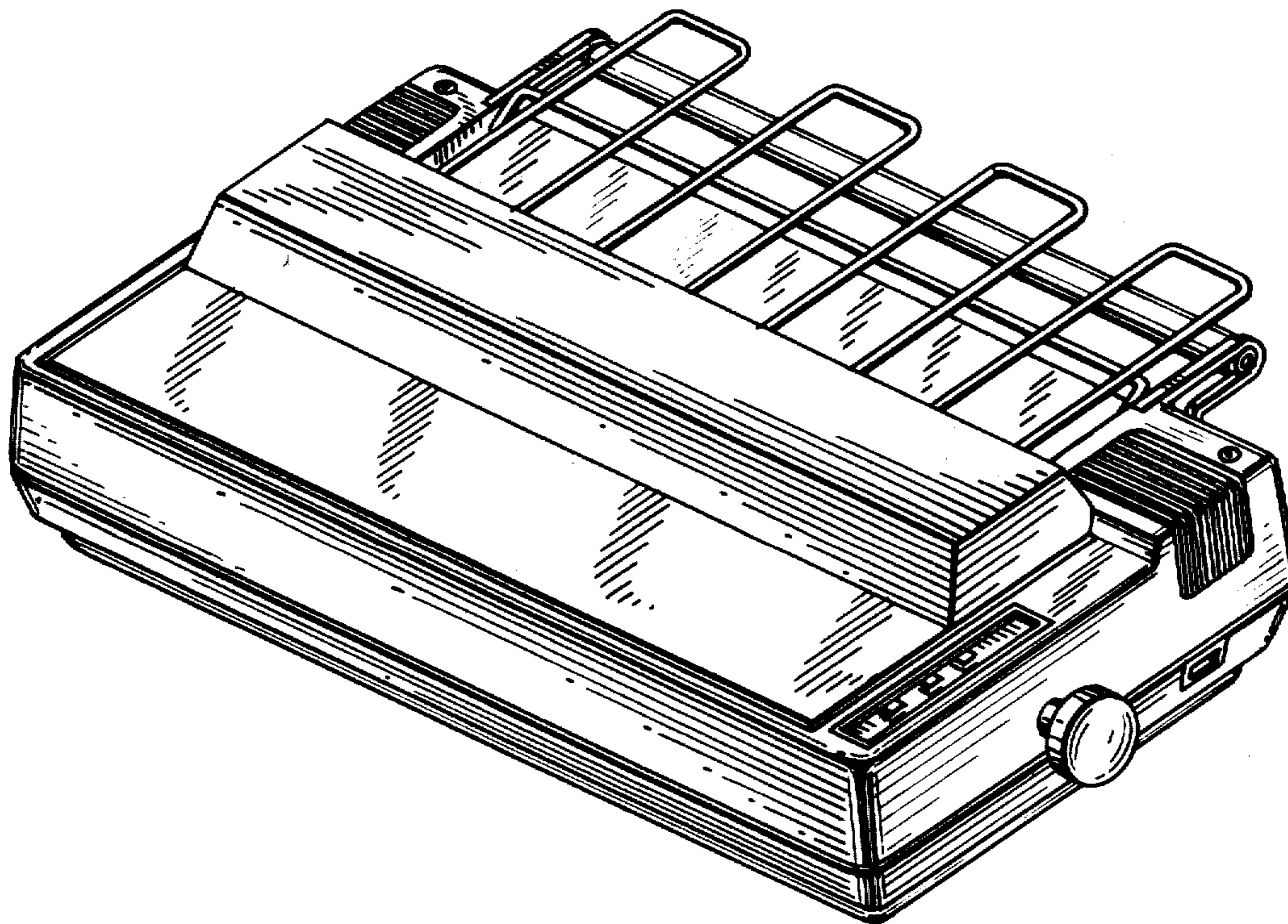

FIG. 1

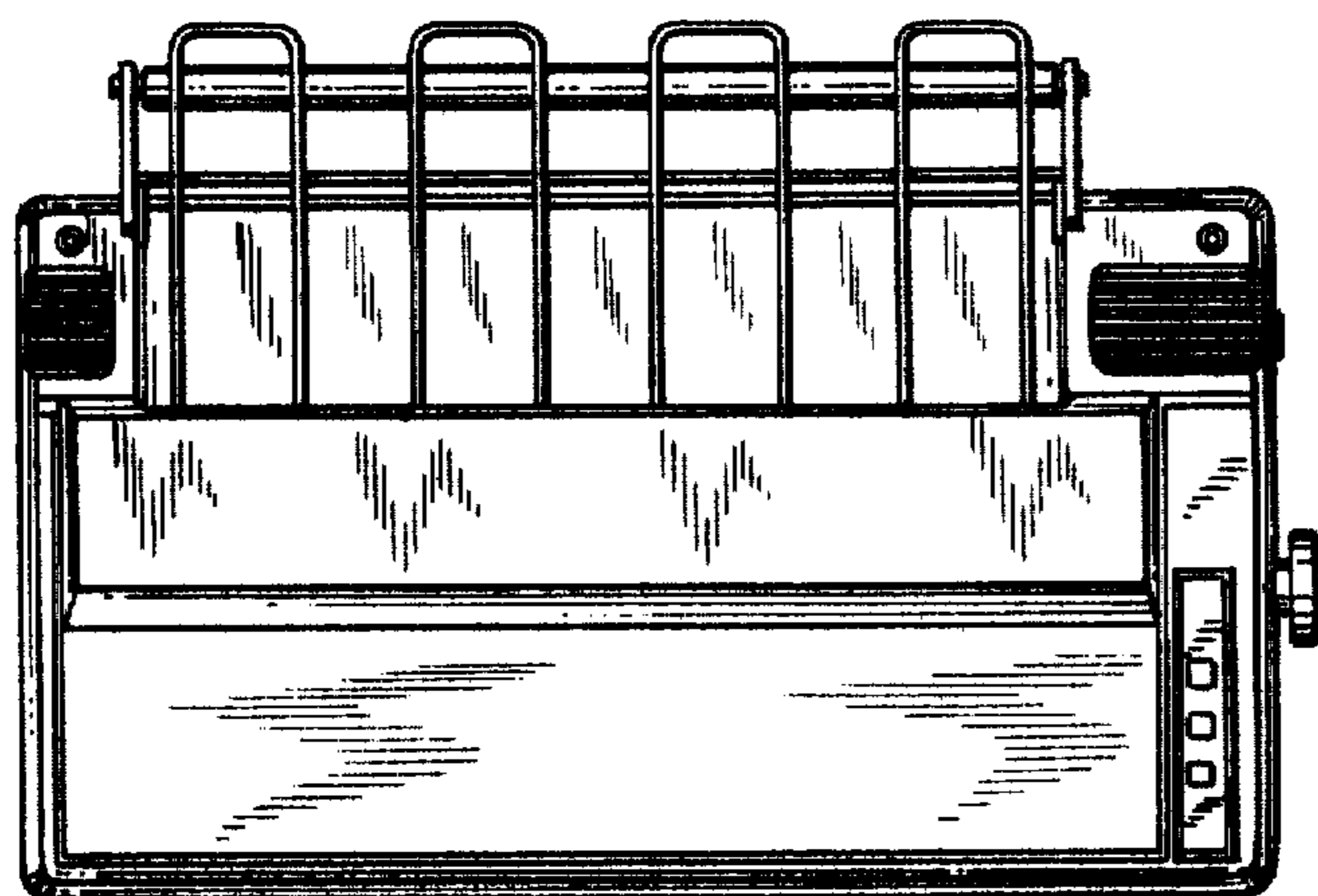
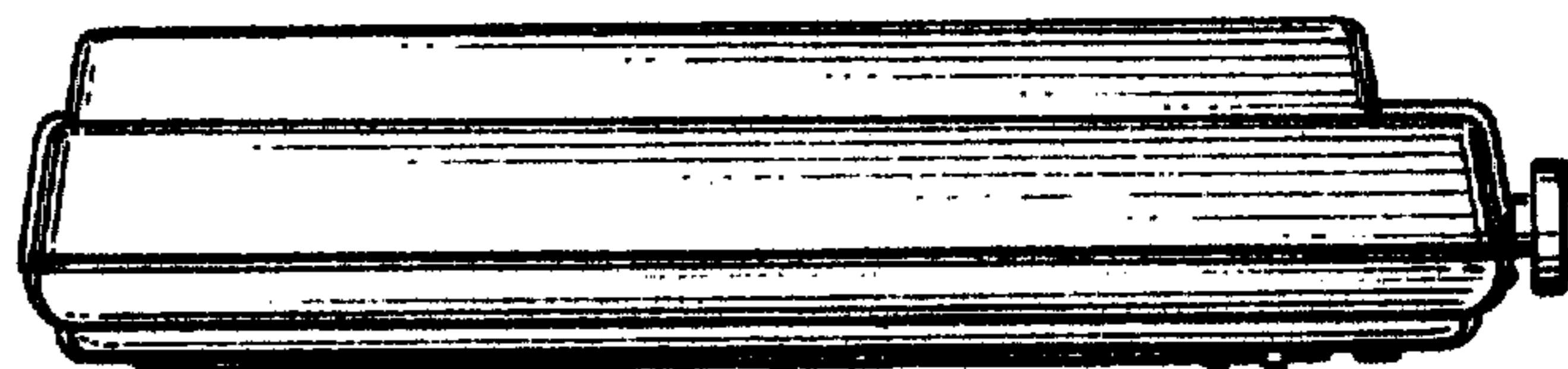

FIG. 2

FIG. 3

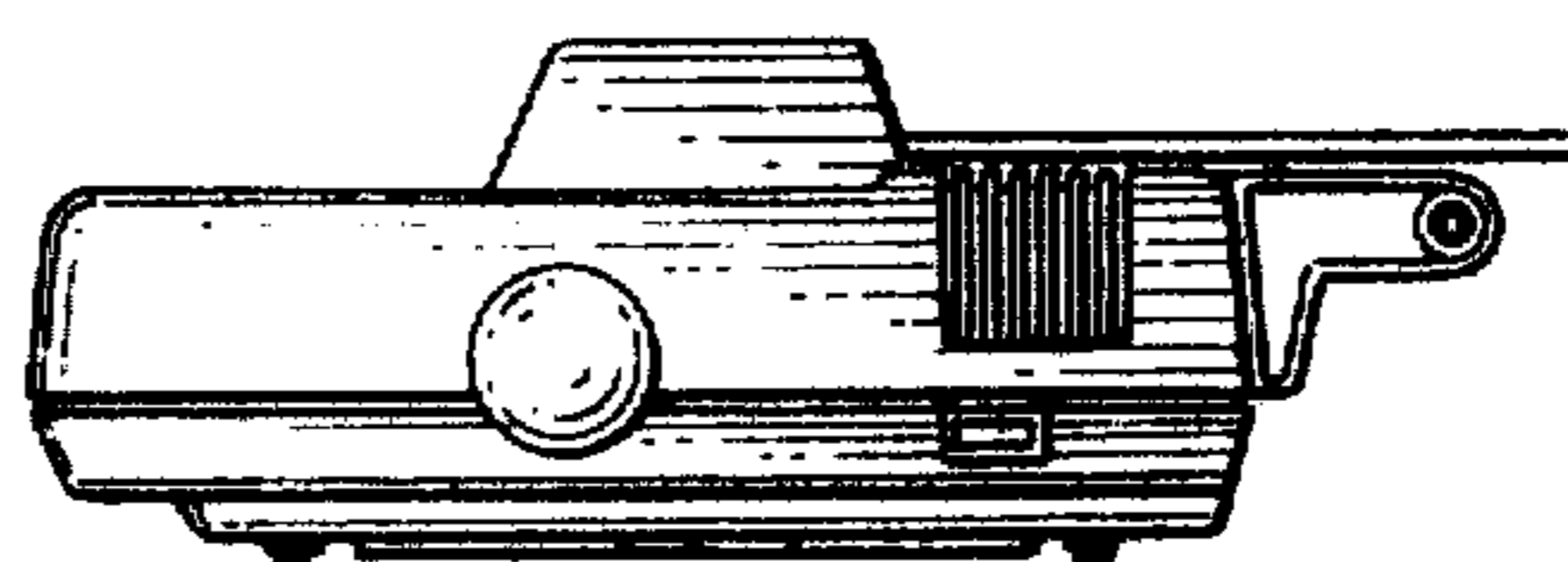

FIG. 4

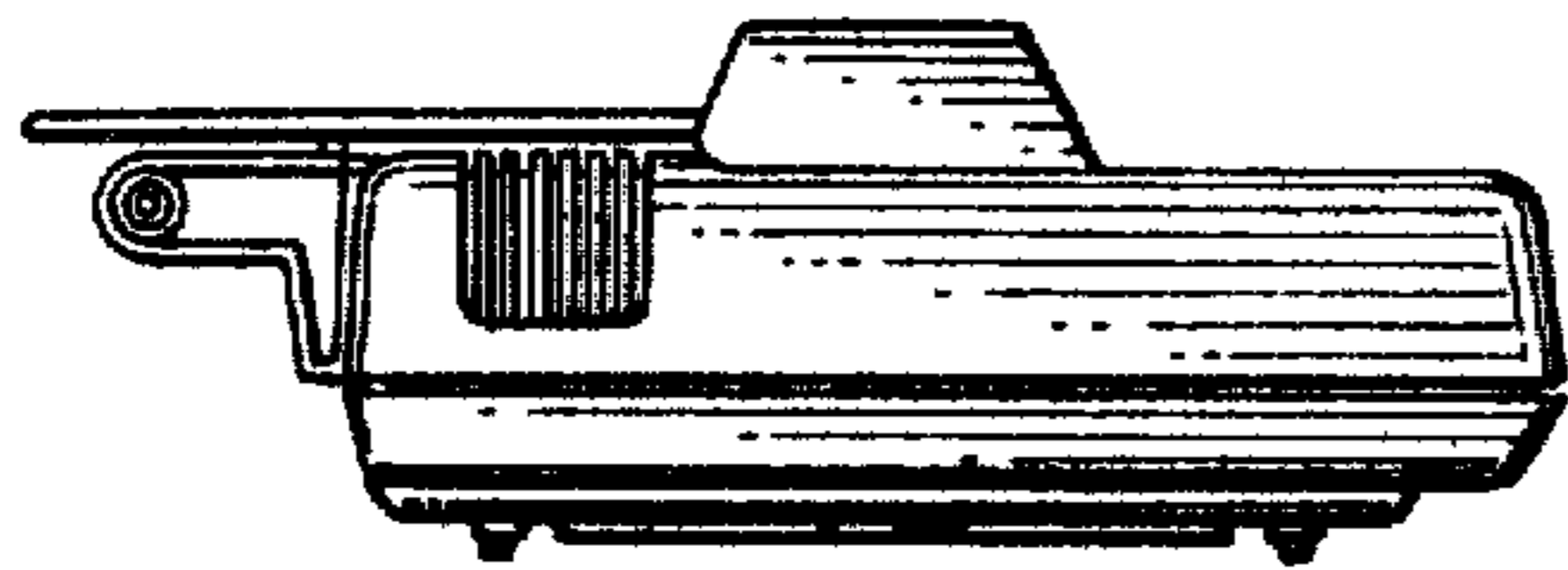

FIG. 5

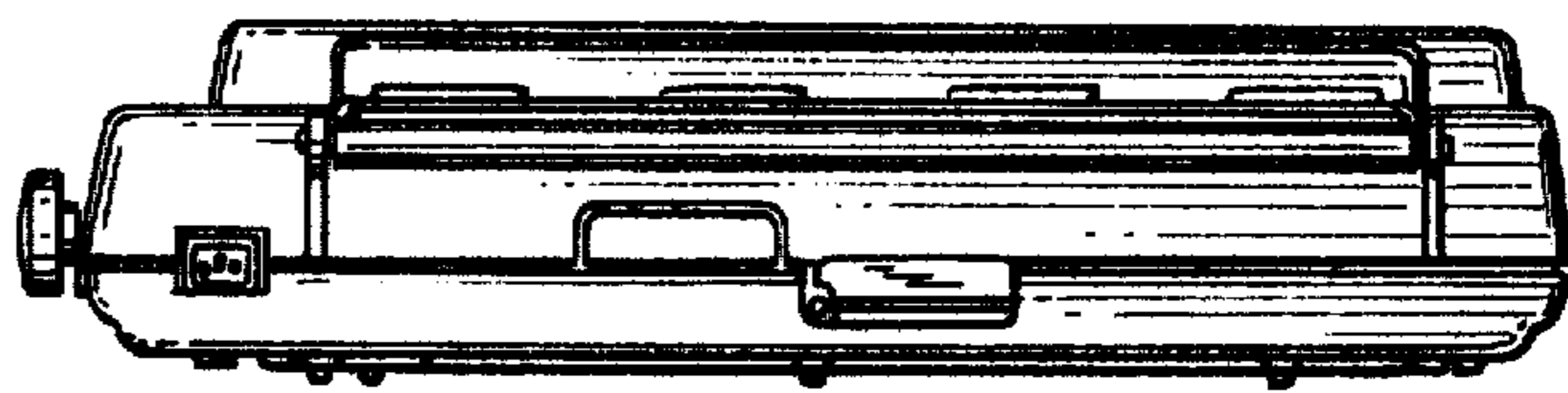

FIG. 6

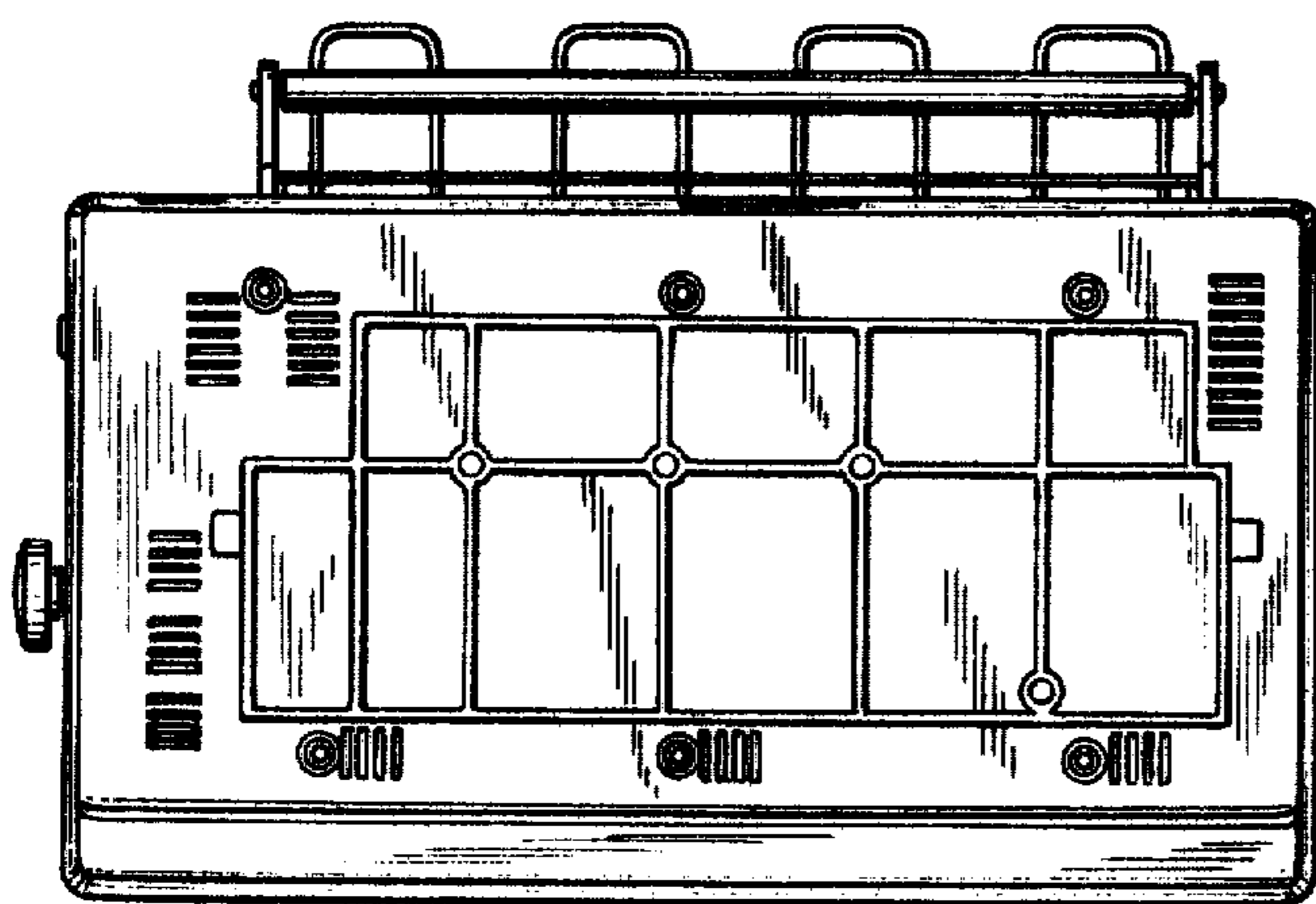

FIG. 7

