

[54] **JUG OR THE LIKE**  
 [75] **Inventor: Pieter K. J. DeCoster, Aalsta, Belgium**  
 [73] **Assignee: Dart Industries Inc.**  
 [\*\*] **Term: 14 Years**  
 [21] **Appl. No.: 334,286**  
 [22] **Filed: Dec. 24, 1981**  
 [51] **Int. Cl. .... D07-01**  
 [52] **U.S. Cl. .... D7/319; D7/312; D7/316**  
 [58] **Field of Search .... D7/50, 300-303, D7/312, 314, 316-322**

D. 255,531 6/1980 Daenen et al. .... D7/50 OR  
 D. 264,926 6/1982 McClelland .... D7/317 OR  
 D. 270,602 9/1983 Fritz .... D7/319 OR  
 3,844,450 10/1974 Johnson .... D7/317 X

*Primary Examiner—Winifred E. Herrmann*  
*Attorney, Agent, or Firm—Leigh B. Taylor*

[57] **CLAIM**

The ornamental design for a jug or the like, substantially as shown.

**DESCRIPTION**

FIG. 1 is a top perspective view of a jug or the like showing my new design;  
 FIG. 2 is a side elevational view thereof;  
 FIG. 3 is a top plan view thereof;  
 FIG. 4 is a one end elevational view thereof;  
 FIG. 5 is another end elevational view thereof;  
 FIG. 6 is a bottom plan view thereof; and  
 FIG. 7 is a cross-sectional view thereof taken along line 7-7 of FIG. 6.

[56] **References Cited**  
**U.S. PATENT DOCUMENTS**  
 D. 47,698 8/1915 Kuhn et al. .... D7/319 OR  
 D. 183,897 11/1958 Ostrowsky .... D7/319 OR  
 D. 227,143 6/1973 Haynes .... D7/317 OR  
 D. 239,428 4/1976 Cummings .... D7/318 OR

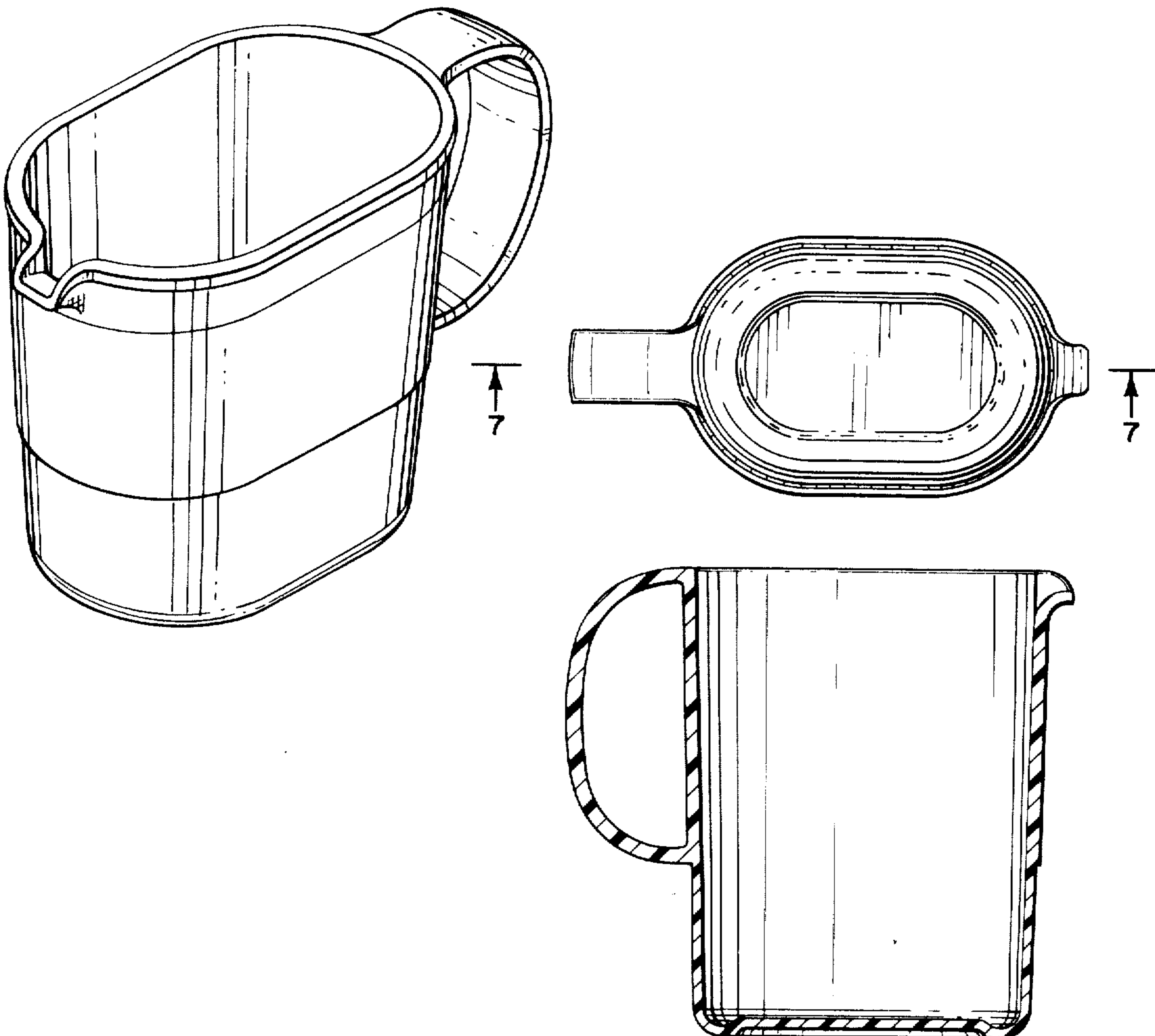

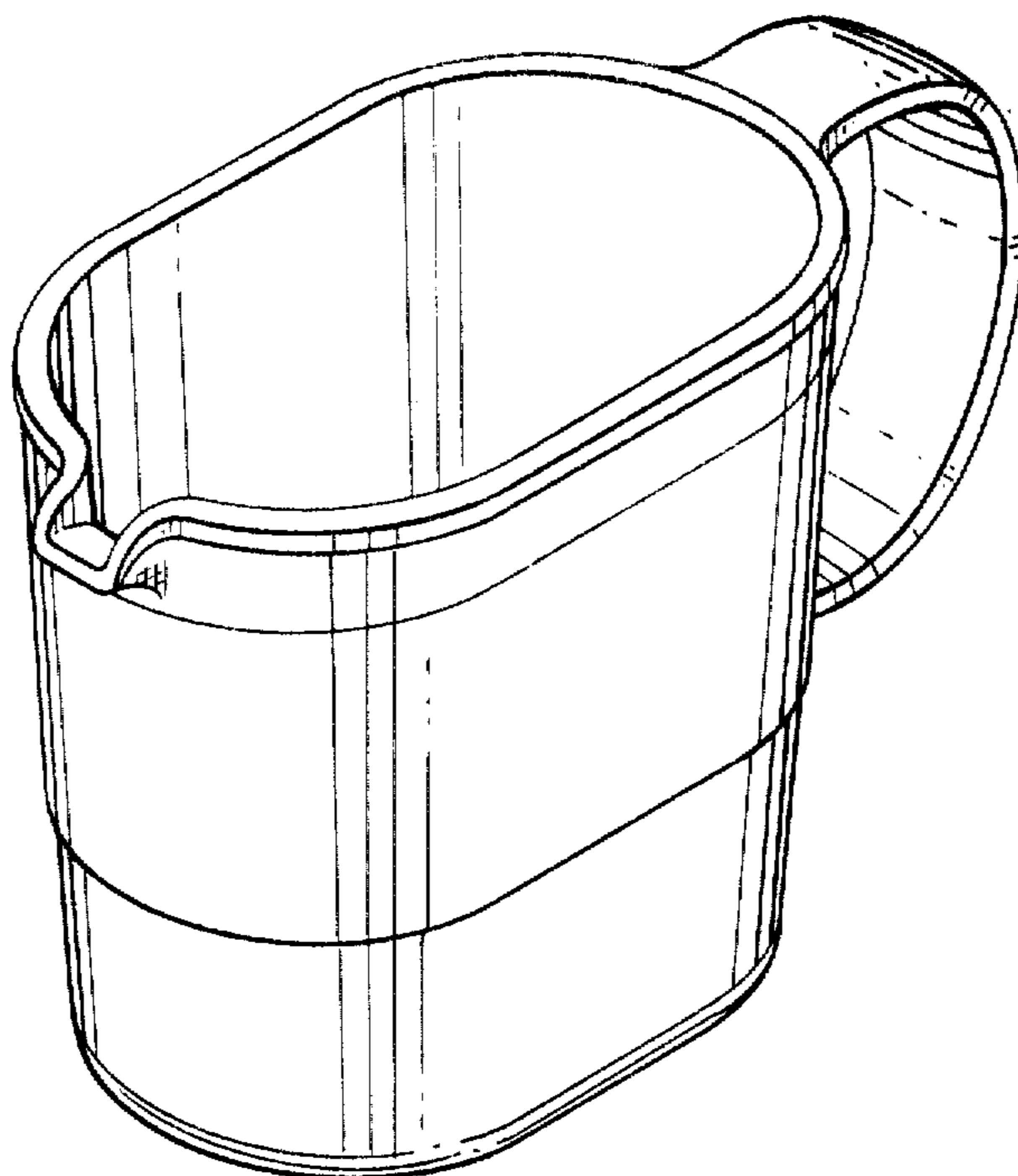

FIG. 1

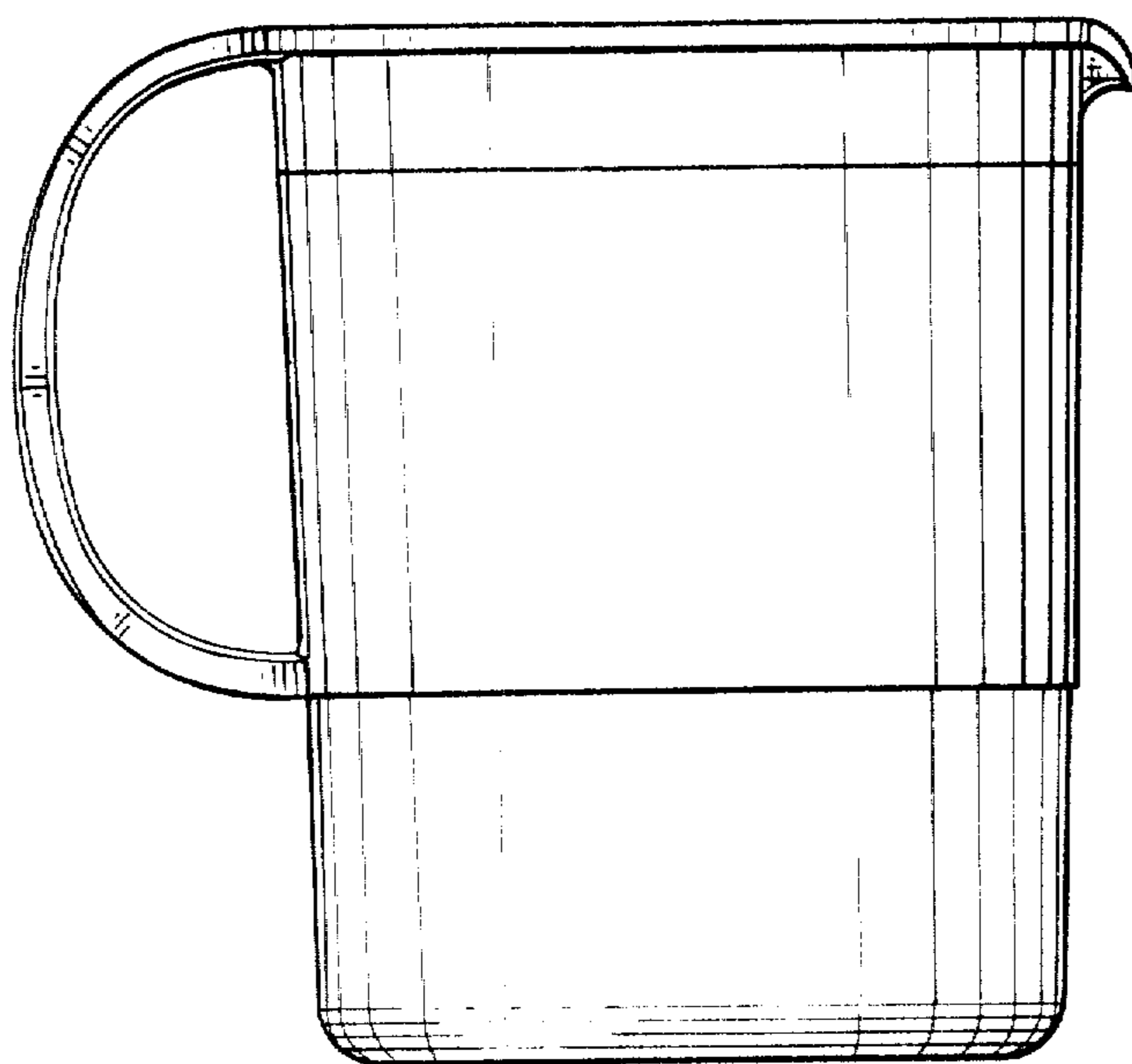

FIG. 2

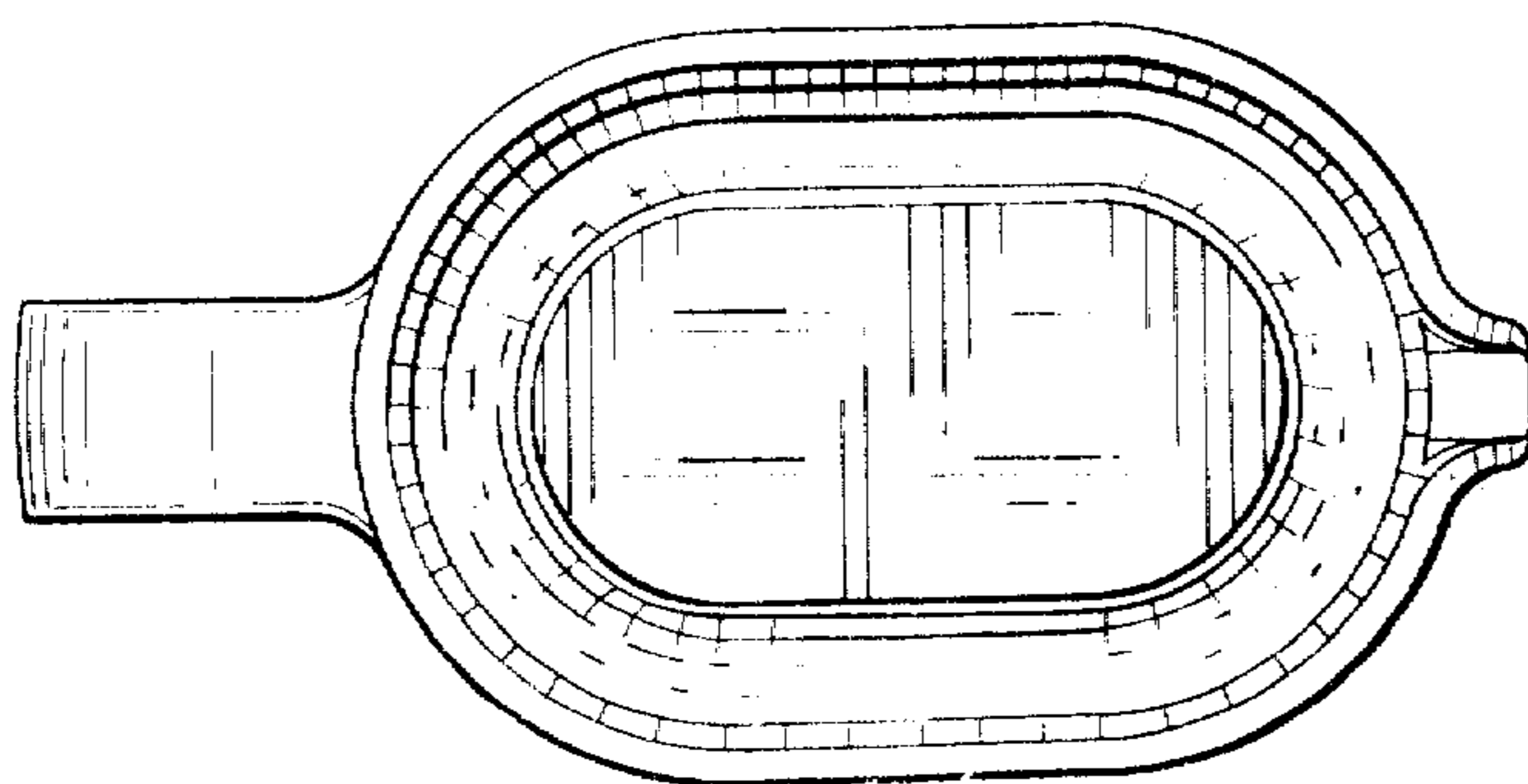

FIG. 3

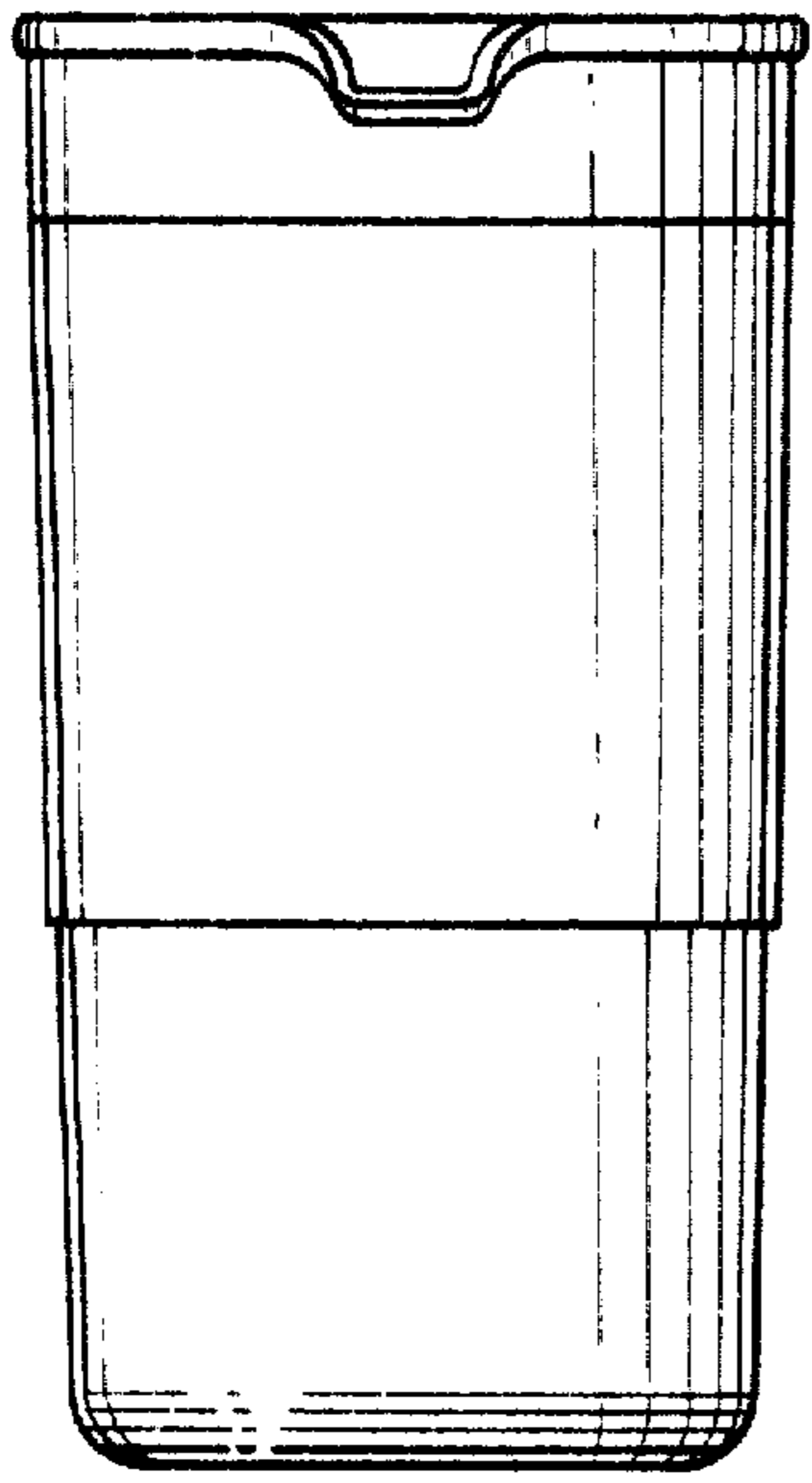

FIG. 4

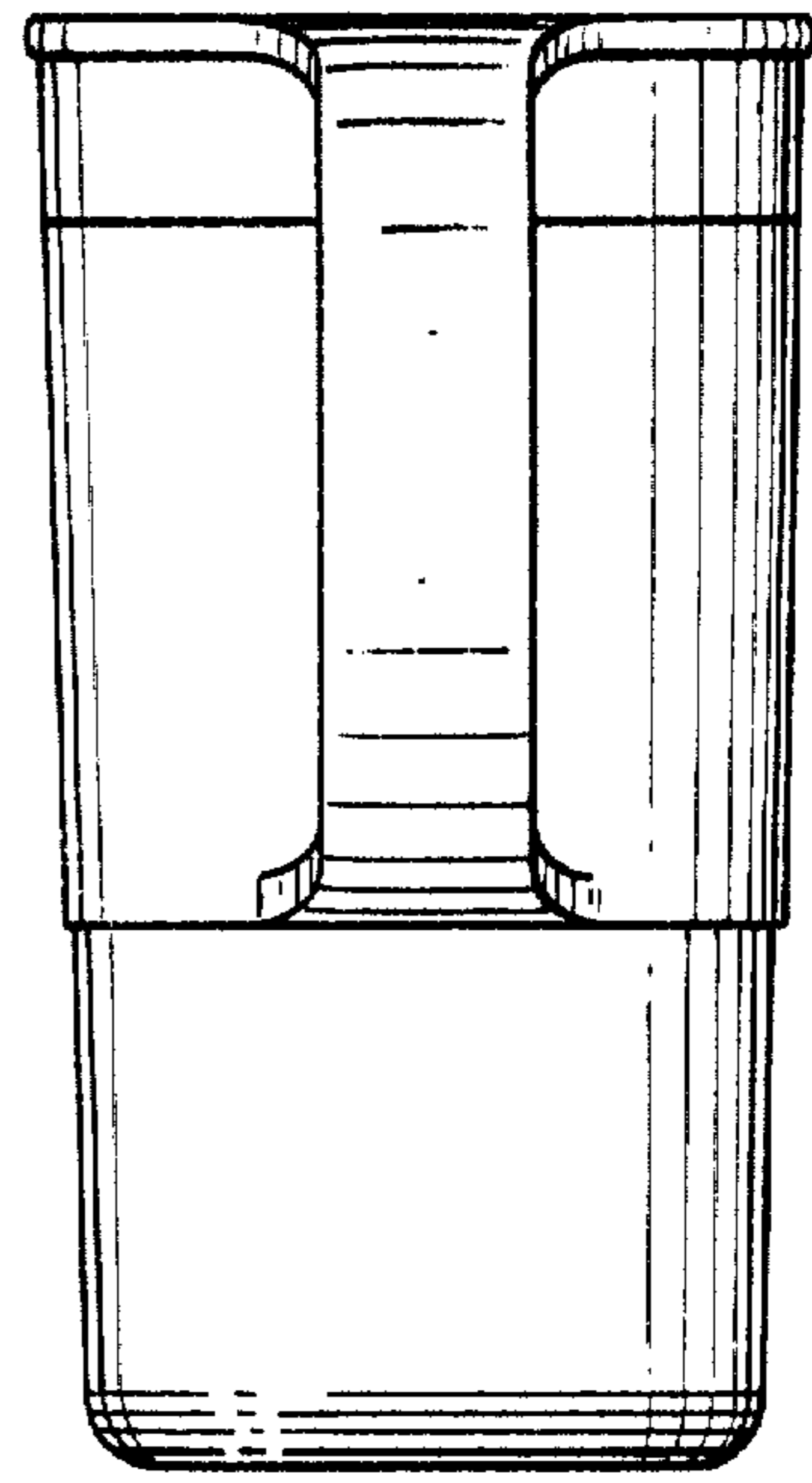

FIG. 5

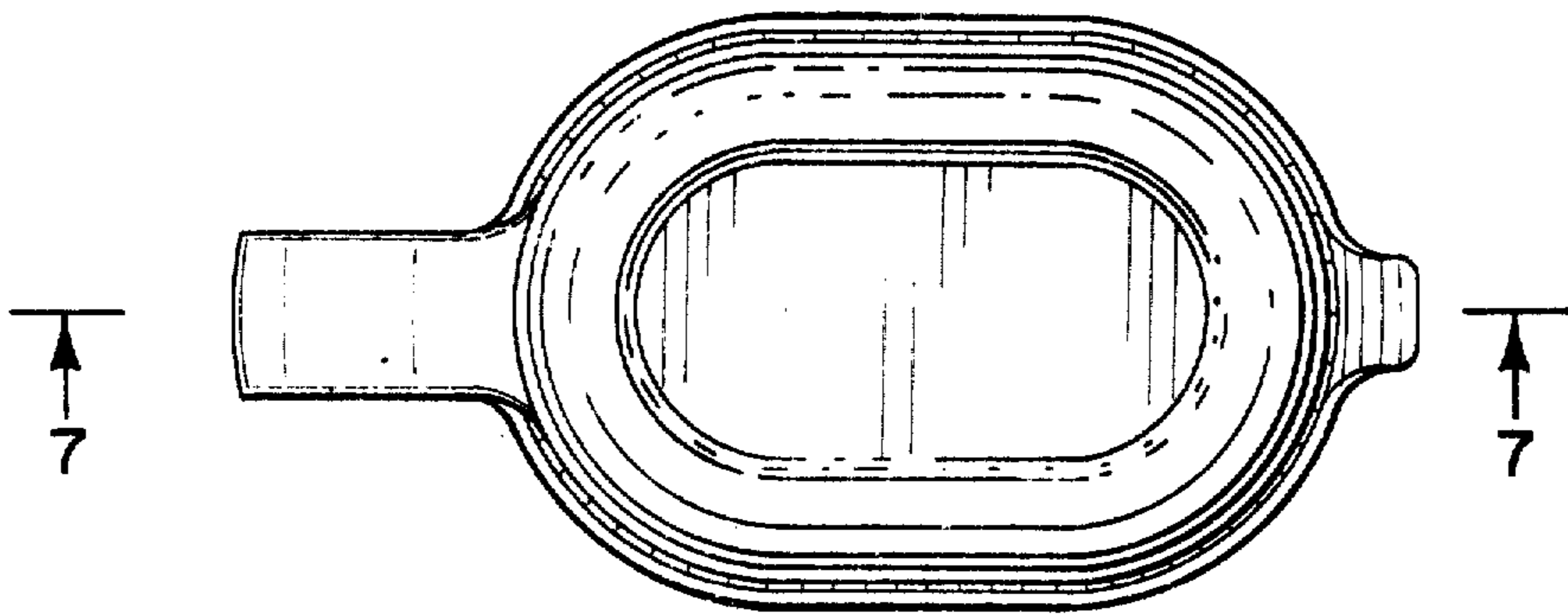

FIG. 6

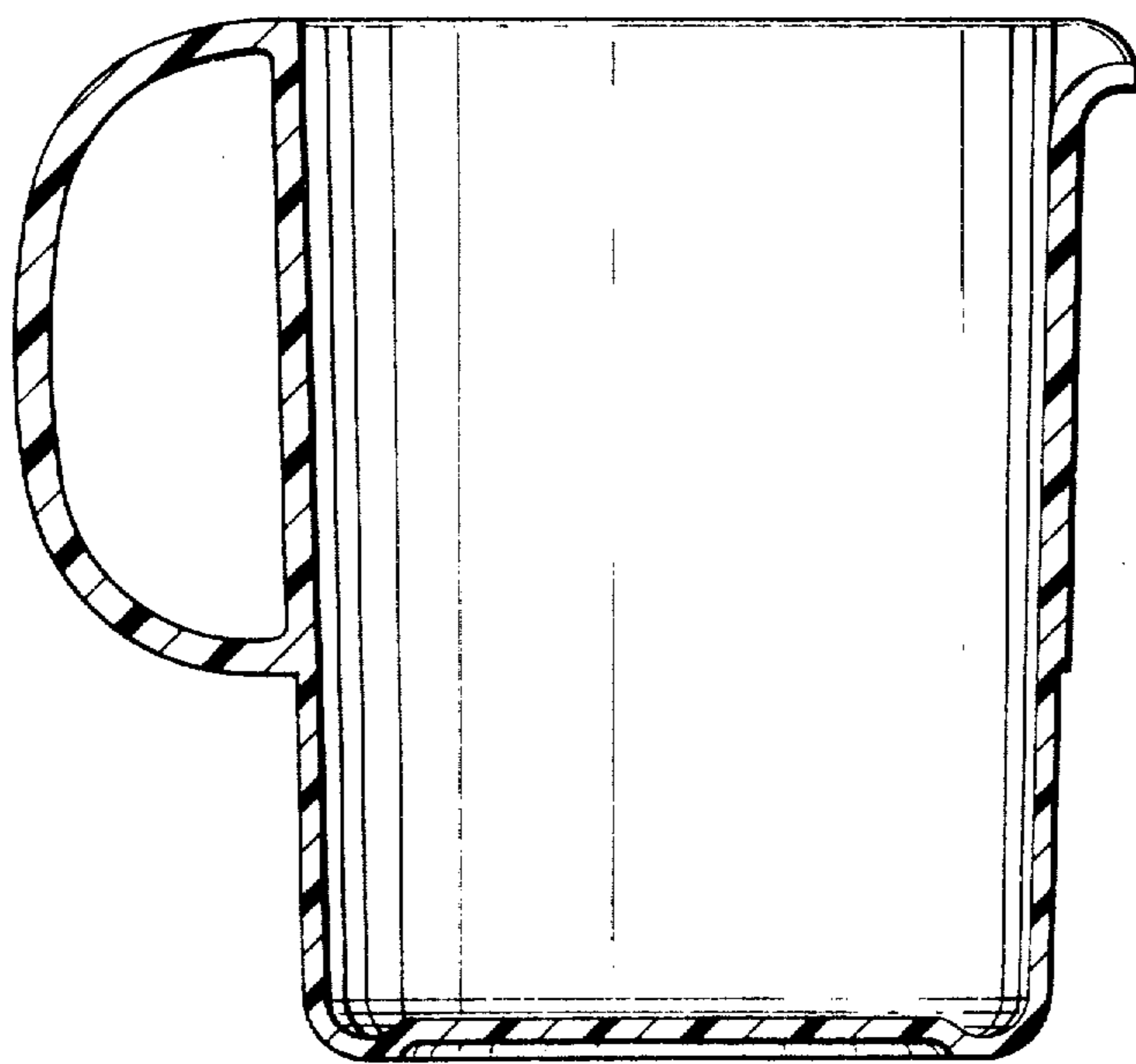

FIG. 7