

[54] TELEPHONE INDEX

[75] Inventor: Hans Halm, Herne, Fed. Rep. of Germany

[73] Assignee: Confon AG, Rheineck, Switzerland

[\*\*] Term: 14 Years

[21] Appl. No.: 241,365

[22] Filed: Mar. 6, 1981

[51] Int. Cl. .... D19-02

[52] U.S. Cl. .... D19/76; D19/87

[58] Field of Search .... D19/20-25, D19/75, 76, 86-89, 92; 40/371, 372, 375, 385, 390, 405; 281/15 B, 45; 209/610-613

[56] References Cited

U.S. PATENT DOCUMENTS

- D. 252,465 7/1979 Halm ..... D19/76
- D. 259,885 4/1981 Halm ..... D19/76

D. 262,120 12/1981 Halm ..... D19/76

Primary Examiner—George P. Word  
Attorney, Agent, or Firm—Toren, McGeady and Stanger

[57] CLAIM

The ornamental design for a telephone index, as shown and described.

DESCRIPTION

FIG. 1 is a perspective view of a telephone index showing my new design;  
 FIG. 2 is a perspective view similar to FIG. 1 with the drawer in the open position;  
 FIG. 3 is a top plan view thereof;  
 FIG. 4 is a front elevational view thereof;  
 FIG. 5 is a rear elevational view thereof;  
 FIG. 6 is a right side elevational view thereof;  
 FIG. 7 is a bottom plan view thereof; and  
 FIG. 8 is a perspective view similar to FIG. 2 with the drawer in the open position, however, illustrating the index card corresponding to one of the buttons.

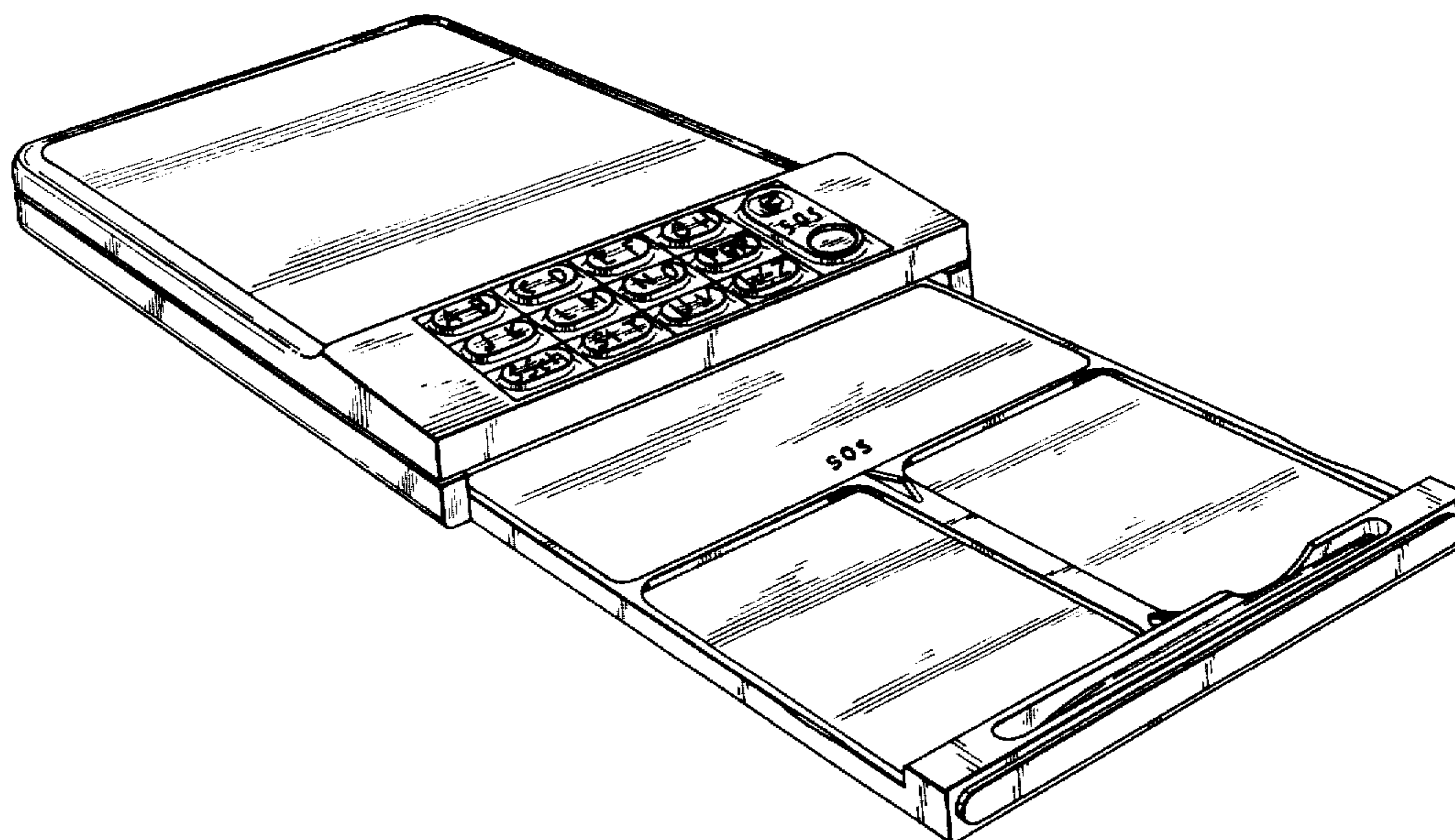

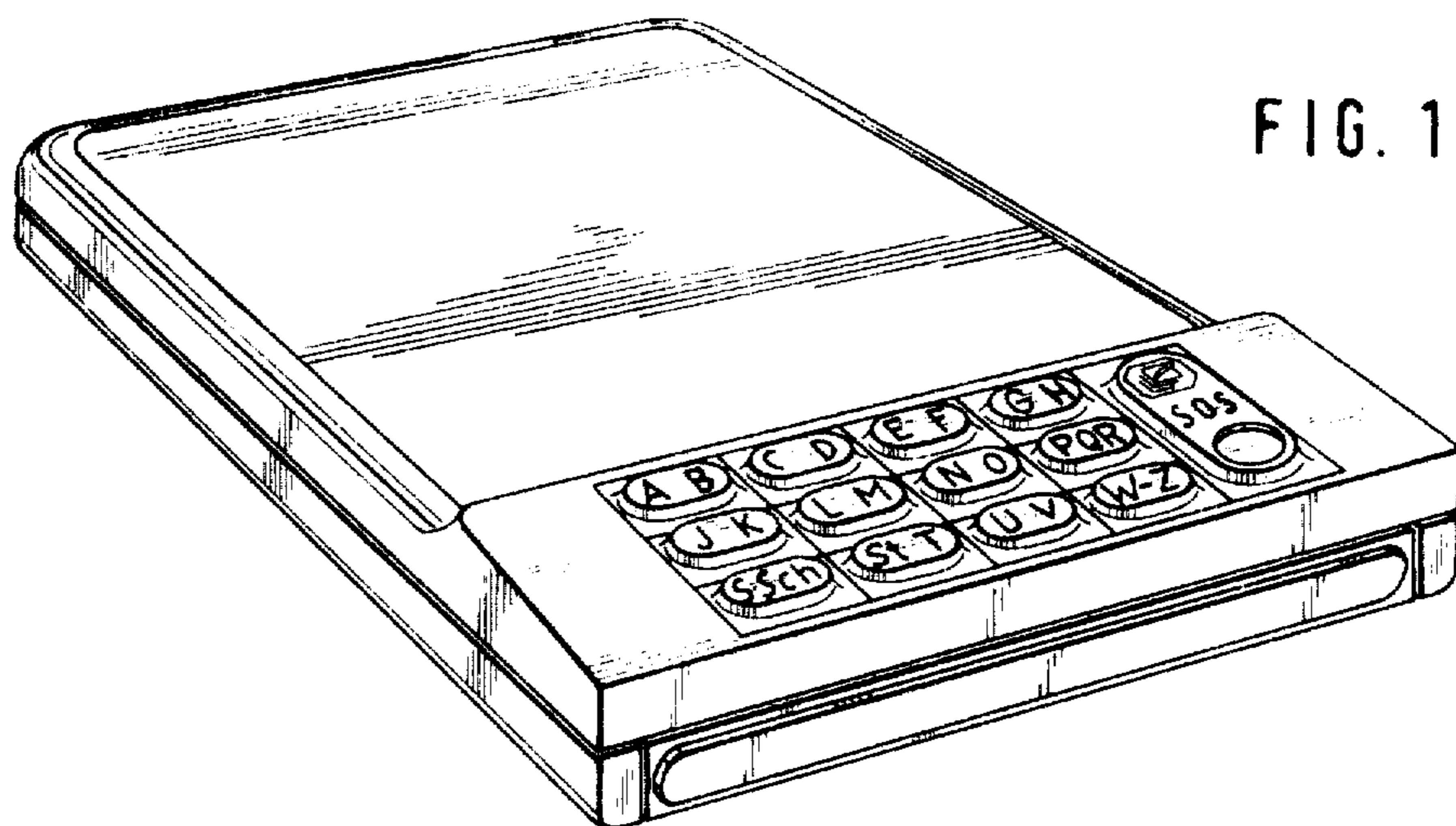

FIG. 1

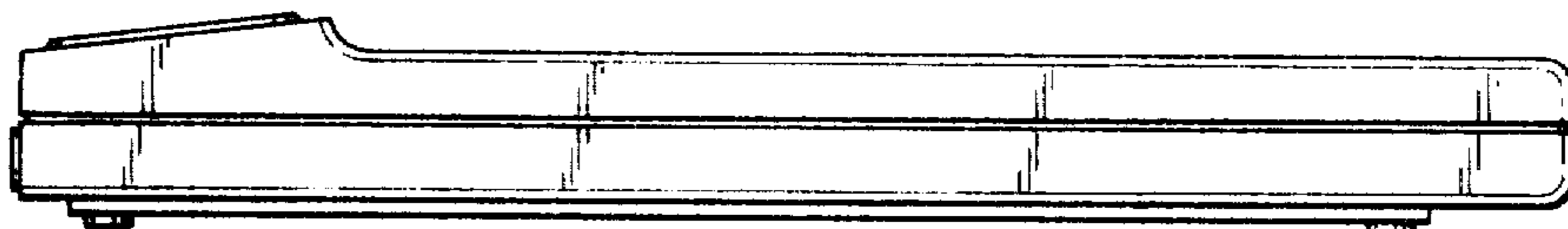

FIG. 6

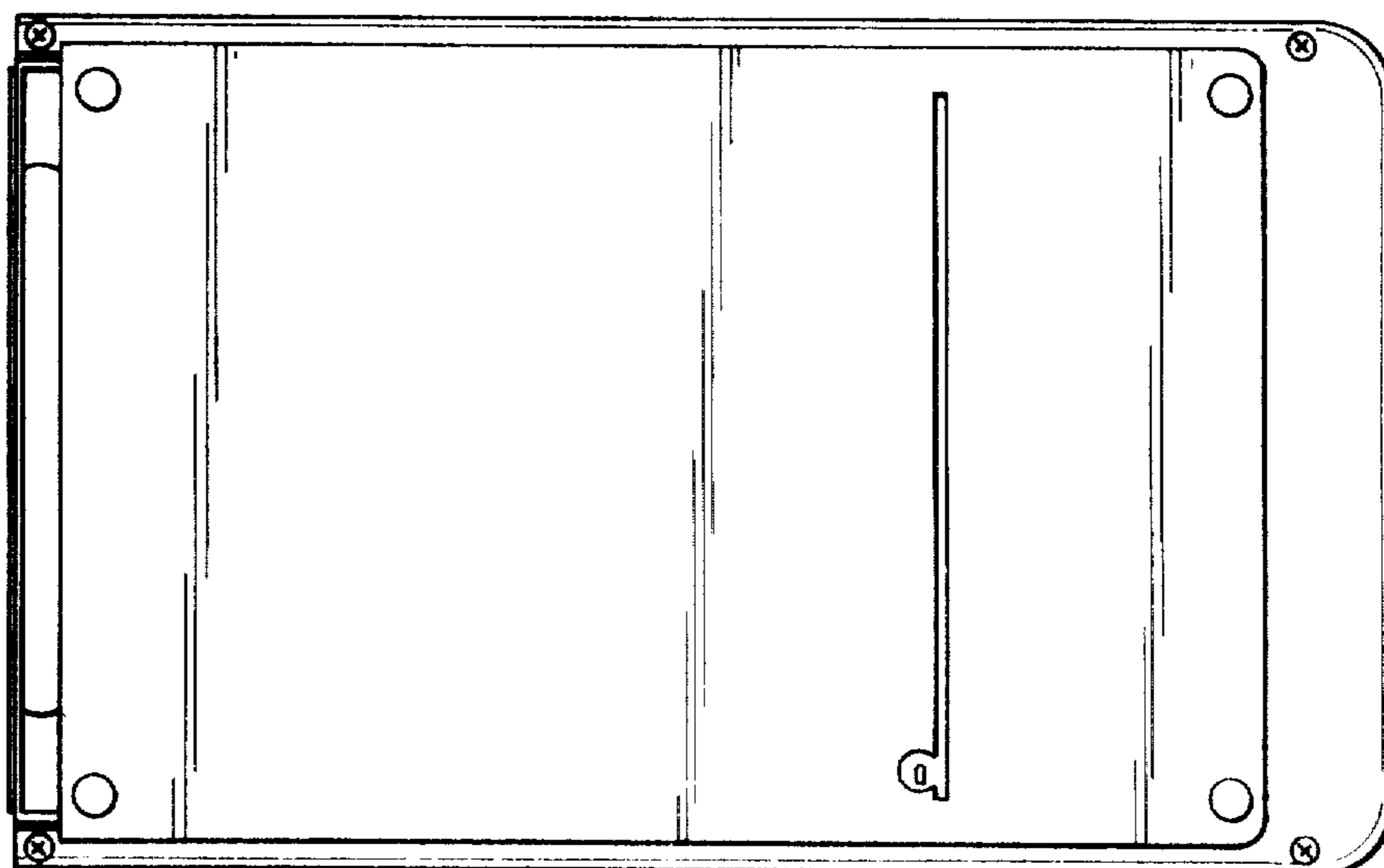

FIG. 7

FIG. 2

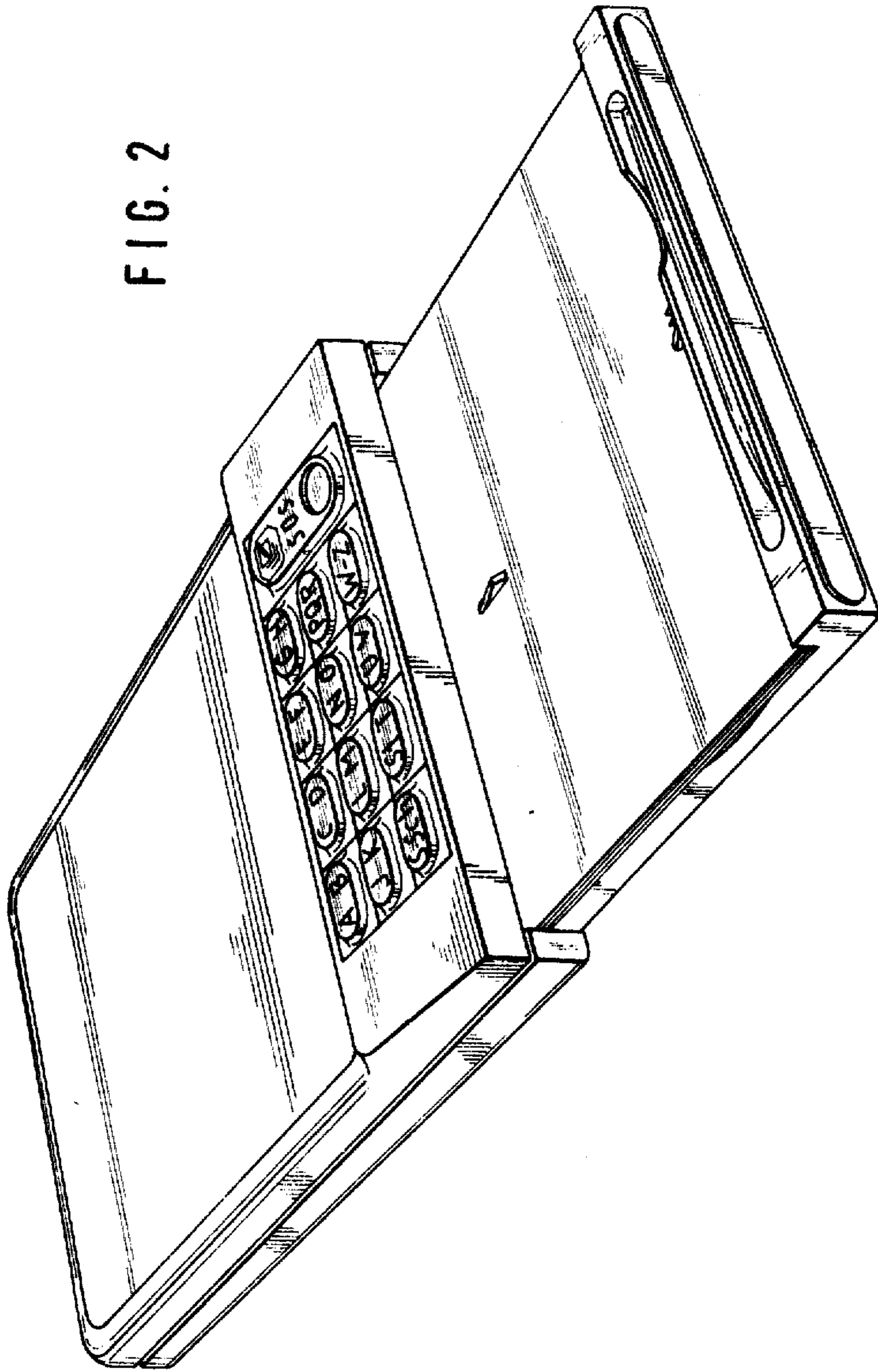

FIG. 3

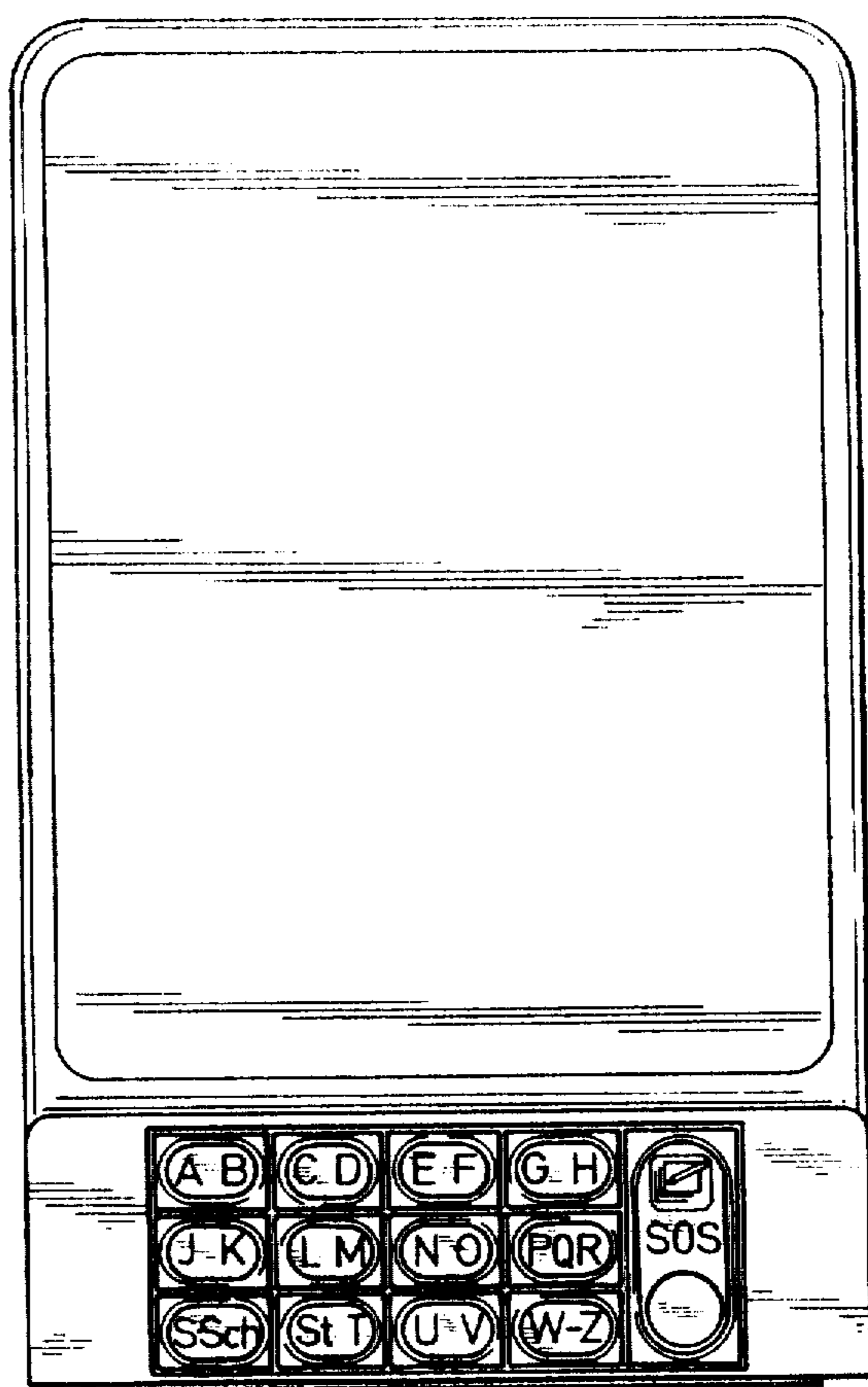

FIG. 4

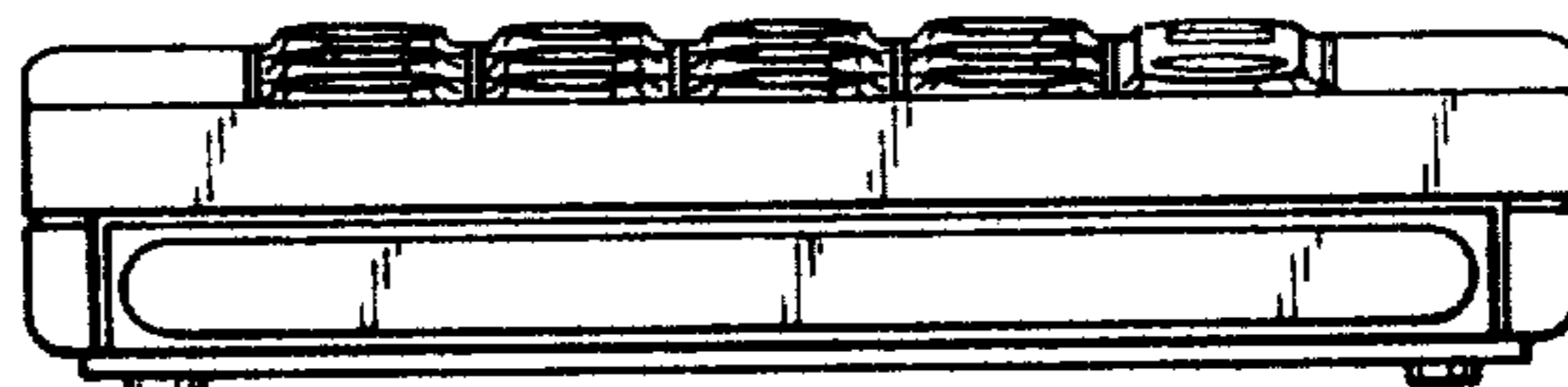

FIG. 5

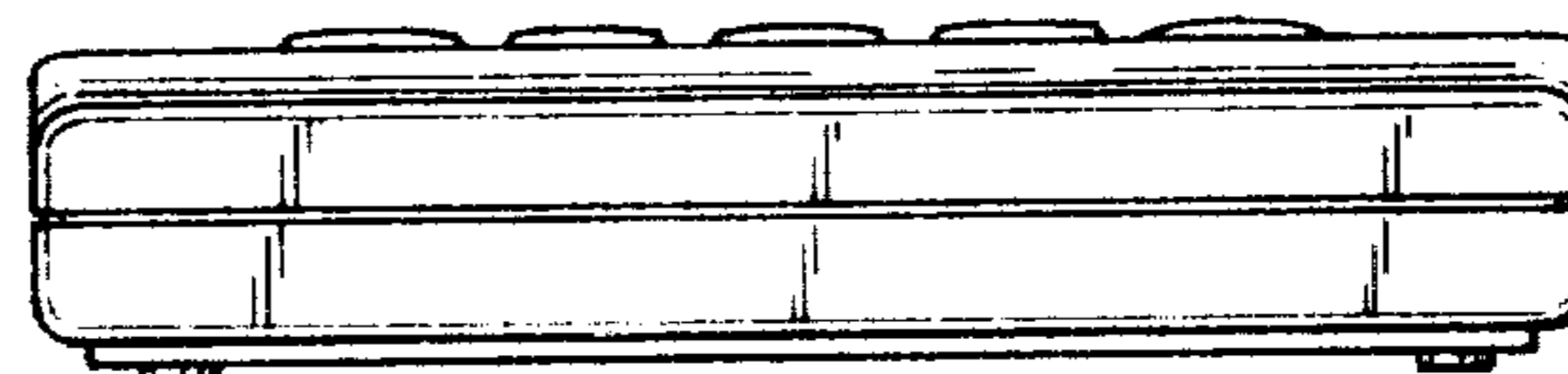

FIG. 8

