

[54] COMBINED TELEPHONE HANDSET AND BASE THEREFORE

[75] Inventors: John C. Coons; Jean M. Beirise, both of Cincinnati, Ohio

[73] Assignee: Masco Corporation of Indiana, Taylor, Mich.

[\*\*] Term: 14 Years

[21] Appl. No.: 259,617

[22] Filed: May 1, 1981

[51] Int. Cl. .... D14-03

[52] U.S. Cl. .... D14/53; D14/58; D14/60

[58] Field of Search ..... D14/53, 58, 60; 179/100 D, 100 R, 103, 178, 179, 92, 95

[56] References Cited

U.S. PATENT DOCUMENTS

- D. 237,893 12/1975 Wennerström ..... D14/95 X
- D. 263,045 2/1982 Janda et al. .... D14/53
- D. 263,046 2/1982 Genaro et al. .... D14/53

- D. 266,763 11/1982 Grae ..... D14/53
- D. 267,178 12/1982 Mona ..... D14/53
- D. 267,317 12/1982 Fukushima et al. .... D14/53
- 4,178,488 12/1979 Nishihata ..... 179/103

Primary Examiner—Bernard Ansher  
Attorney, Agent, or Firm—Steven L. Permut; E. Dennis O'Connor; Leon E. Redman

[57] CLAIM

The ornamental design for a combined telephone handset and base therefore, as shown and described.

DESCRIPTION

FIG. 1 is a front perspective view of a combined telephone handset and base therefore showing our new design;  
 FIG. 2 is a top plan view thereof;  
 FIG. 3 is a right side elevational view thereof;  
 FIG. 4 is a left side elevational view thereof;  
 FIG. 5 is a rear elevational view thereof;  
 FIG. 6 is a front elevational view thereof;  
 FIG. 7 is a bottom elevational view thereof;  
 FIG. 8 is a fragmentary rear elevational view thereof with the antenna broken away in a raised position.

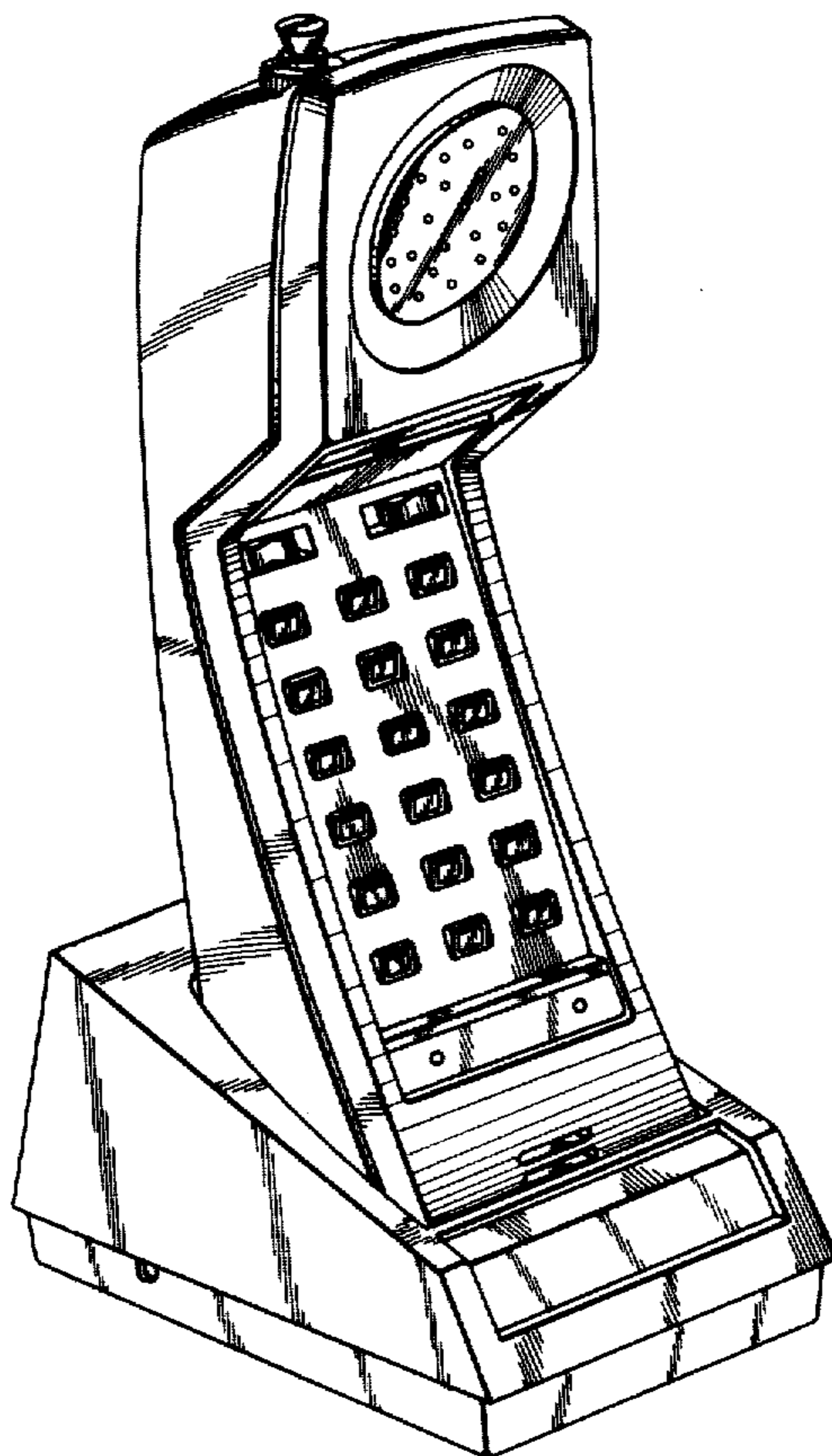

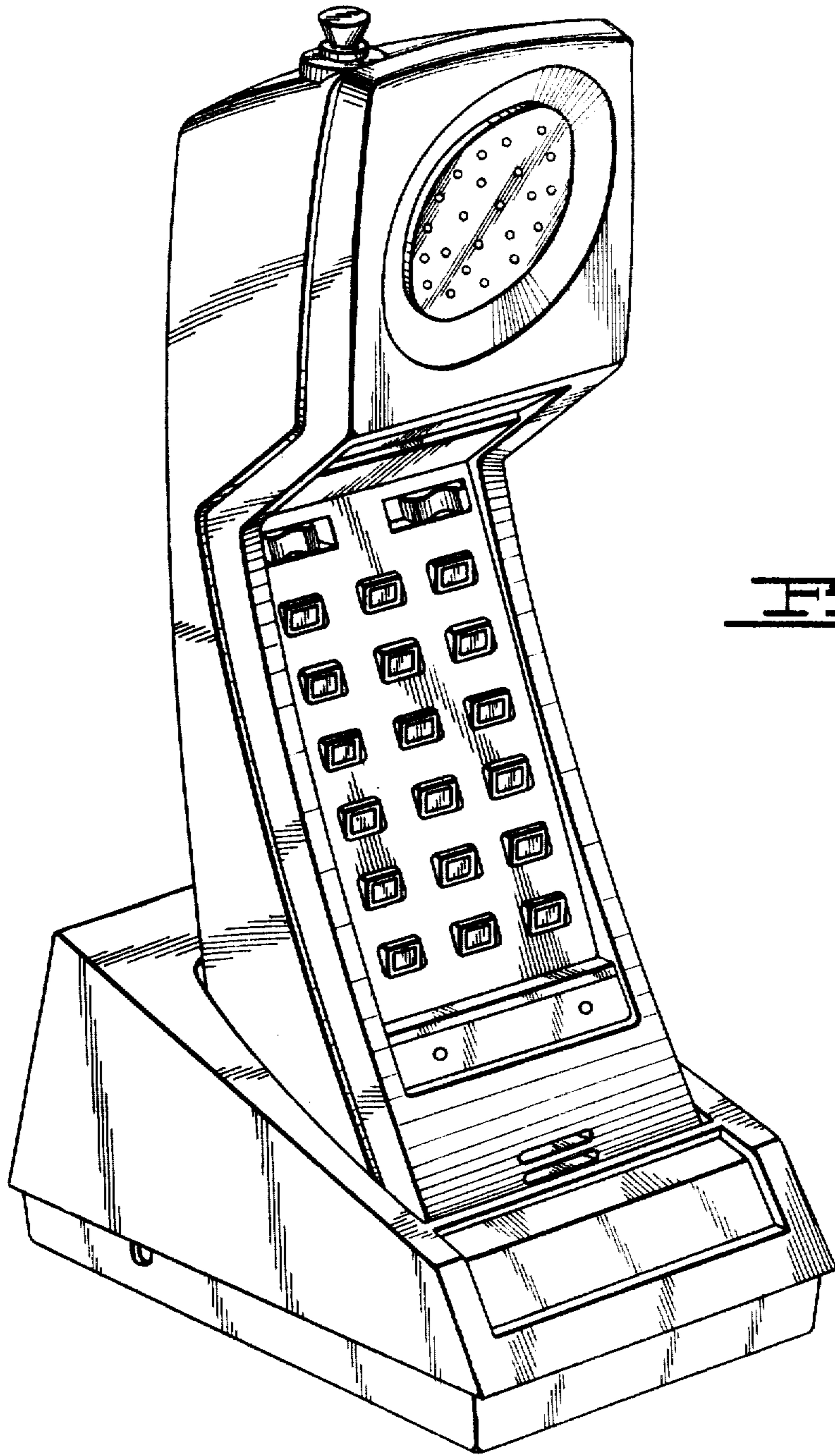
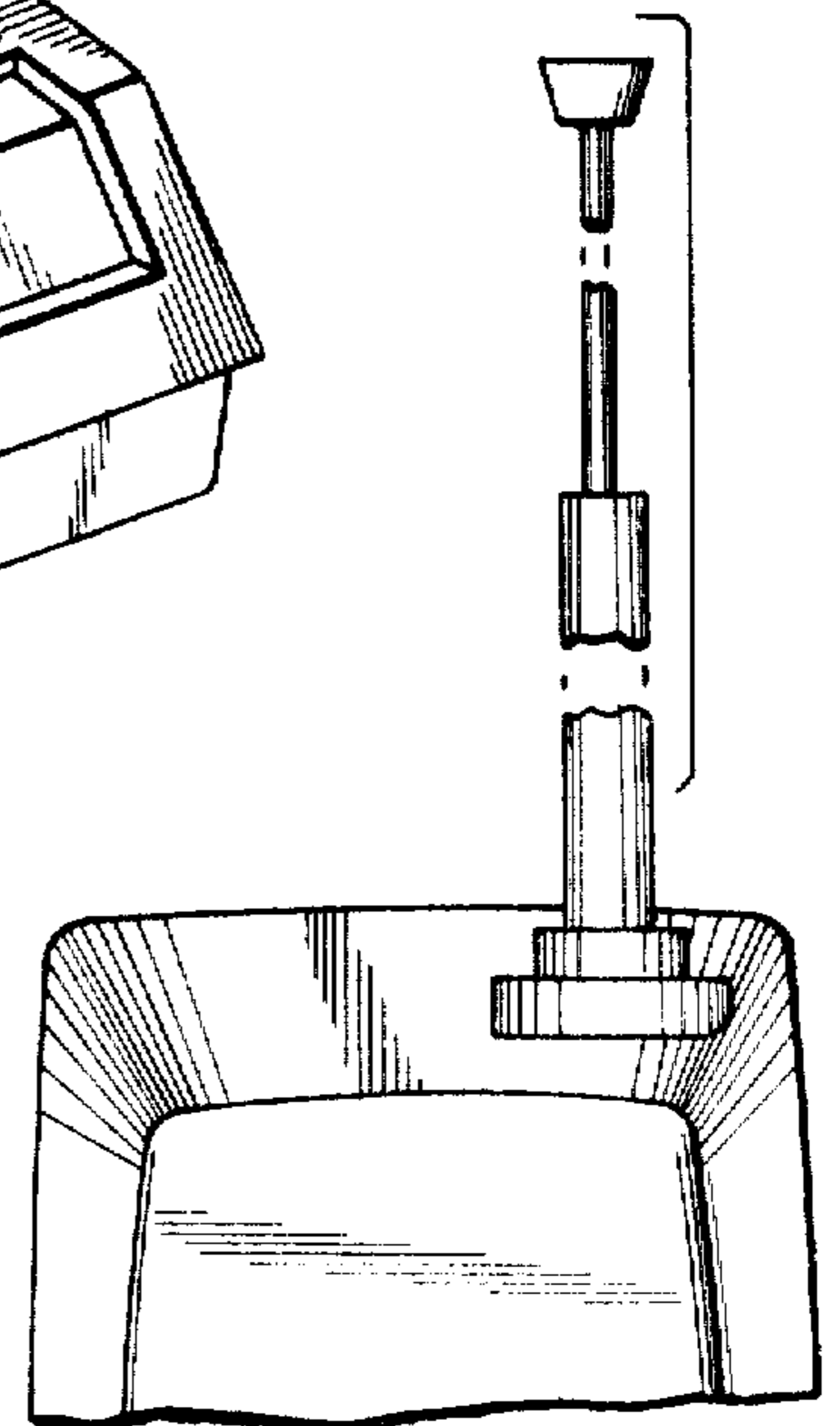

FIG. 1.



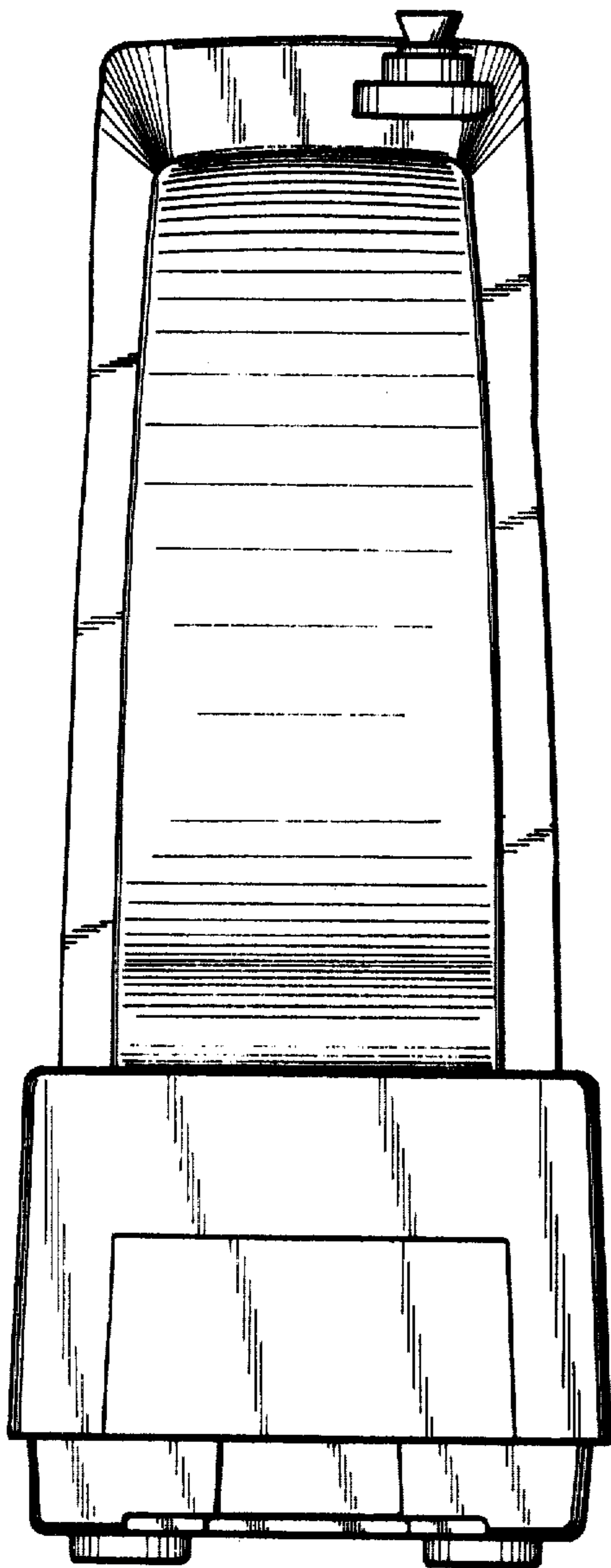

FIG. 5.

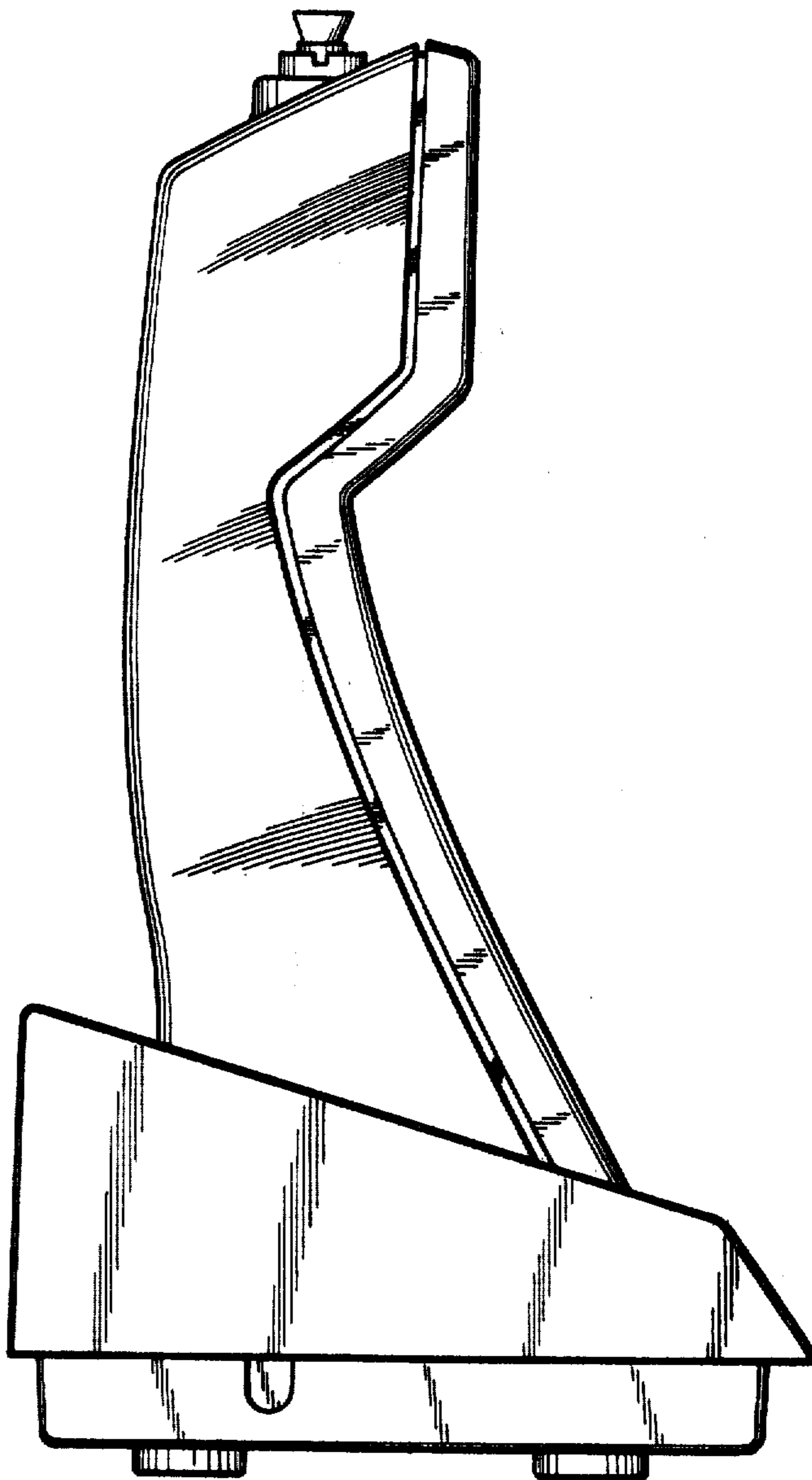
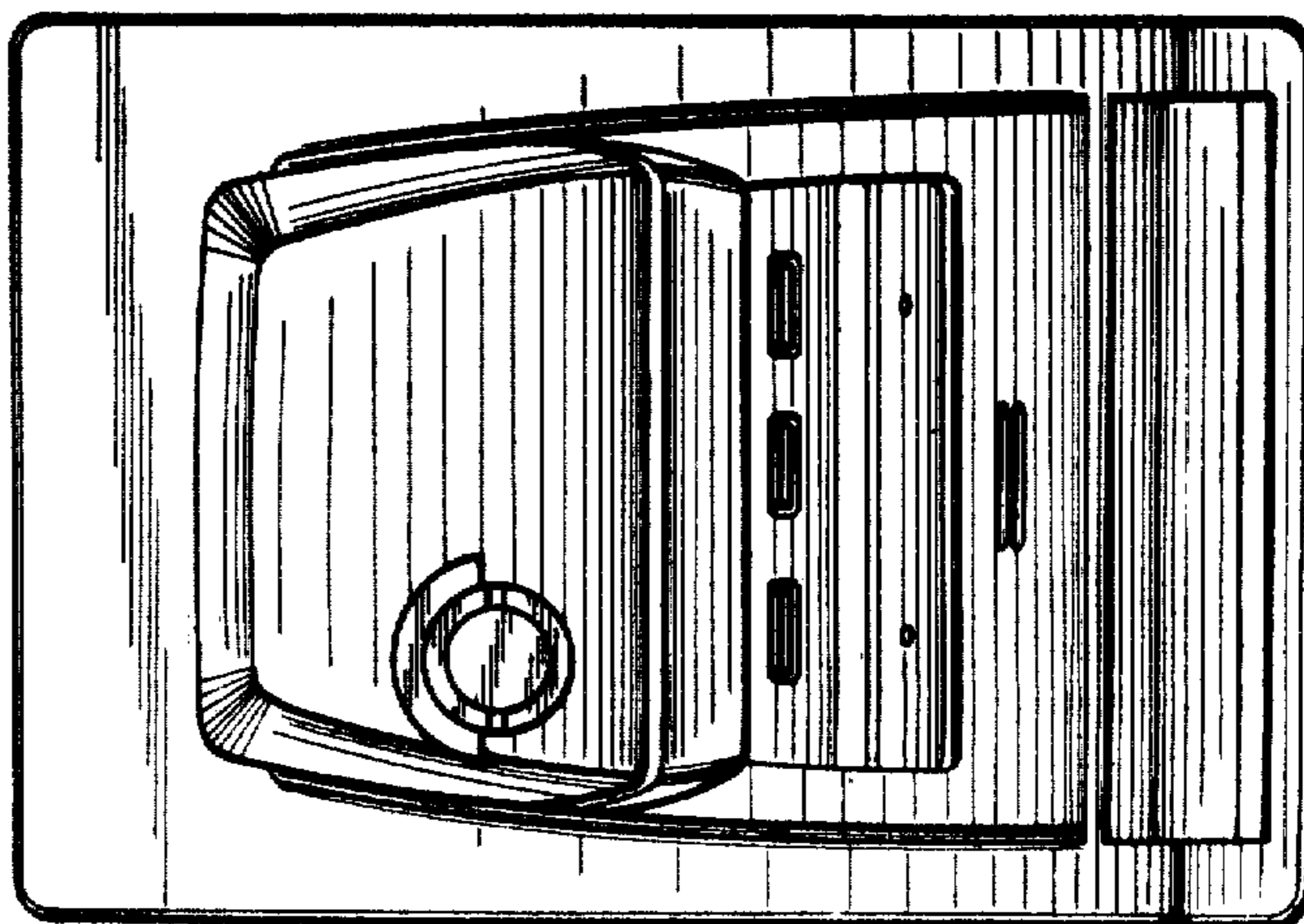

FIG. 3.

FIG. 2.





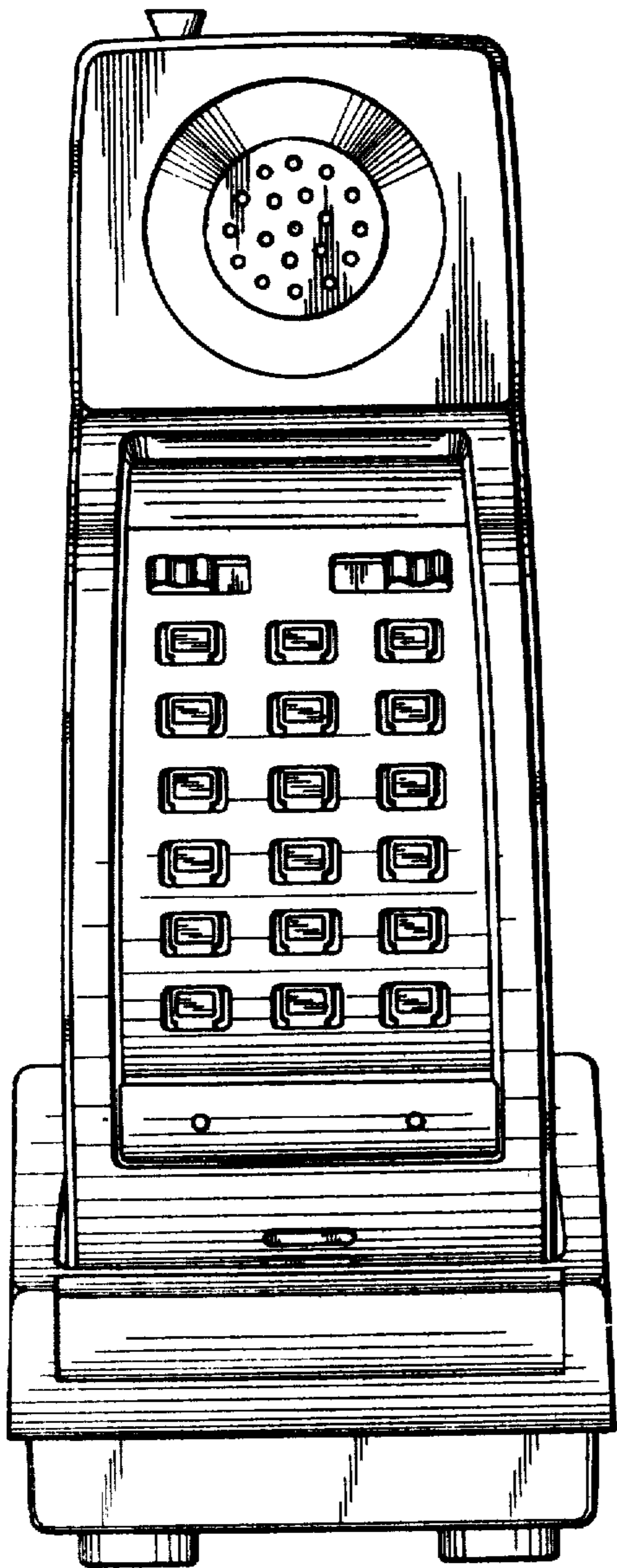

FIG. 5.

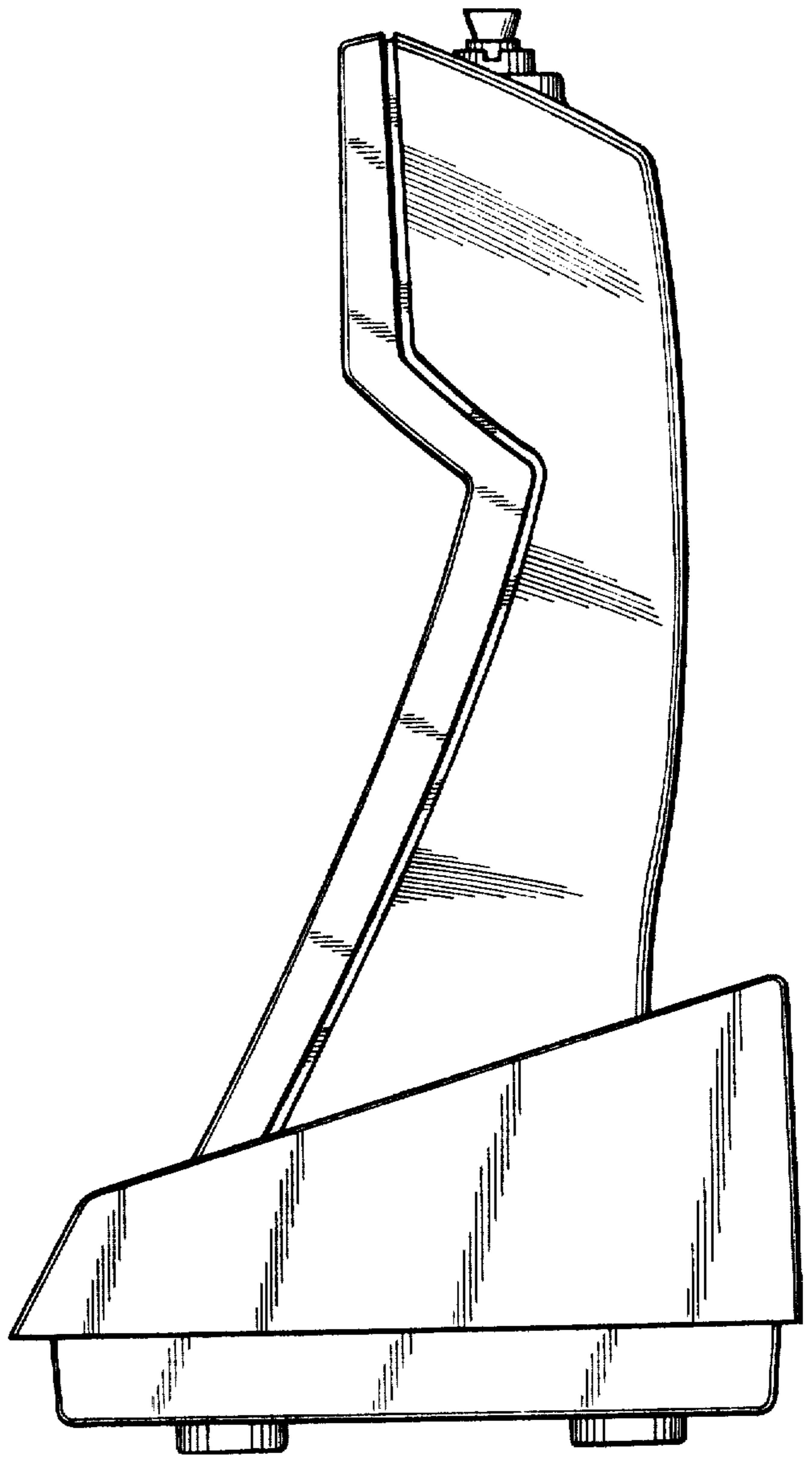

FIG. 4.

FIG. 7.

