

[54] **MOTORCYCLE**

[75] Inventors: **Minoru Morioka, Kawagoe; Mamoru Matsui, Tokyo; Michihiko Yasuda, Fujimi, all of Japan**

[73] Assignee: **Honda Giken Kogyo Kabushiki Kaisha, Tokyo, Japan**

[\*\*] Term: **14 Years**

[21] Appl. No.: **187,983**

[22] Filed: **Sep. 16, 1980**

[30] **Foreign Application Priority Data**

Mar. 19, 1980 [JP] Japan ..... 55-10933

[51] Int. Cl. .... **D12-11**

[52] U.S. Cl. .... **D12/110**

[58] Field of Search ..... **D12/110; 180/219**

[56] **References Cited**  
**PUBLICATIONS**

Cycle World, 9/79, p. 49, Suzuki GS 1000.  
Cycle World, 8/79, p. 16, Yamaha, bottom center of page.

*Primary Examiner*—James M. Gandy  
*Attorney, Agent, or Firm*—Armstrong, Nikaido, Marmelstein & Kubovcik

[57] **CLAIM**

The ornamental design for a motorcycle, as shown and described.

**DESCRIPTION**

FIG. 1 is a left side elevational view of a motorcycle showing our new design;  
FIG. 2 is a right side elevational view thereof;  
FIG. 3 is a front elevational view thereof;  
FIG. 4 is a rear elevational view thereof;  
FIG. 5 is a top plan view thereof;  
FIG. 6 is a bottom plan view thereof; and  
FIG. 7 is a perspective view thereof.

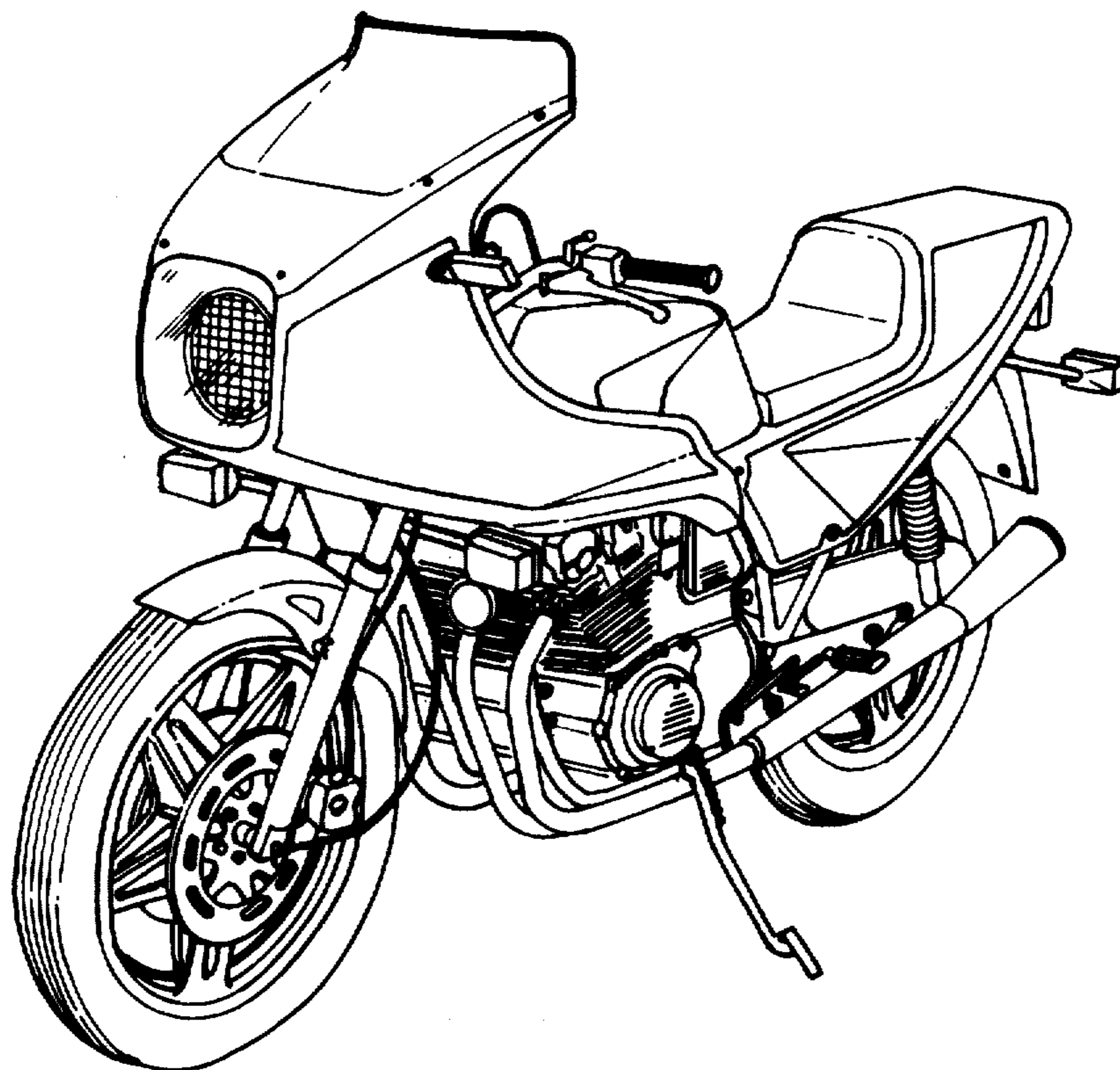

FIG. 1

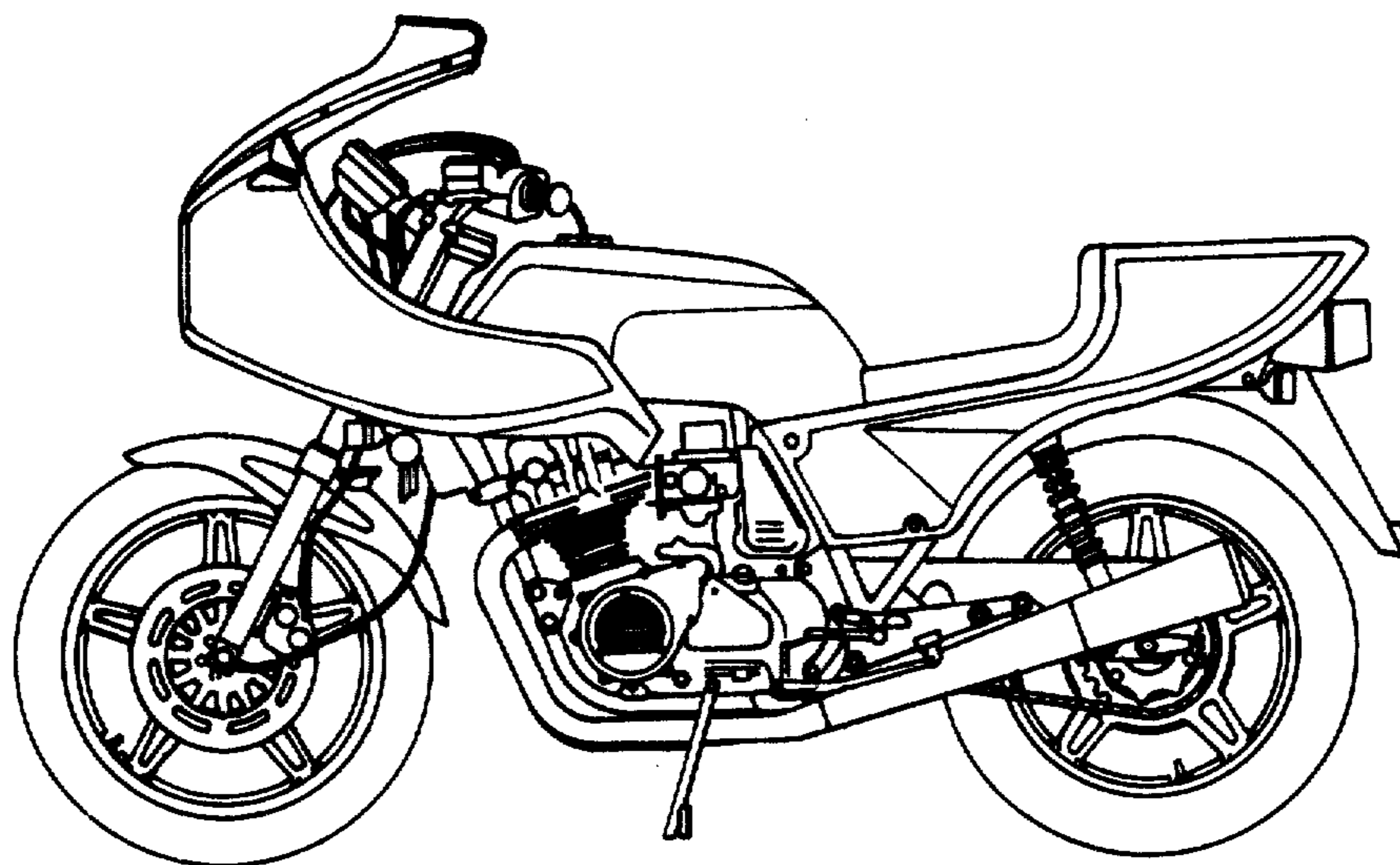

FIG. 2

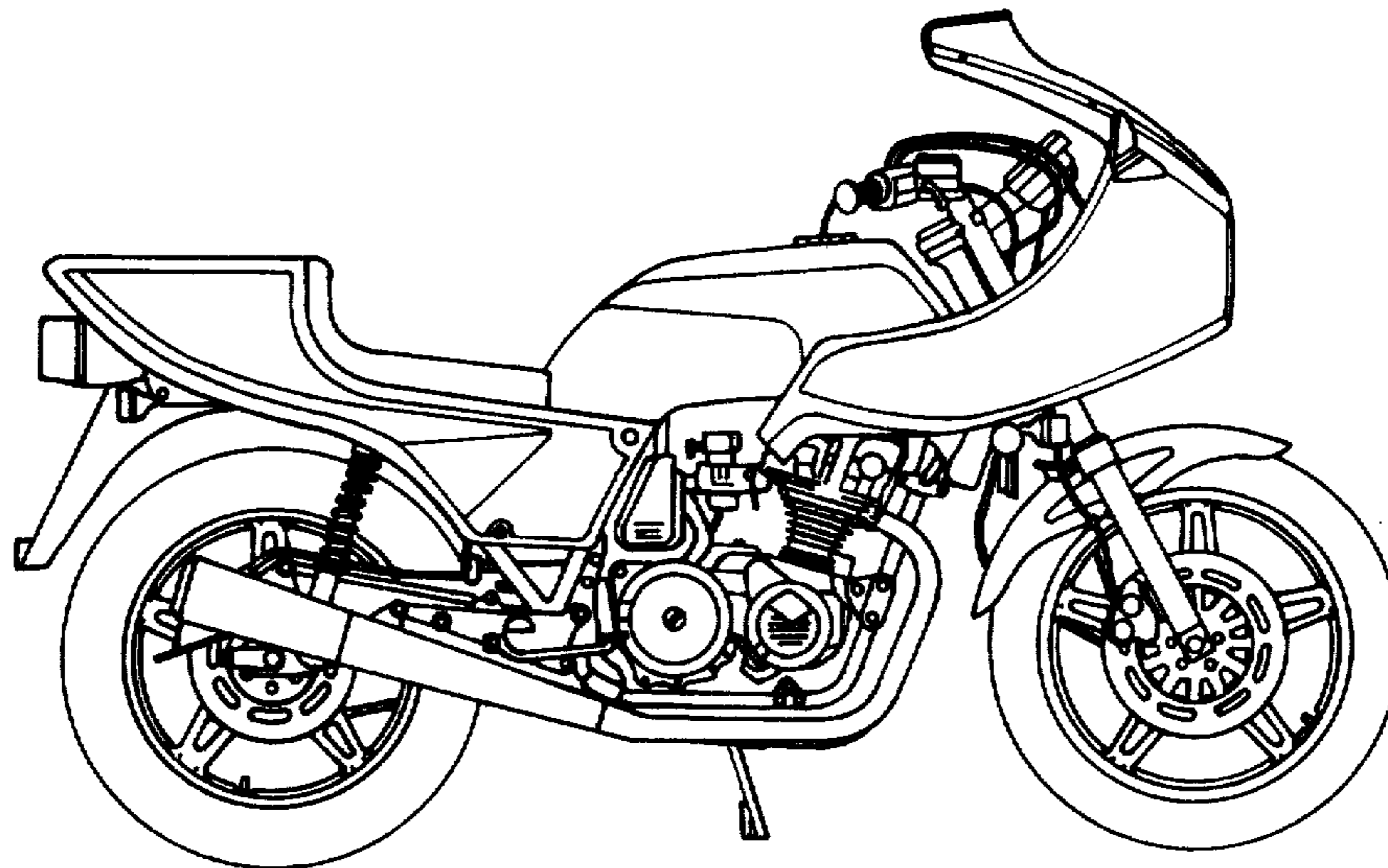

FIG. 3

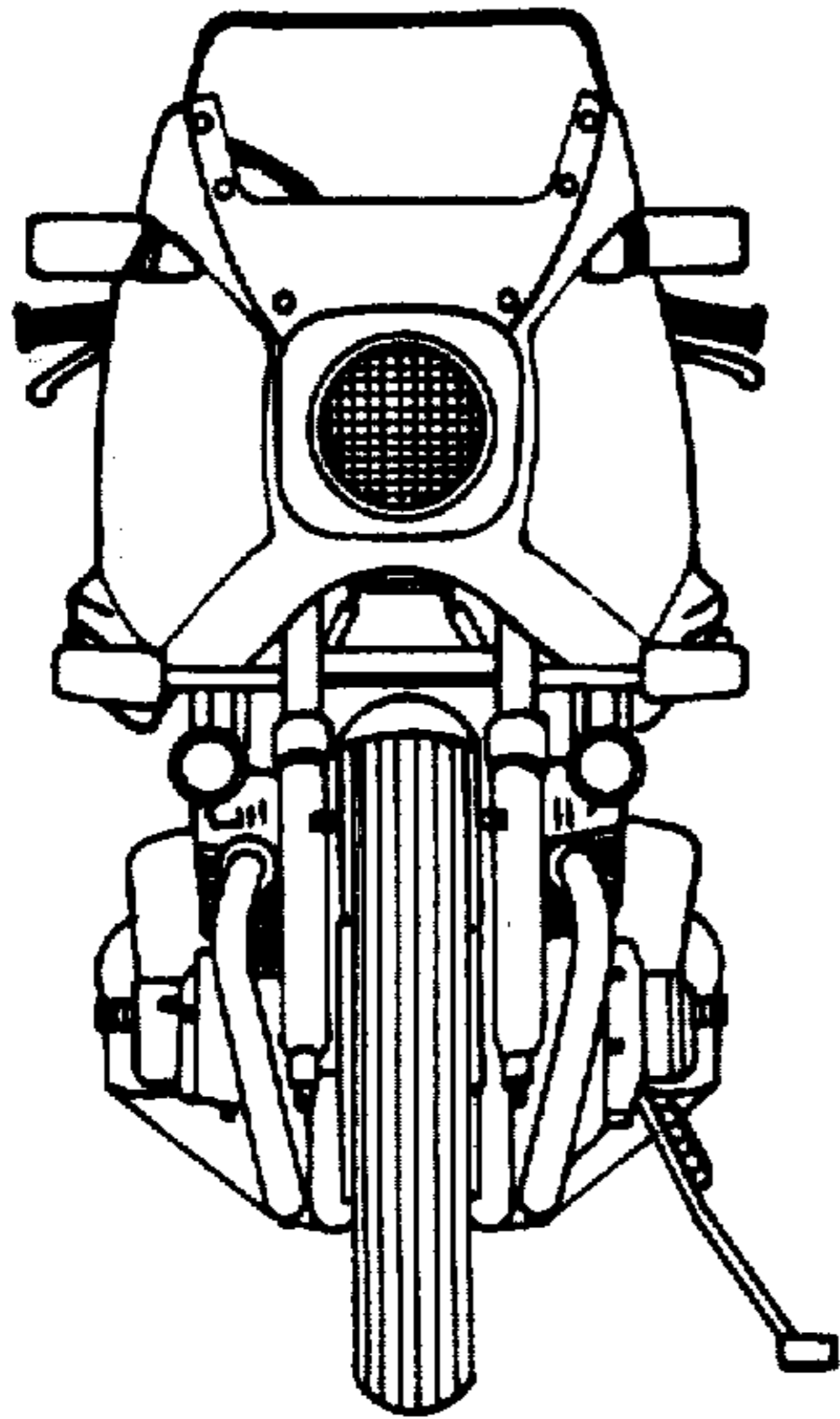

FIG. 4

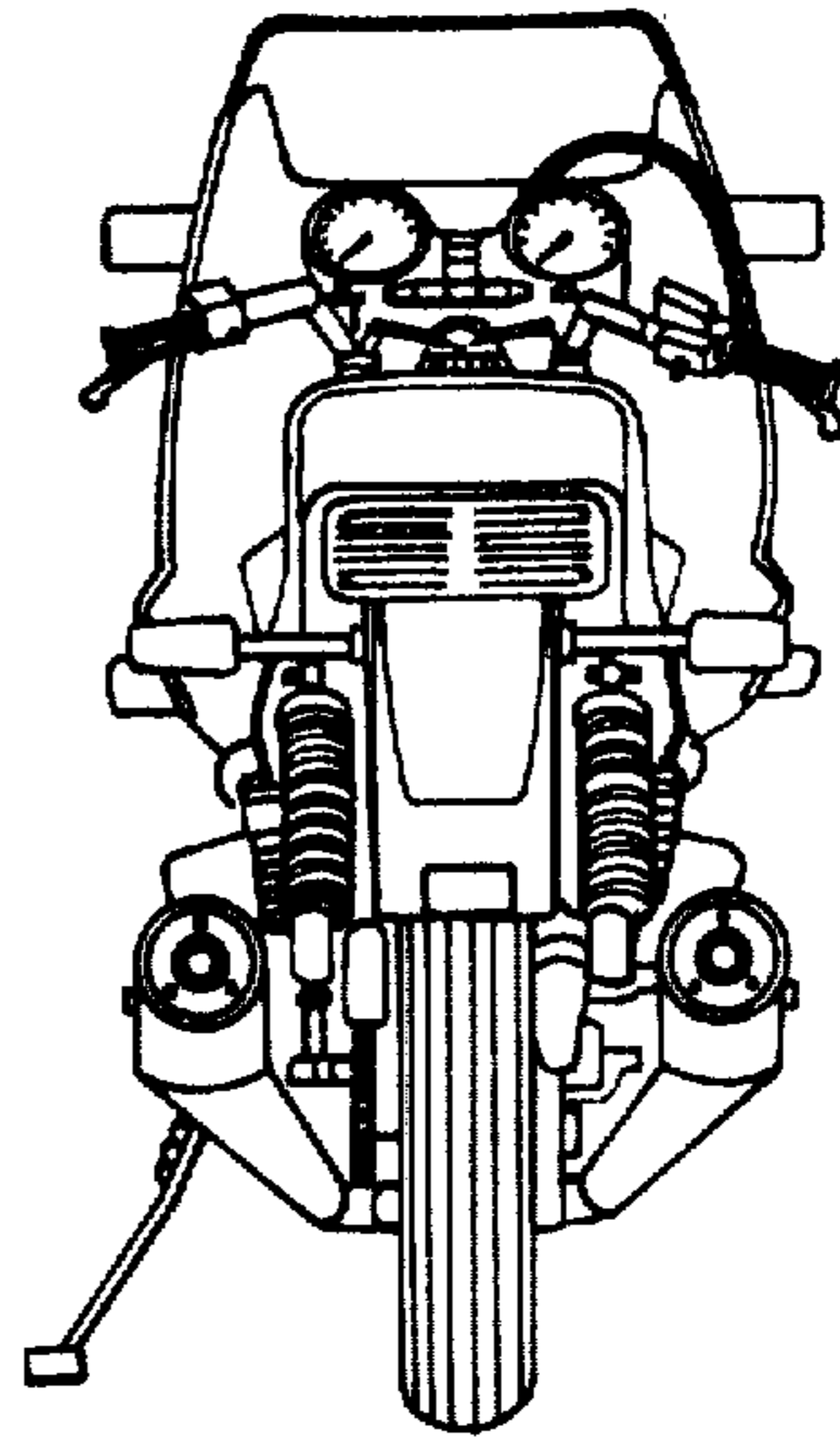

FIG. 5

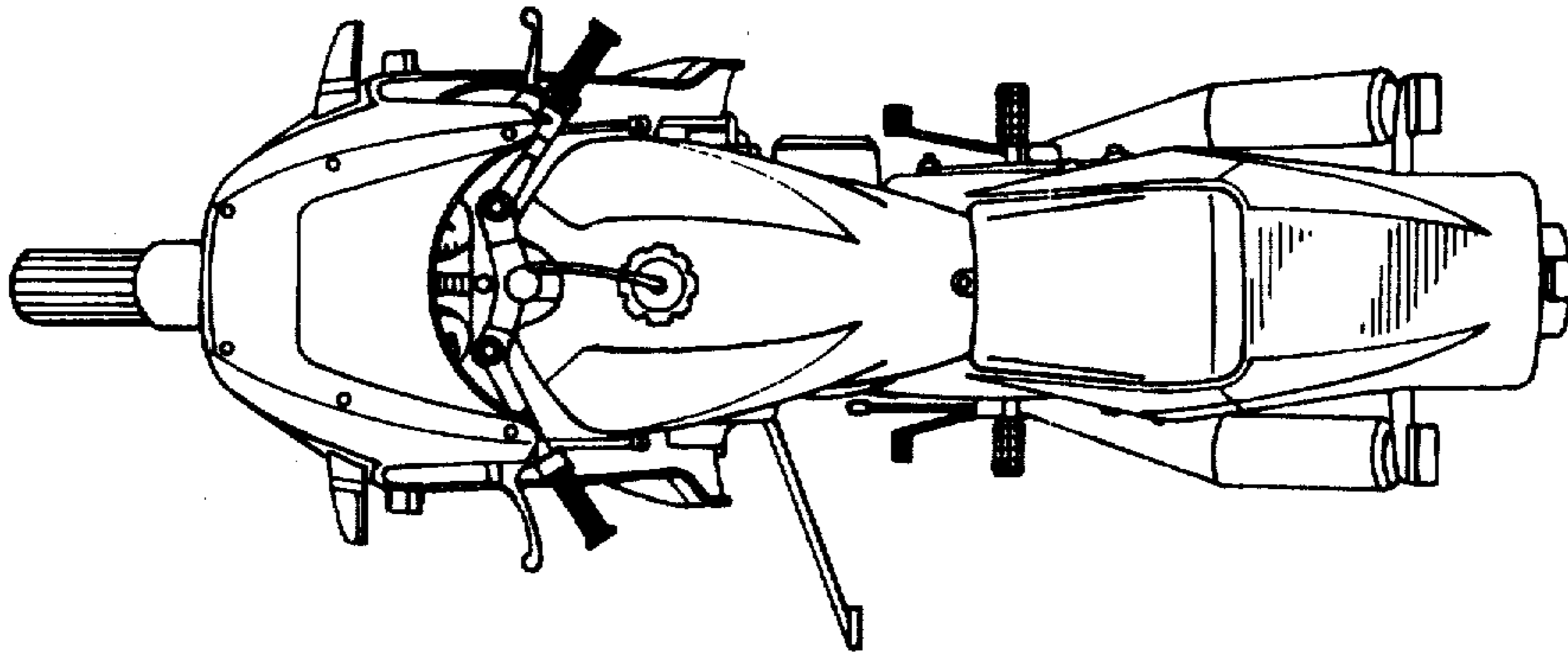

FIG. 6

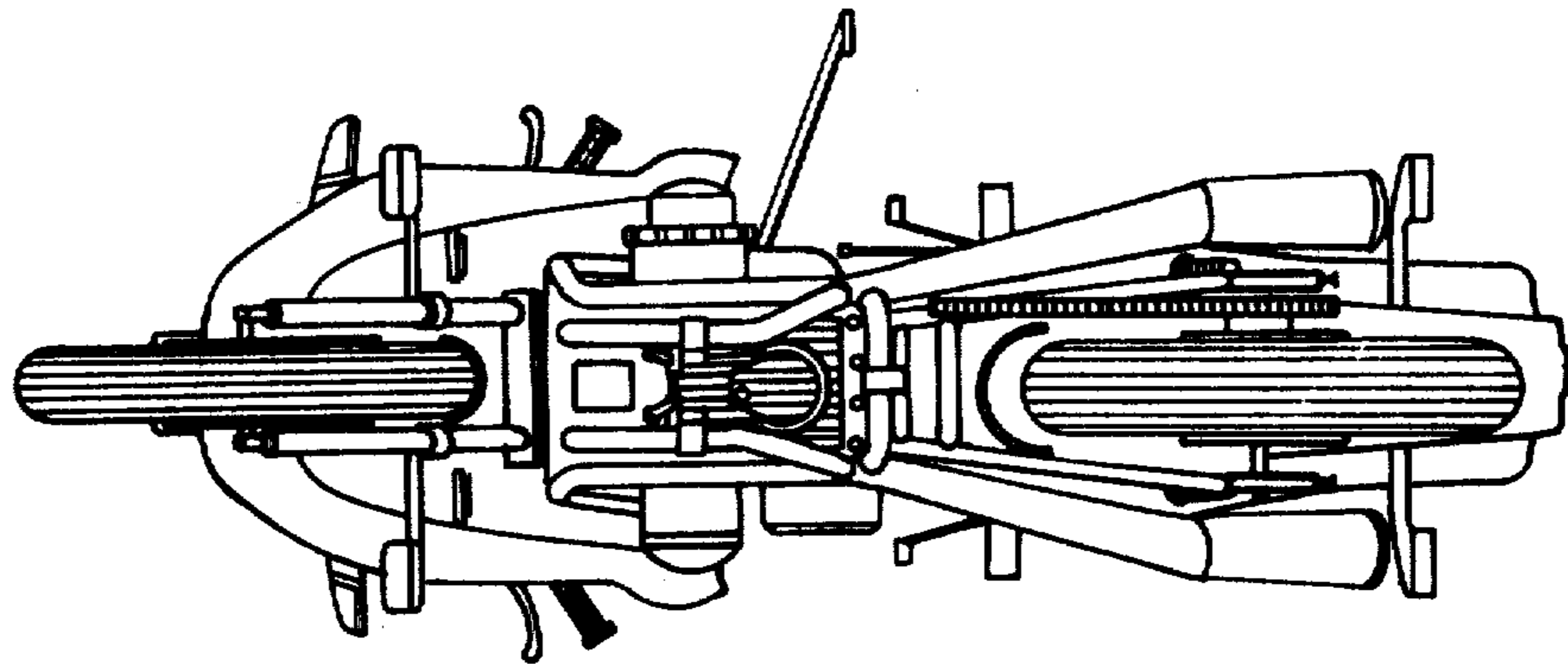

FIG. 7

