

[54] AUTOMOBILE TOOL KIT CONTAINER

[75] Inventor: Adolf Koch, Waiblingen-Neustadt, Fed. Rep. of Germany

[73] Assignee: Autohaus Lorinser GmbH & Co, Waiblingen, Fed. Rep. of Germany

[**] Term: 14 Years

[21] Appl. No.: 283,680

[22] Filed: Jul. 15, 1981

[30] Foreign Application Priority Data

Jan. 16, 1981 [DE] Fed. Rep. of Germany 844

[51] Int. Cl. D3-02

[52] U.S. Cl. D3/40; D3/30.1

[58] Field of Search D3/30.1, 33, 35, 66, D3/78, 76; 224/35, 32 R; D12/155; 206/372, 373, 349, 379

[56] References Cited

U.S. PATENT DOCUMENTS

D. 195,895 8/1963 Ehle D3/66
D. 253,438 11/1979 Markley D3/76
3,578,153 5/1971 Olson 206/379

FOREIGN PATENT DOCUMENTS

14597 of 1910 United Kingdom 224/35

Primary Examiner—George P. Word
Attorney, Agent, or Firm—Michael J. Striker

[57] CLAIM

The ornamental design for an automobile tool kit container, substantially as shown and described.

DESCRIPTION

FIG. 1 is a front elevational view of an automobile tool kit container embodying my new design.
FIG. 2 is a side elevational view taken on a plane parallel to the long side of the automobile tool kit container.
FIG. 3 is a top plan view thereof;
FIG. 4 is a left end elevational view thereof; and
FIG. 5 is a rear elevational view thereof.

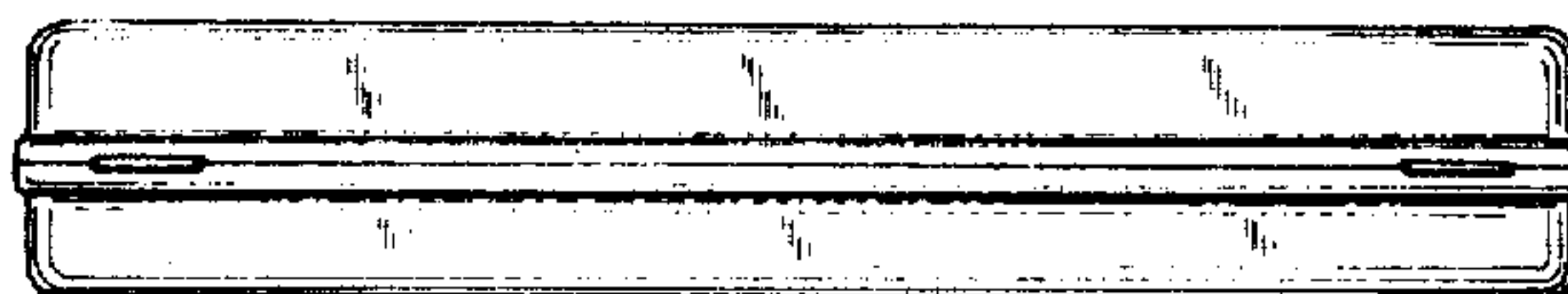
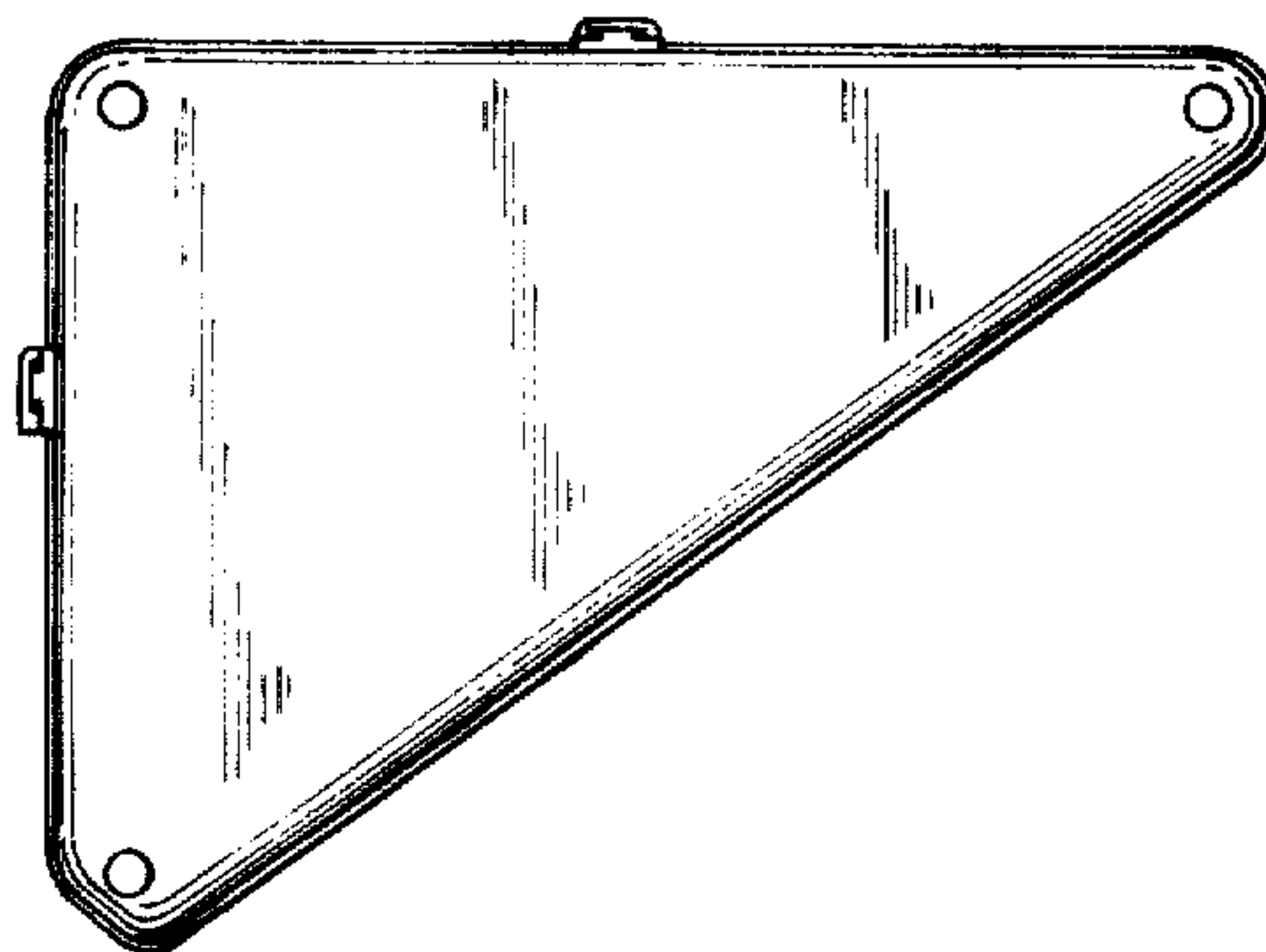

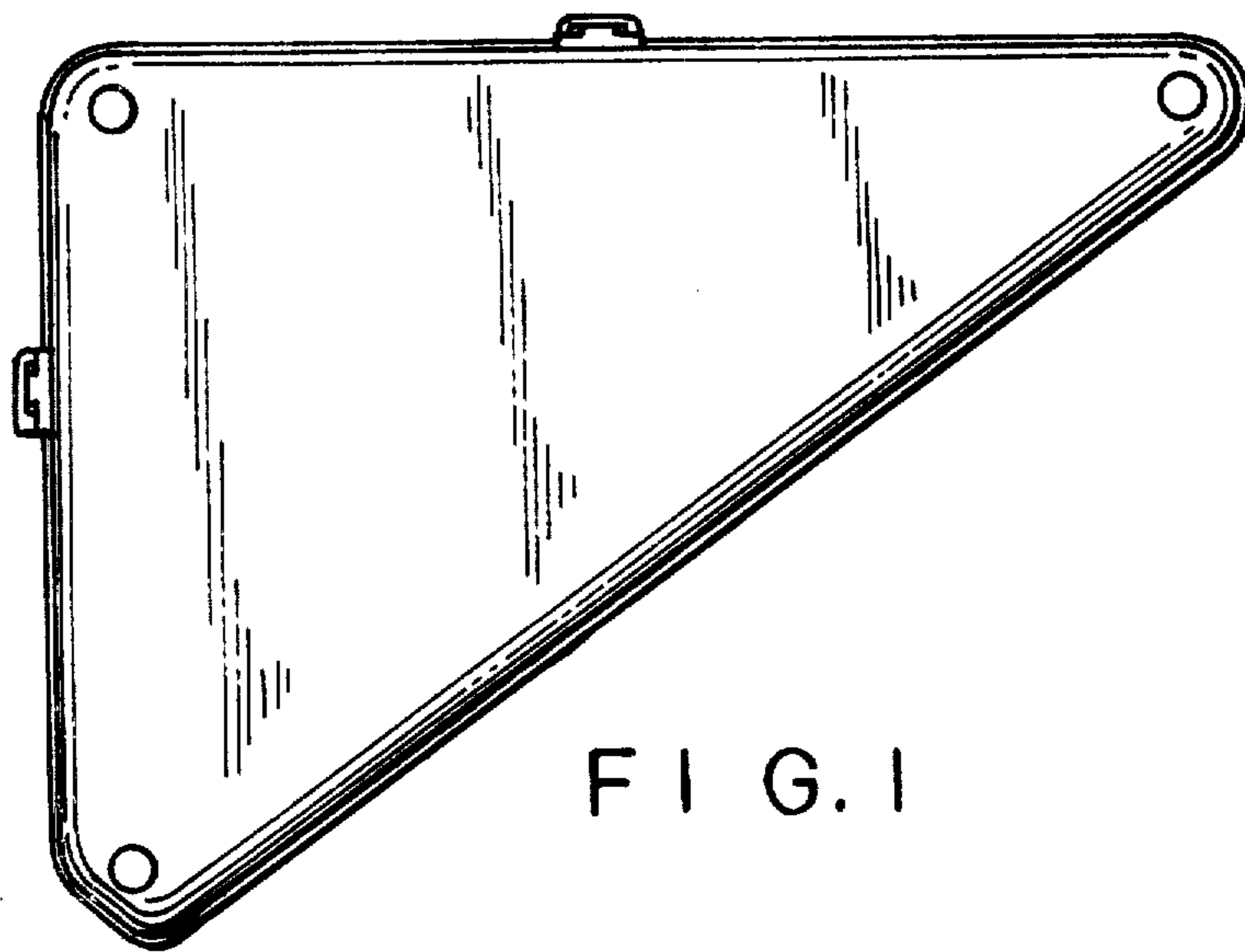

FIG. 1

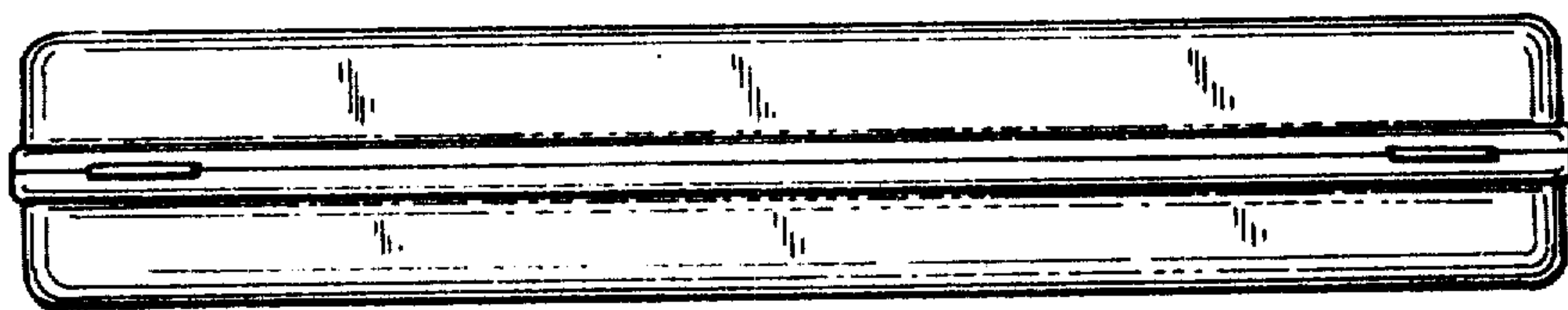

FIG. 2

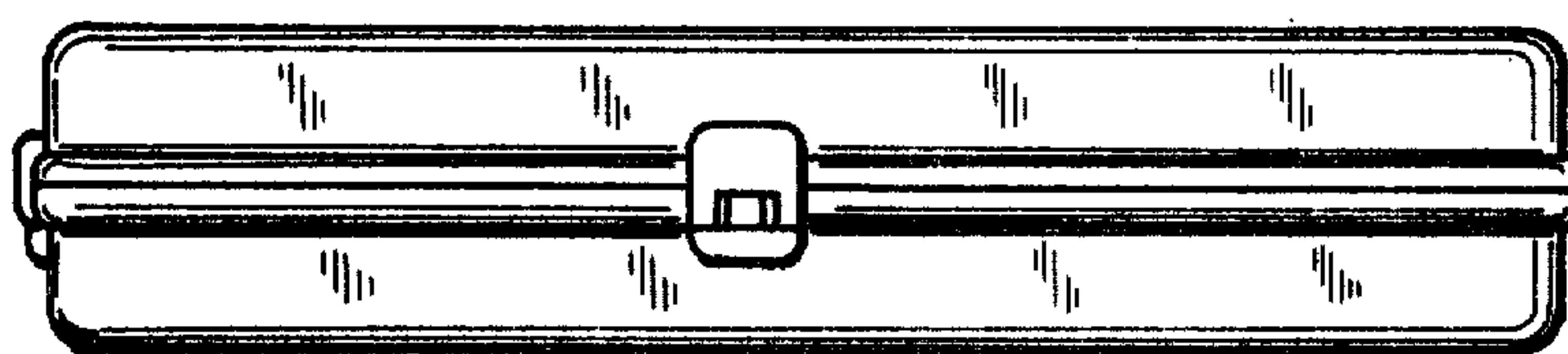

FIG. 3

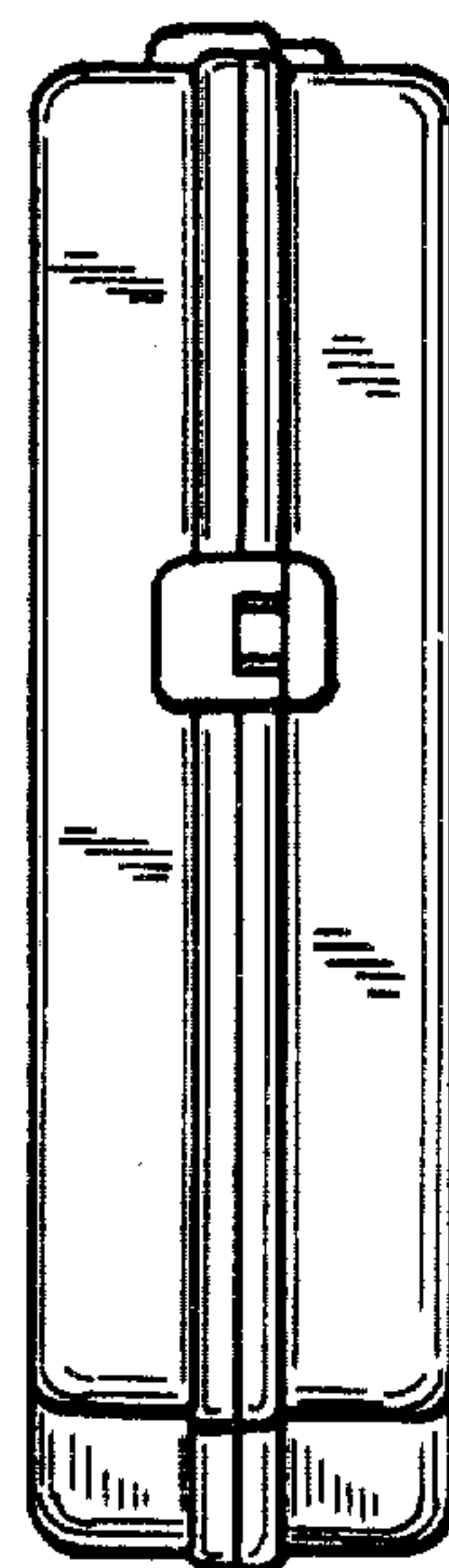

FIG. 4

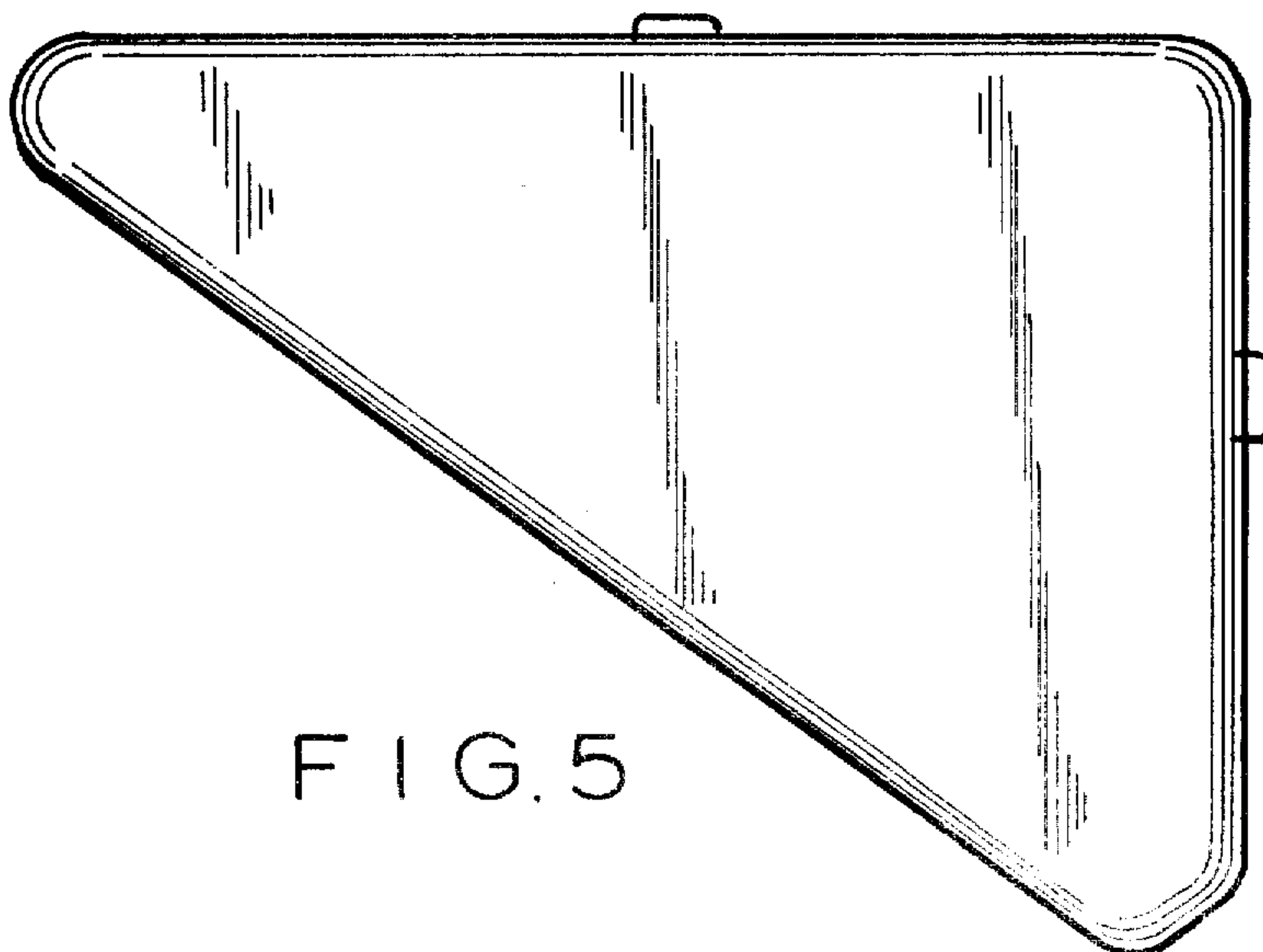

FIG. 5