

- [54] **CAMERA**
- [75] **Inventors: Nobuhiro Agou; Mutsuhide Matsuda,**
both of Yokohama, Japan
- [73] **Assignee: Canon Kabushiki Kaisha, Tokyo,**
Japan
- [**] **Term: 14 Years**
- [21] **Appl. No.: 480,335**
- [22] **Filed: Mar. 30, 1983**
- [51] **Int. Cl. D16-01**
- [52] **U.S. Cl. D16/1**
- [58] **Field of Search D16/1, 2, 6-10;**
354/126-128, 152-156, 162-169, 202, 288, 145

- D. 247,852 5/1978 Fukuda D16/6
- D. 257,983 1/1981 Maitani D16/6
- D. 262,633 1/1982 Kato D16/6
- D. 263,056 2/1982 Hattori D16/5
- D. 264,343 5/1982 Che D16/7
- D. 266,331 9/1982 Schultes D16/6
- 4,299,465 11/1981 Chan 354/145

OTHER PUBLICATIONS

Chinon-Flyer—"People Who Love People Love Chinon"—p. 3-7/79—Camera at bottom-left.
Photography-6/82-p. 66—Canon A1-1 Camera.

Primary Examiner—Nelson C. Holtje
Attorney, Agent, or Firm—Fitzpatrick, Cella, Harper & Scinto

[56] **References Cited**
U.S. PATENT DOCUMENTS

- D. 185,350 6/1959 Crapsey D16/1 X
- D. 195,286 5/1963 Olson D16/6
- D. 210,050 1/1968 Quinn D16/1
- D. 213,806 4/1969 Ikegami D16/1
- D. 213,852 4/1969 Olson D16/6
- D. 222,653 11/1971 Emmerling D16/1
- D. 223,409 4/1972 Fukuda D16/6
- D. 224,572 8/1972 Emmerling D16/6
- D. 229,977 1/1974 Nakanishi D16/1
- D. 238,613 1/1976 Waaske D16/1

[57] **CLAIM**

The ornamental design for a camera, as shown and described.

DESCRIPTION

FIG. 1 is a front elevational view of a camera showing our new design;
FIG. 2 is a rear elevational view thereof;
FIG. 3 is a top plan view thereof;
FIG. 4 is a bottom plan view thereof;
FIG. 5 is a left side elevational view thereof;
FIG. 6 is a right side elevational view thereof;
FIG. 7 is a top and left front perspective view thereof.

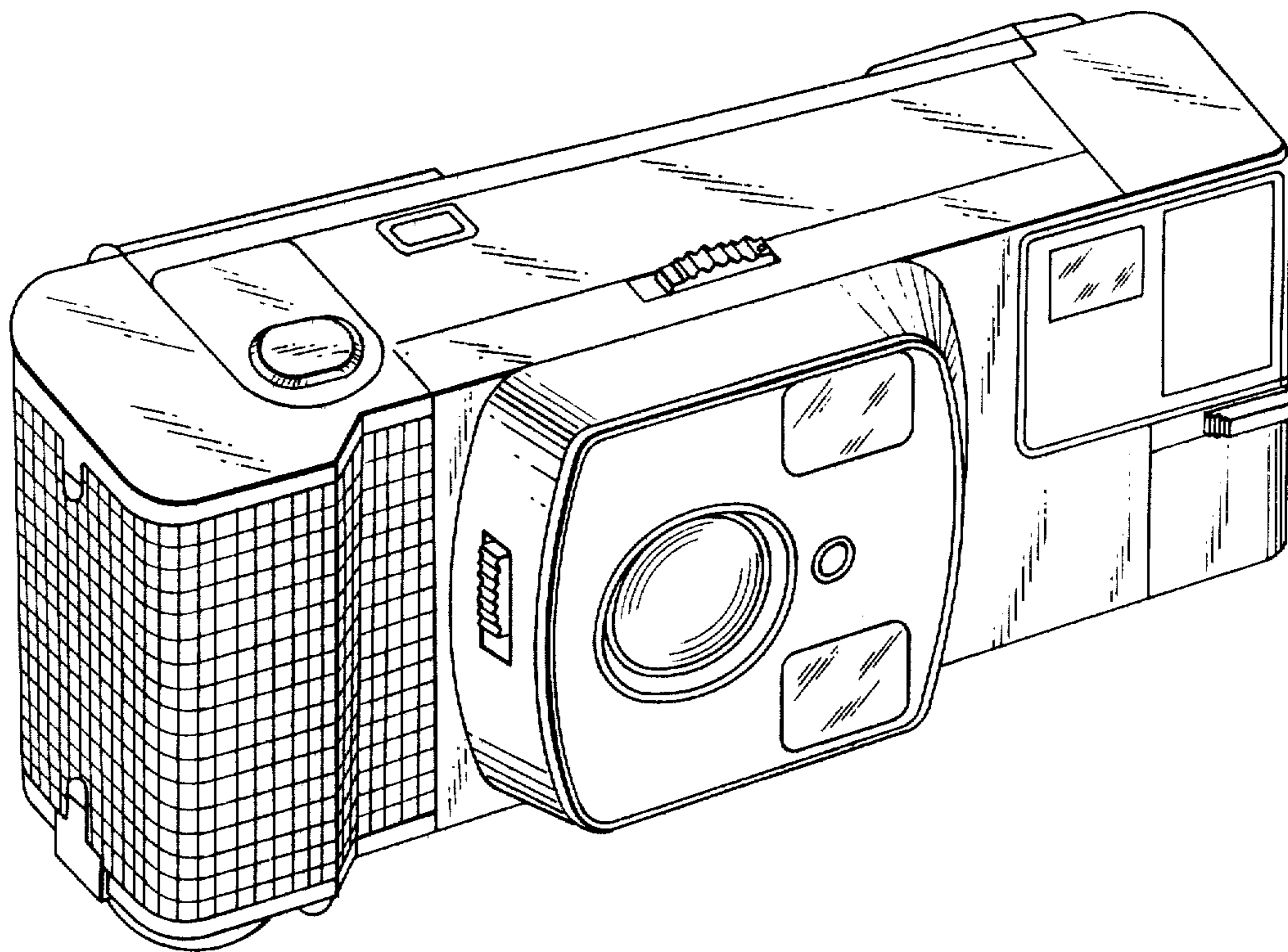

FIG. 1

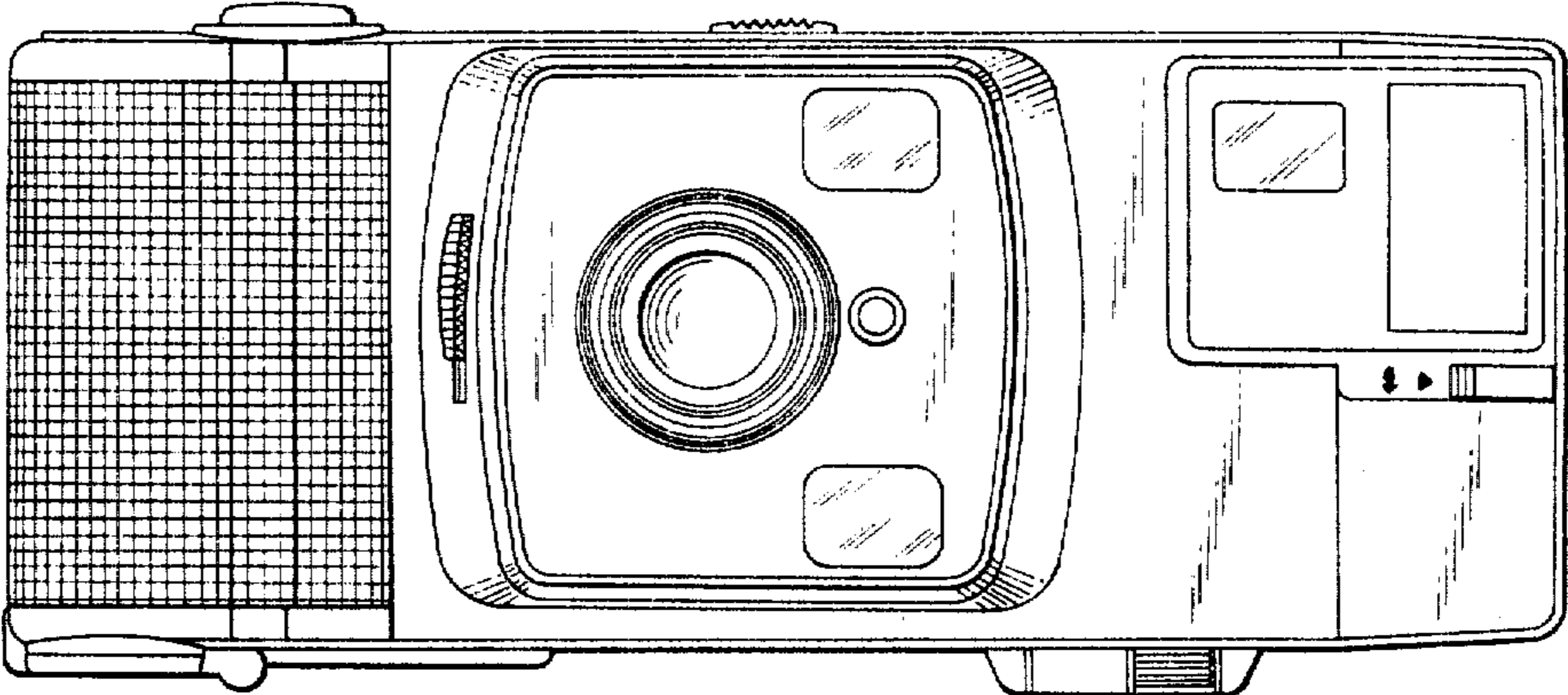

FIG. 2

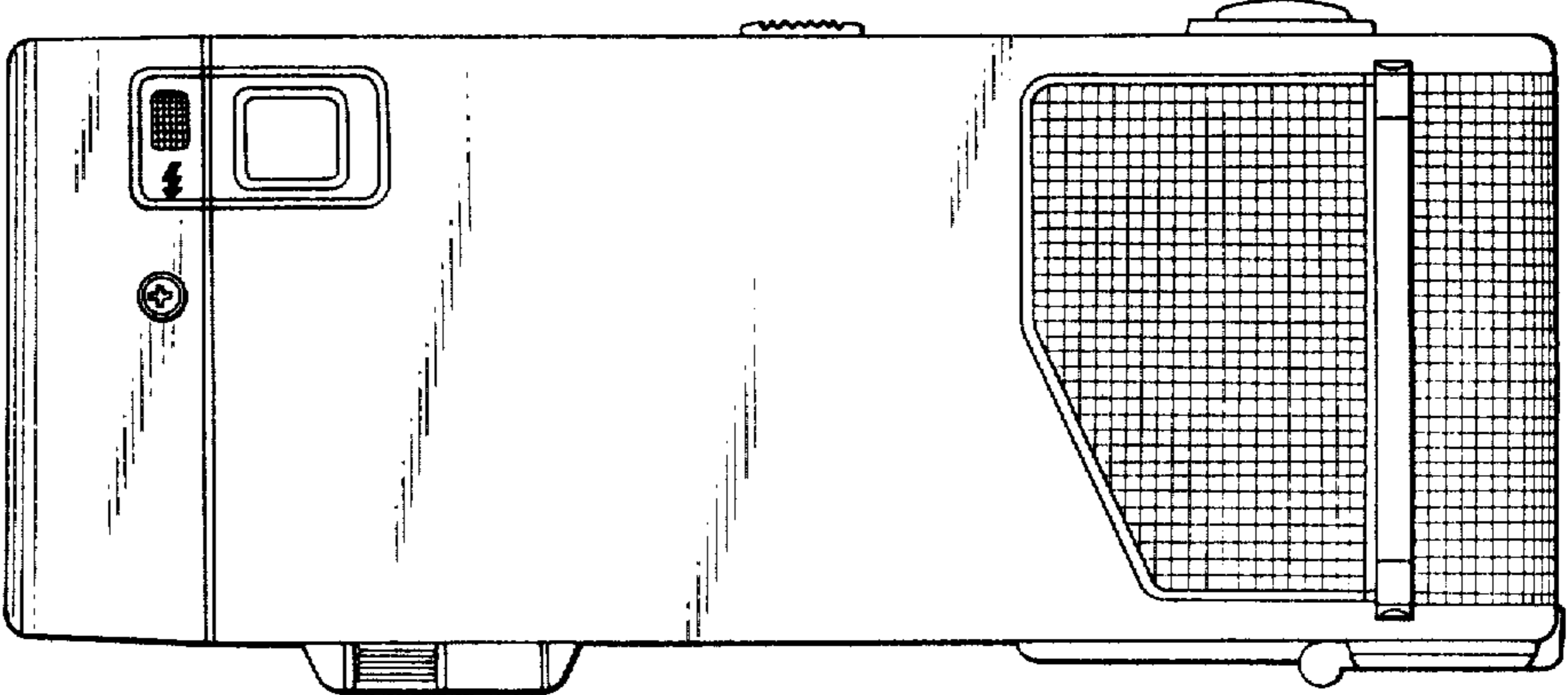

FIG. 3

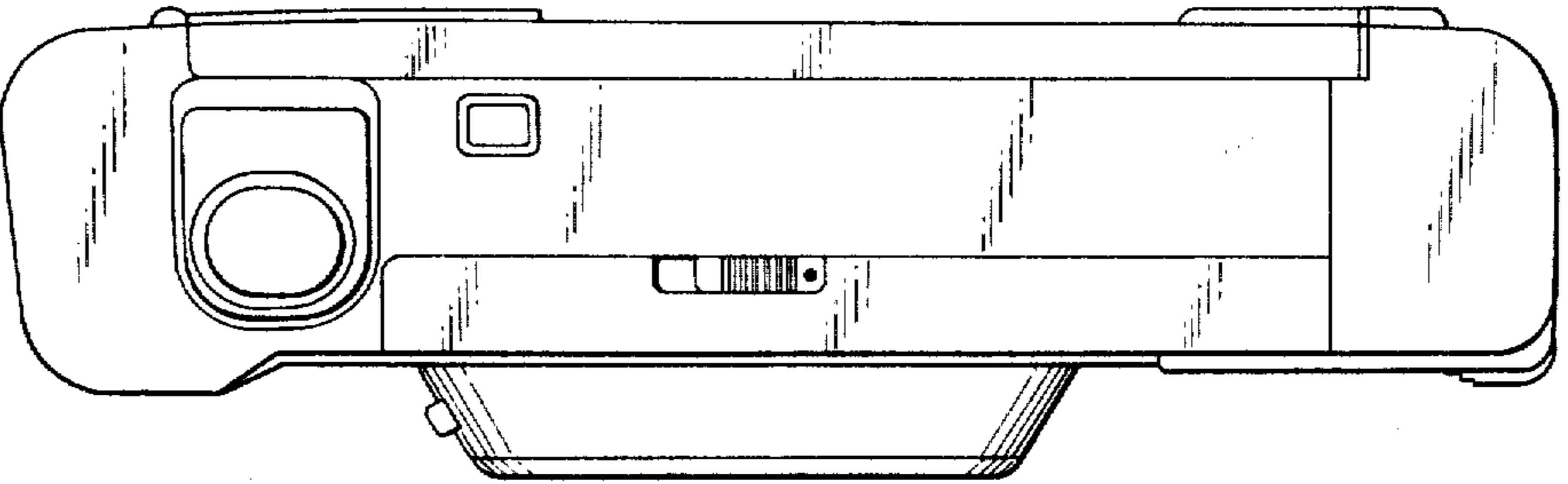

FIG. 4

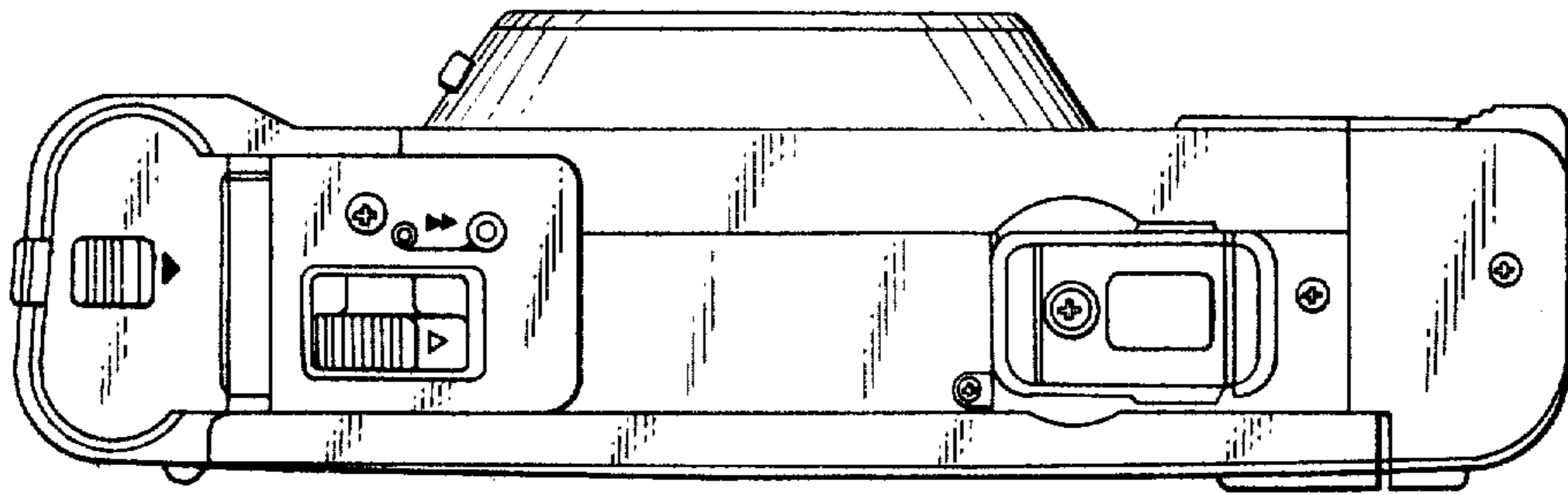

FIG. 5

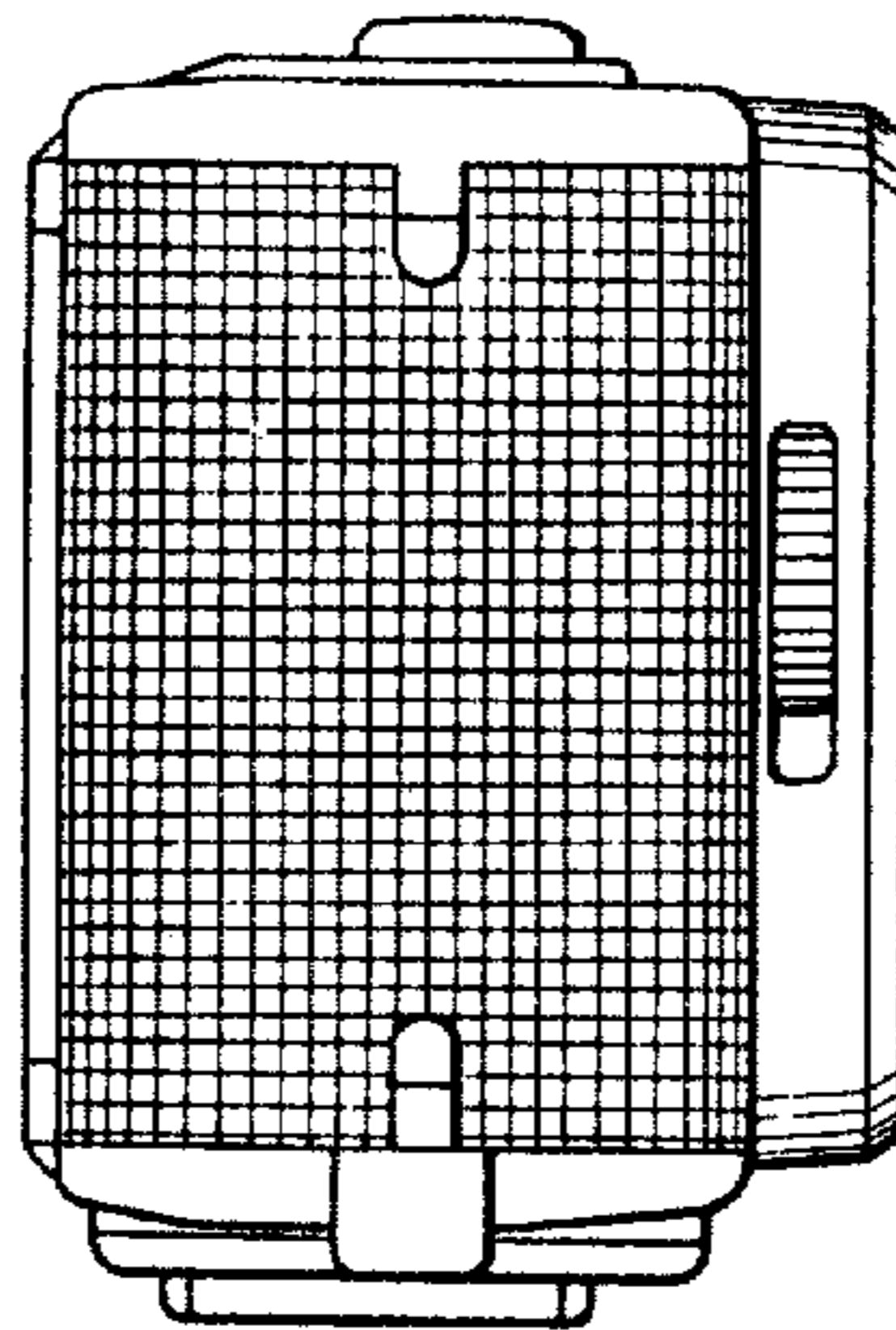

FIG. 6

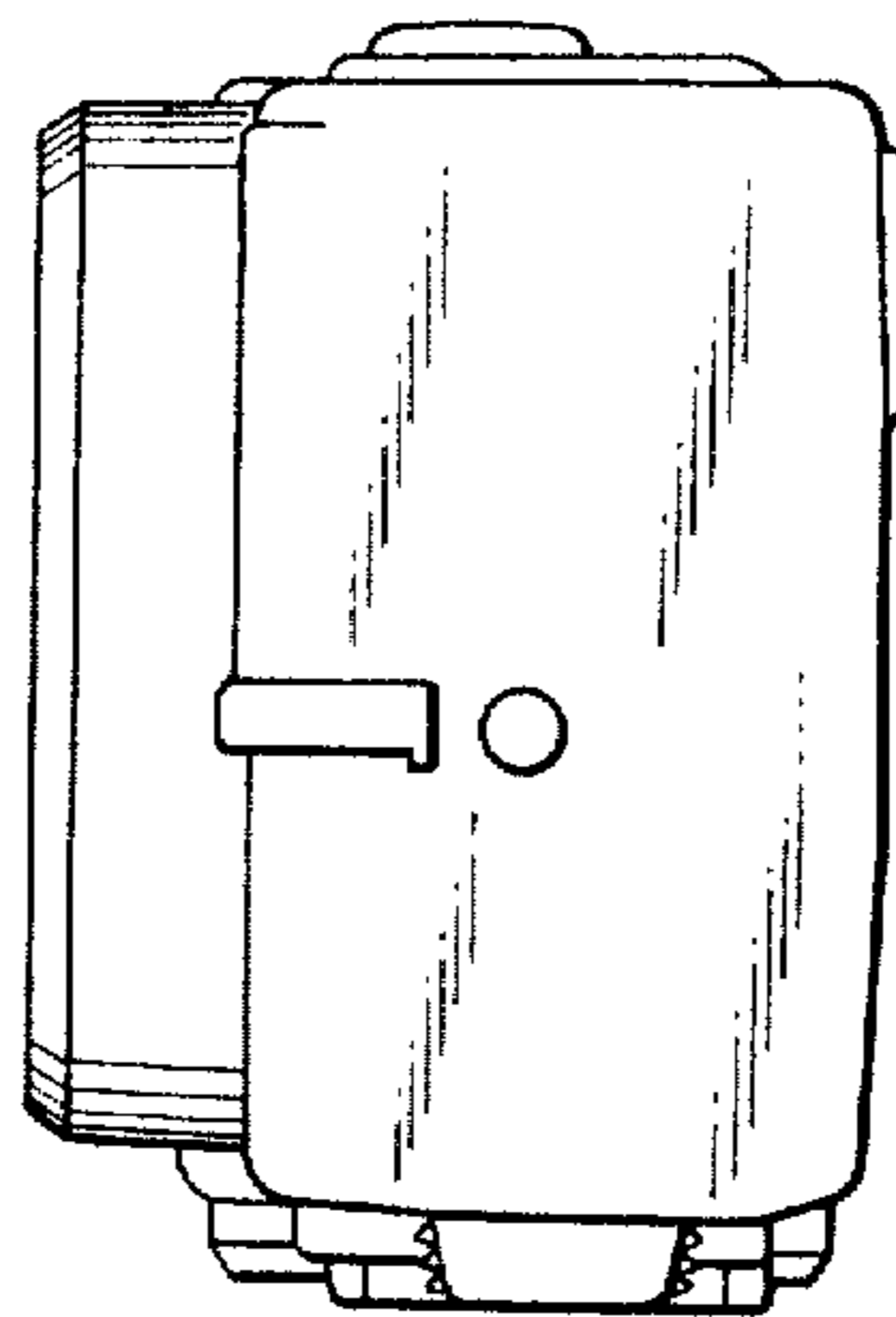

FIG. 7

