

[54] HELIODON-TYPE DEVICE

[76] Inventor: Jon Massaro, 2152 Stoneyvale Ave., Tujunga, Calif. 91042

[\*\*] Term: 14 Years

[21] Appl. No.: 159,942

[22] Filed: Jun. 16, 1980

Related U.S. Application Data

[63] Continuation-in-part of Ser. No. 946,805, Sep. 28, 1978, abandoned.

[51] Int. Cl. D6-03
[52] U.S. Cl. D6/27; D6/29
[58] Field of Search 33/1 DD; D10/46; D6/156, 27, 29, 178; 108/1, 4, 5, 6; 248/371, 393, 397, 398

[56] References Cited

U.S. PATENT DOCUMENTS

D. 236,045 7/1975 Petrie D6/27
3,090,124 5/1963 Frühling 33/1 DD X
3,568,320 3/1971 Potter 33/1 DD
4,077,333 3/1978 Ballas D6/27 X

FOREIGN PATENT DOCUMENTS

367123 2/1932 United Kingdom 33/1 DD

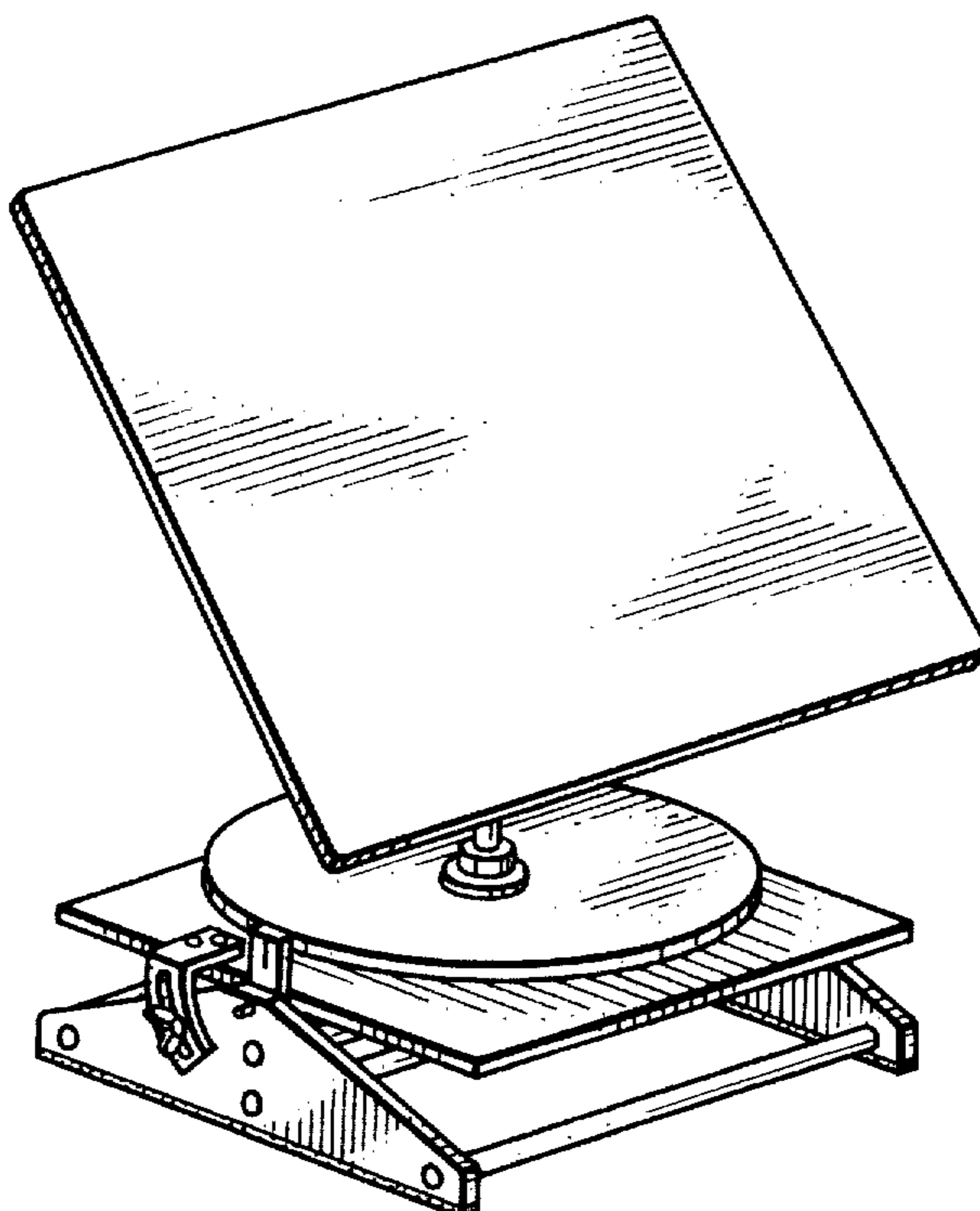
Primary Examiner—Susan J. Lucas
Attorney, Agent, or Firm—Cislo, O'Reilly & Thomas

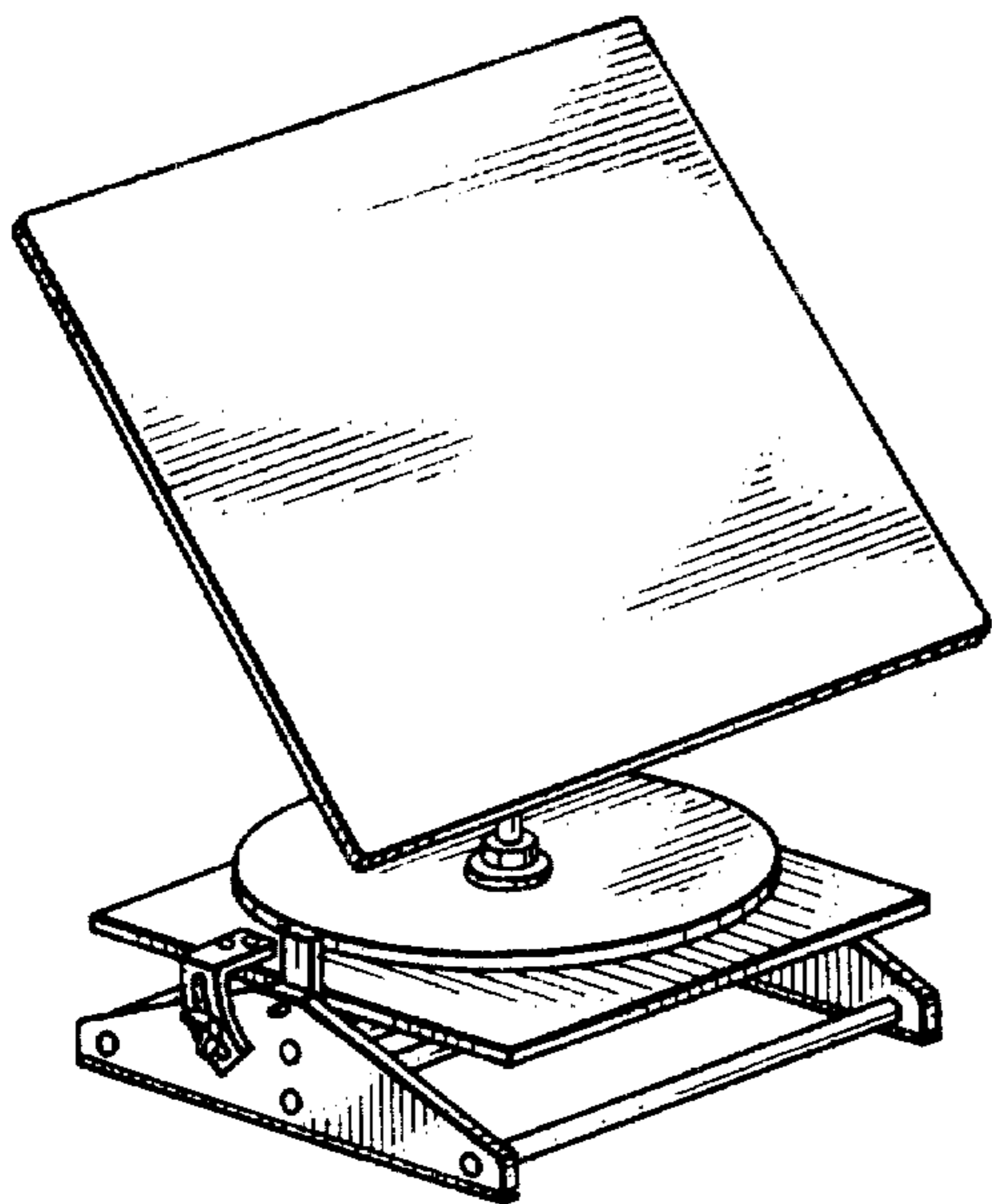
[57] CLAIM

The ornamental design for a heliodon-type device, as shown and described.

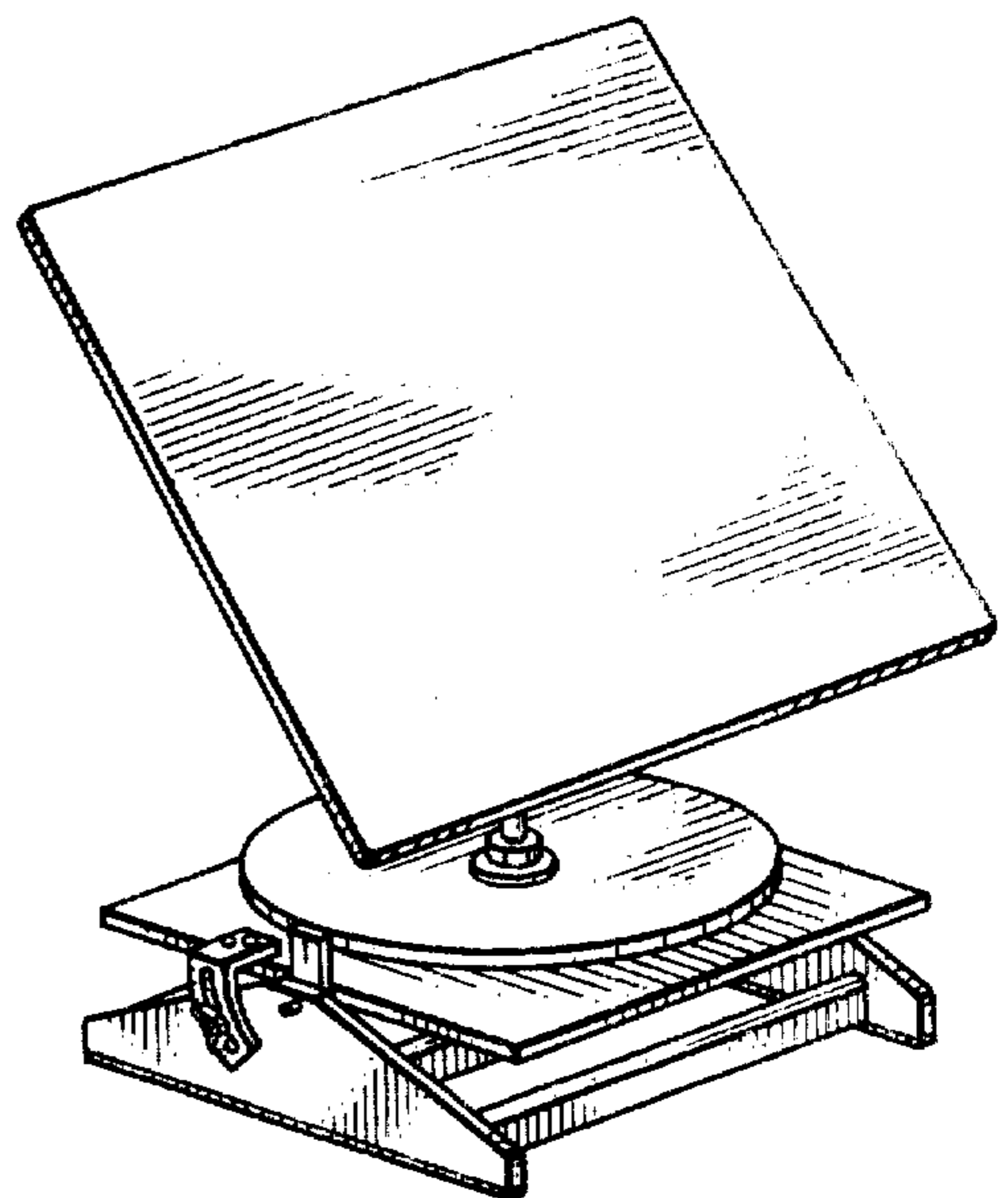
DESCRIPTION

FIG. 1 is a perspective view of my heliodon-type device showing my new design; FIG. 2 is a front view of the device illustrated in FIG. 1 on an enlarged scale; FIG. 3 is a right side view of the device illustrated in FIG. 1 on an enlarged scale; FIG. 4 is a rear view of the device illustrated in FIG. 1 on an enlarged scale; FIG. 5 is a left side view of the device illustrated in FIG. 1 on an enlarged scale; FIG. 6 is a top view of the device illustrated in FIG. 1 on an enlarged scale; FIG. 7 is a bottom view of the device illustrated in FIG. 1 on an enlarged scale; FIG. 8 is a perspective view of an alternative embodiment of my device; FIG. 9 is a perspective view of still another alternative embodiment of my device; FIG. 10 is a front view of the device illustrated in FIG. 9 on an enlarged scale; FIG. 11 is a right side view of the device illustrated in FIG. 9 on an enlarged scale; FIG. 12 is a rear view of the device illustrated in FIG. 9 on an enlarged scale; FIG. 13 is a left side view of the device illustrated in FIG. 9 on an enlarged scale; FIG. 14 is a top view of the device illustrated in FIG. 9 on an enlarged scale; and FIG. 15 is a bottom view of the device illustrated in FIG. 14 on an enlarged scale.

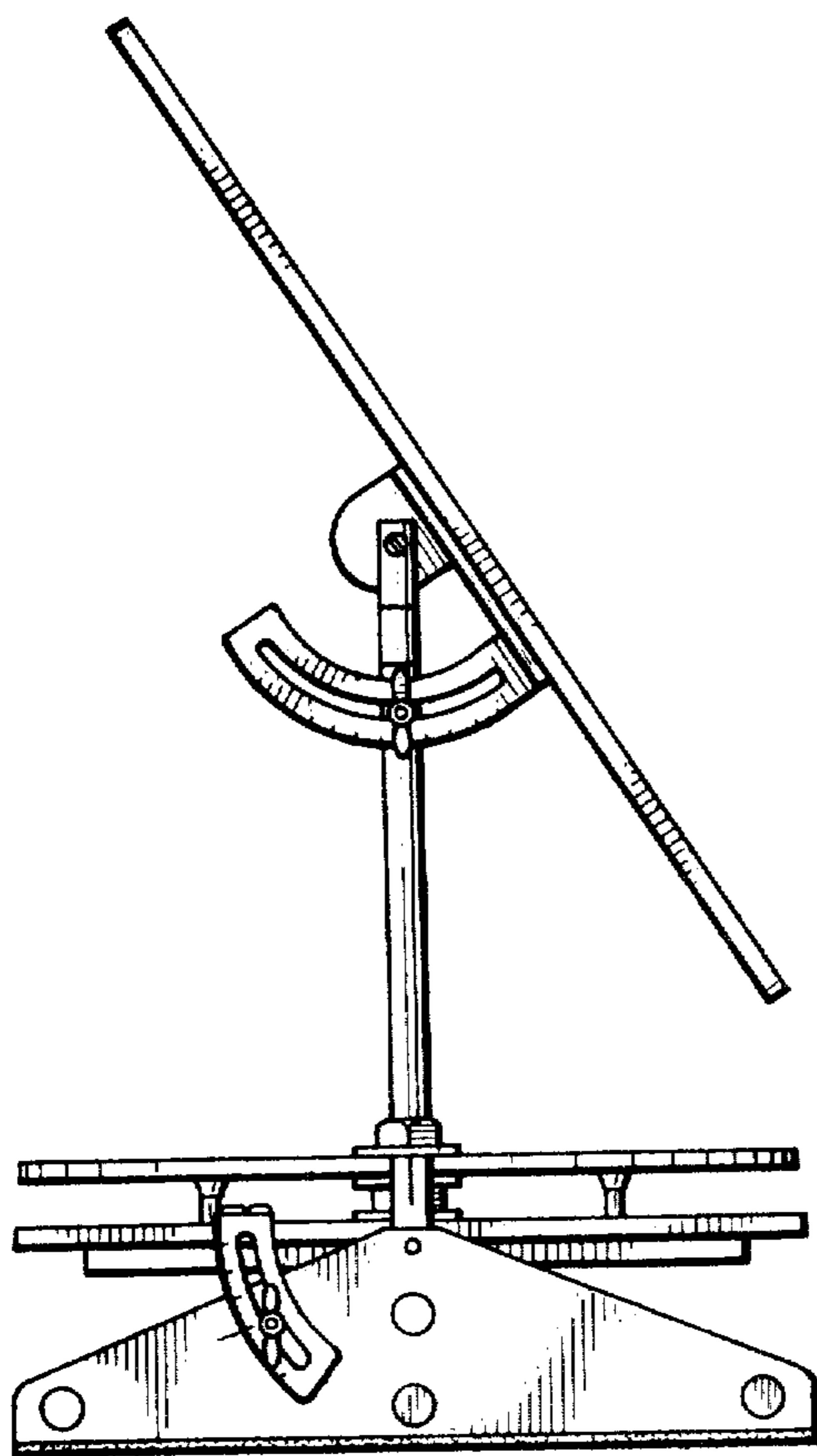




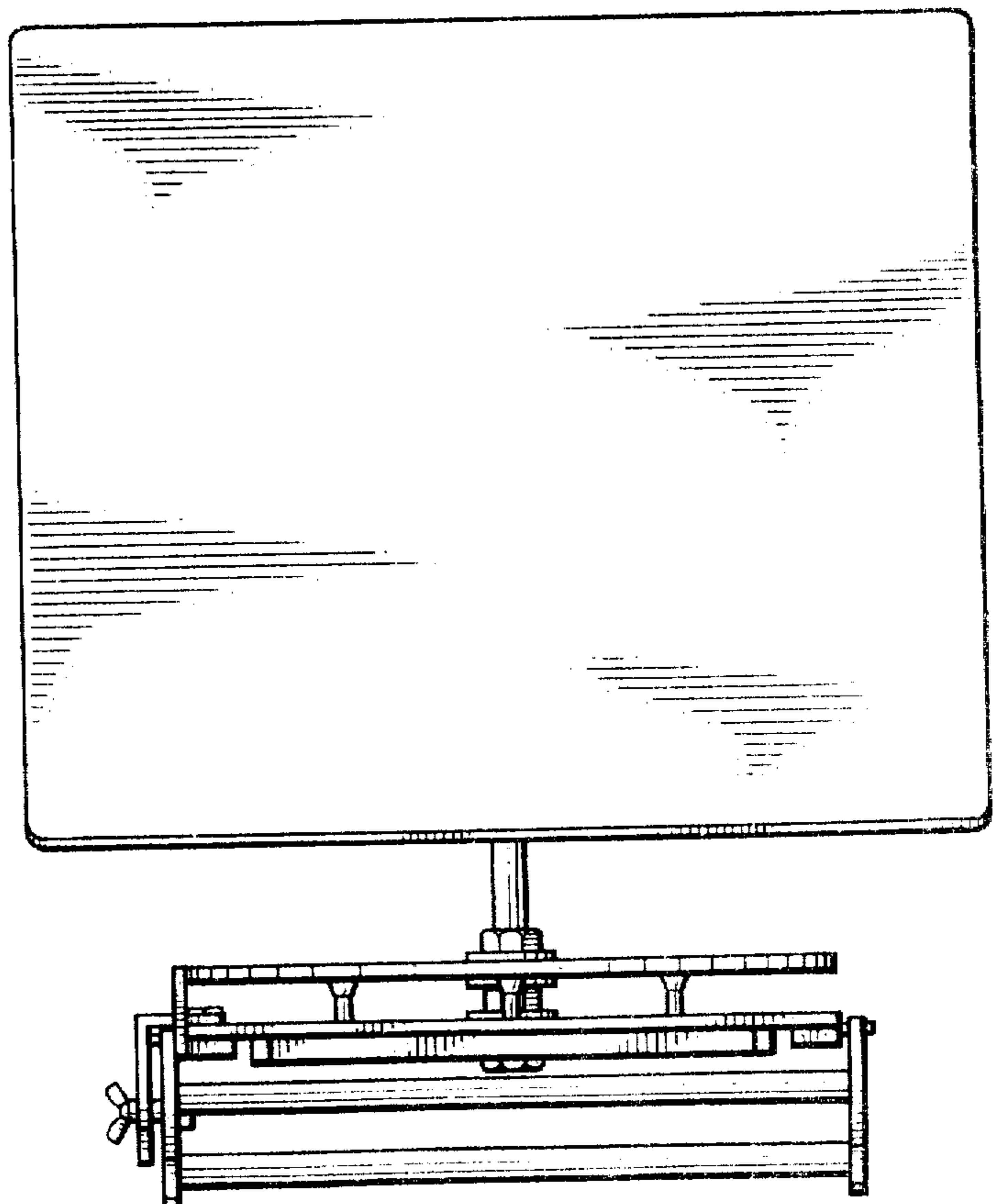
*Fig. 1.*



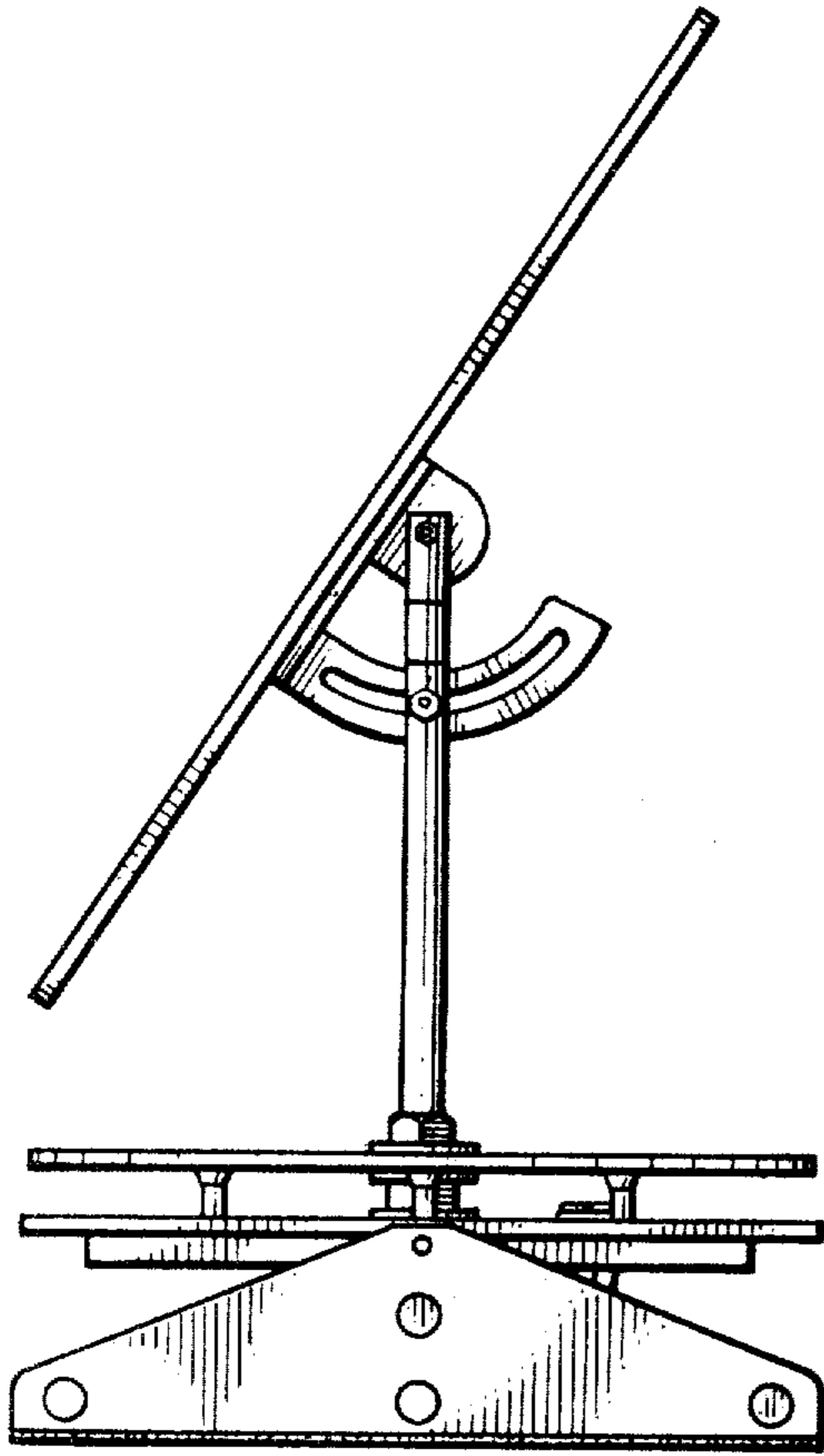
*Fig. 8.*



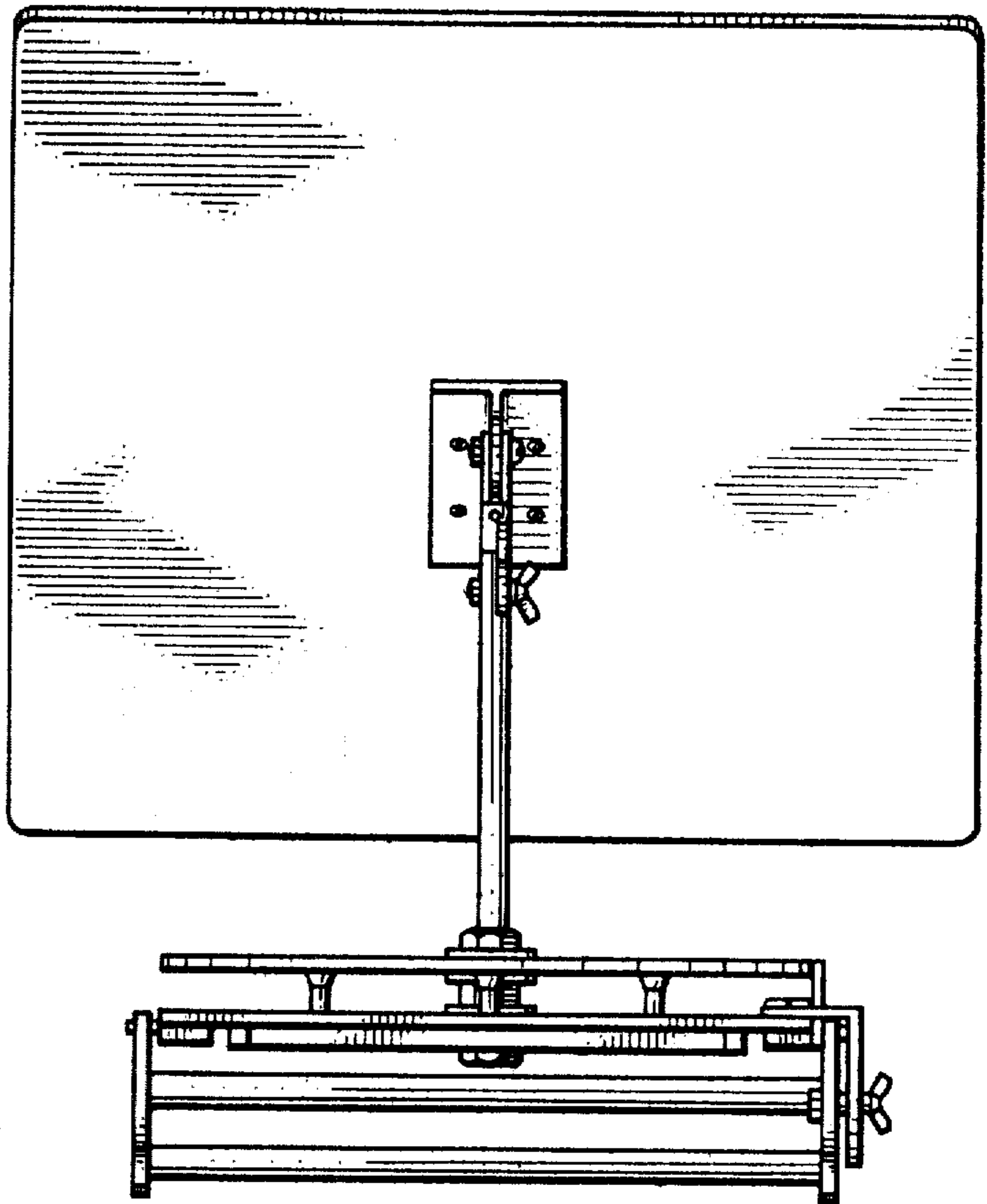
*Fig. 2.*



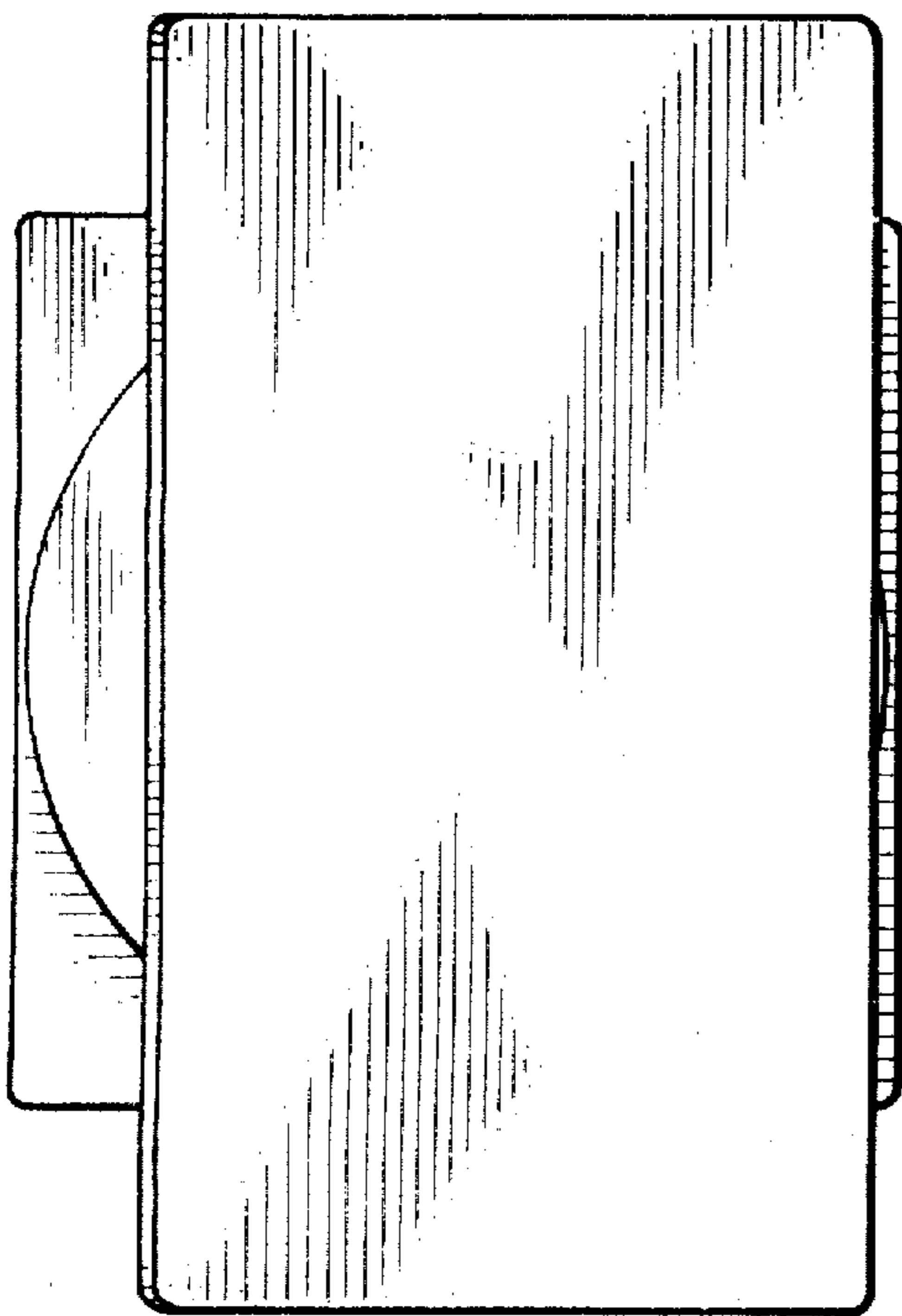
*Fig. 3.*



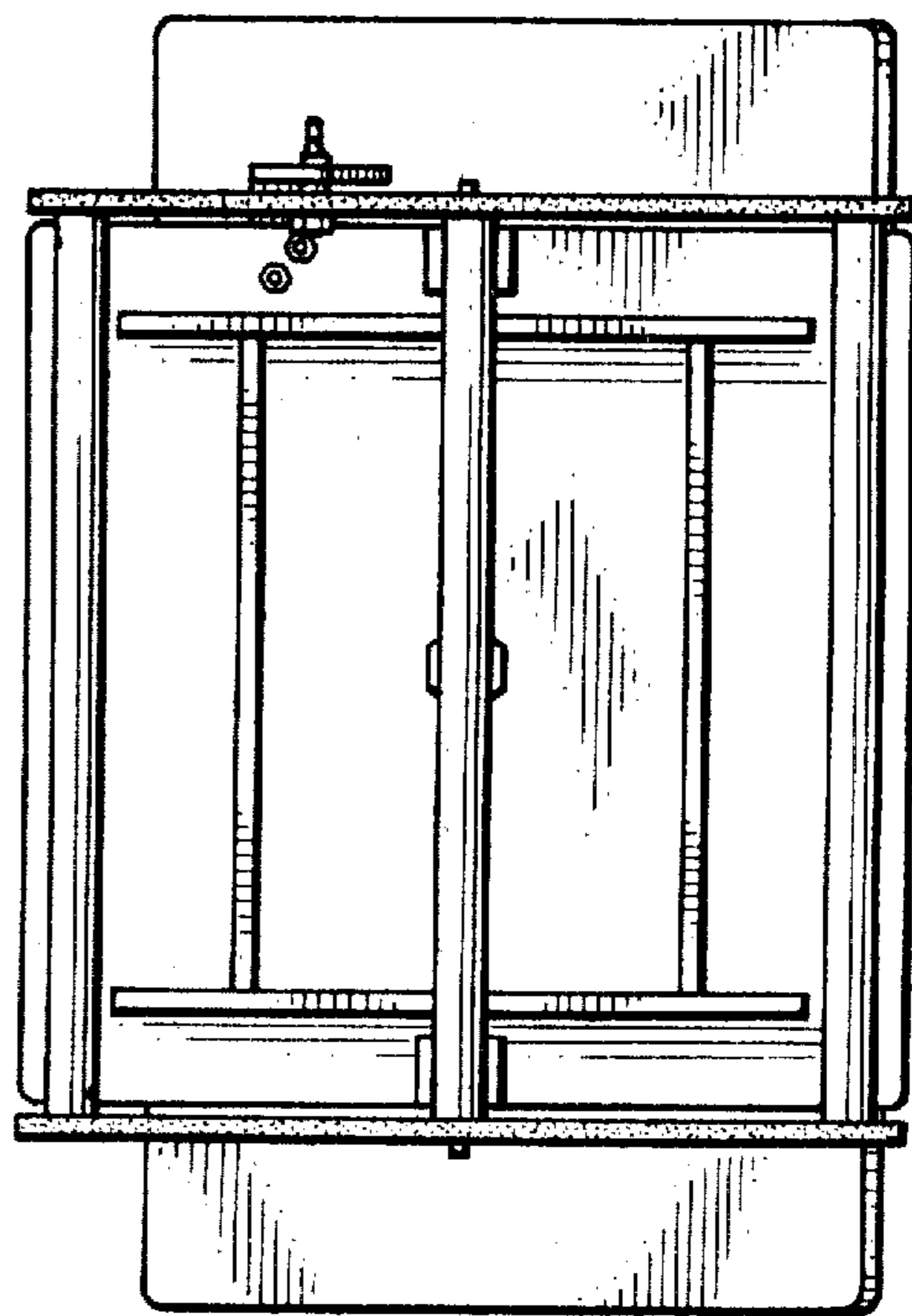
*Fig. 4.*



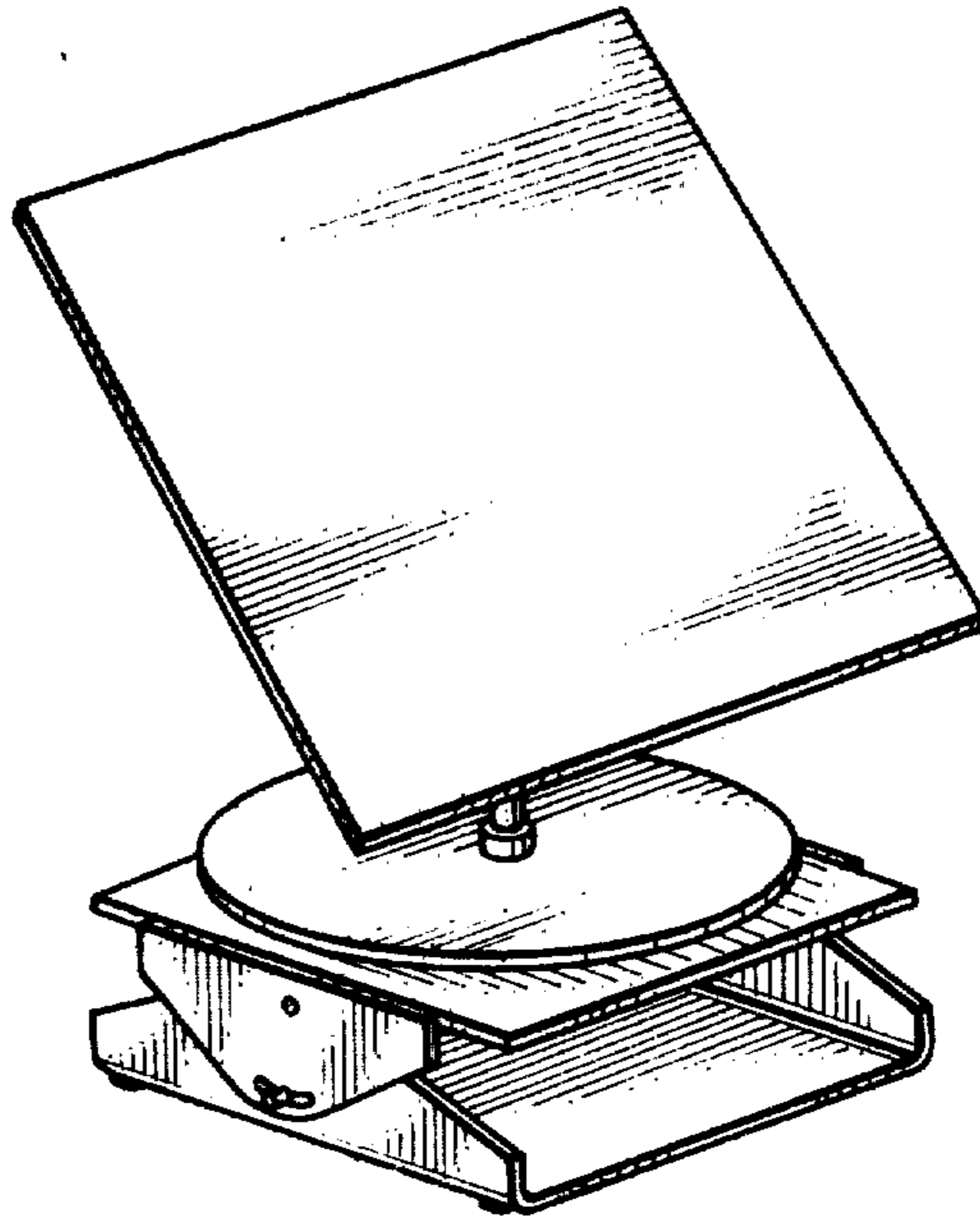
*Fig. 5.*



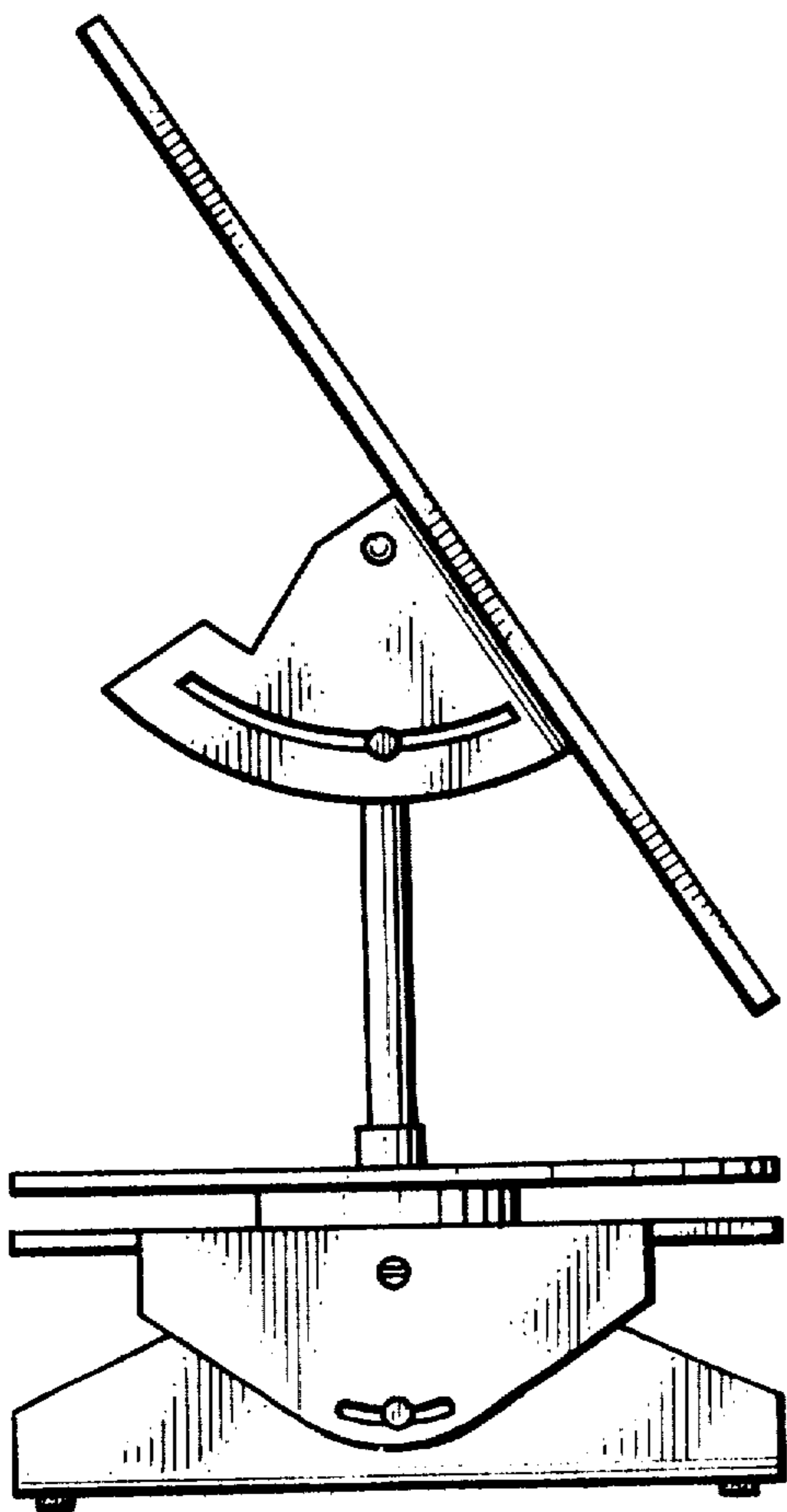
*Fig. 6.*



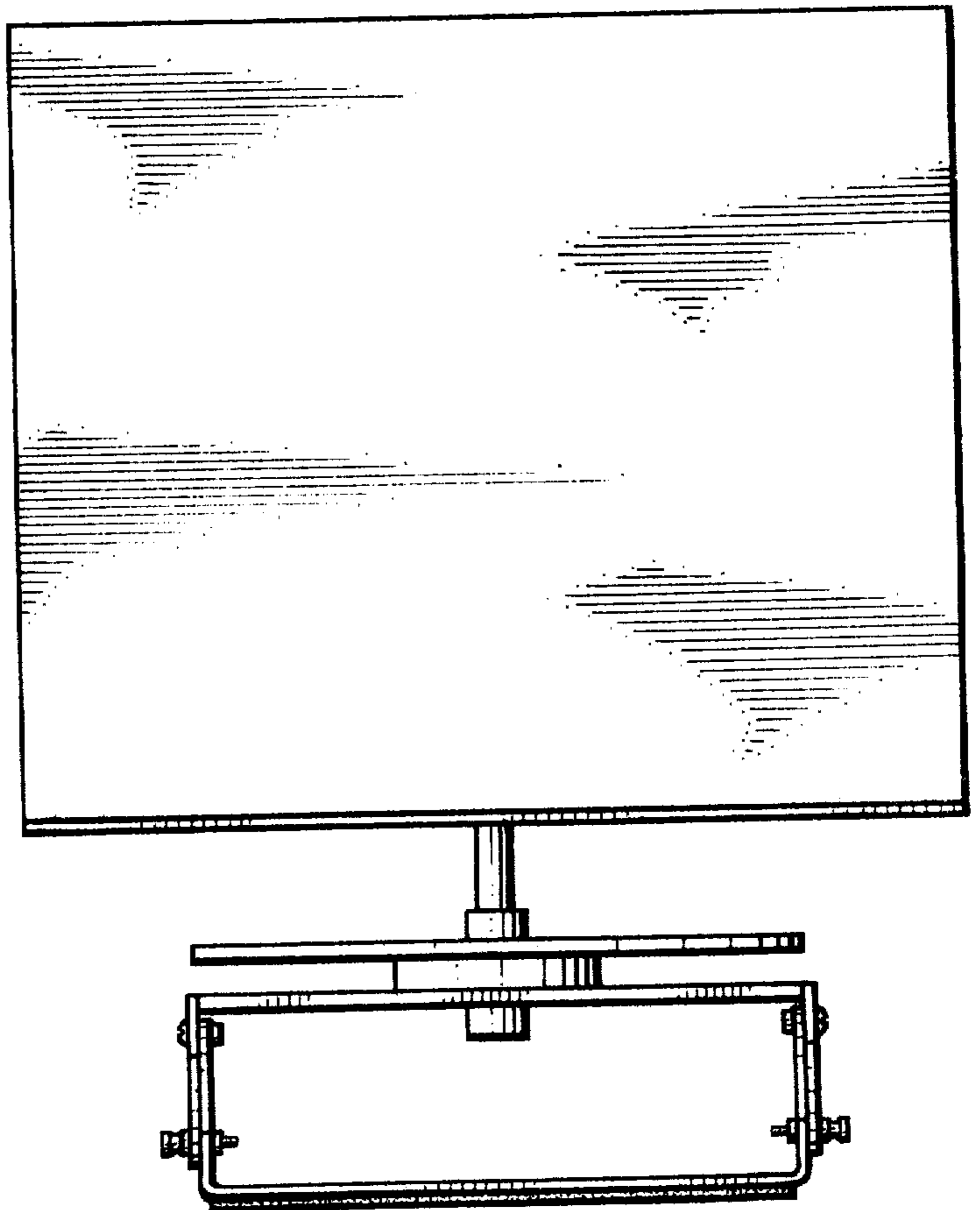
*Fig. 7.*



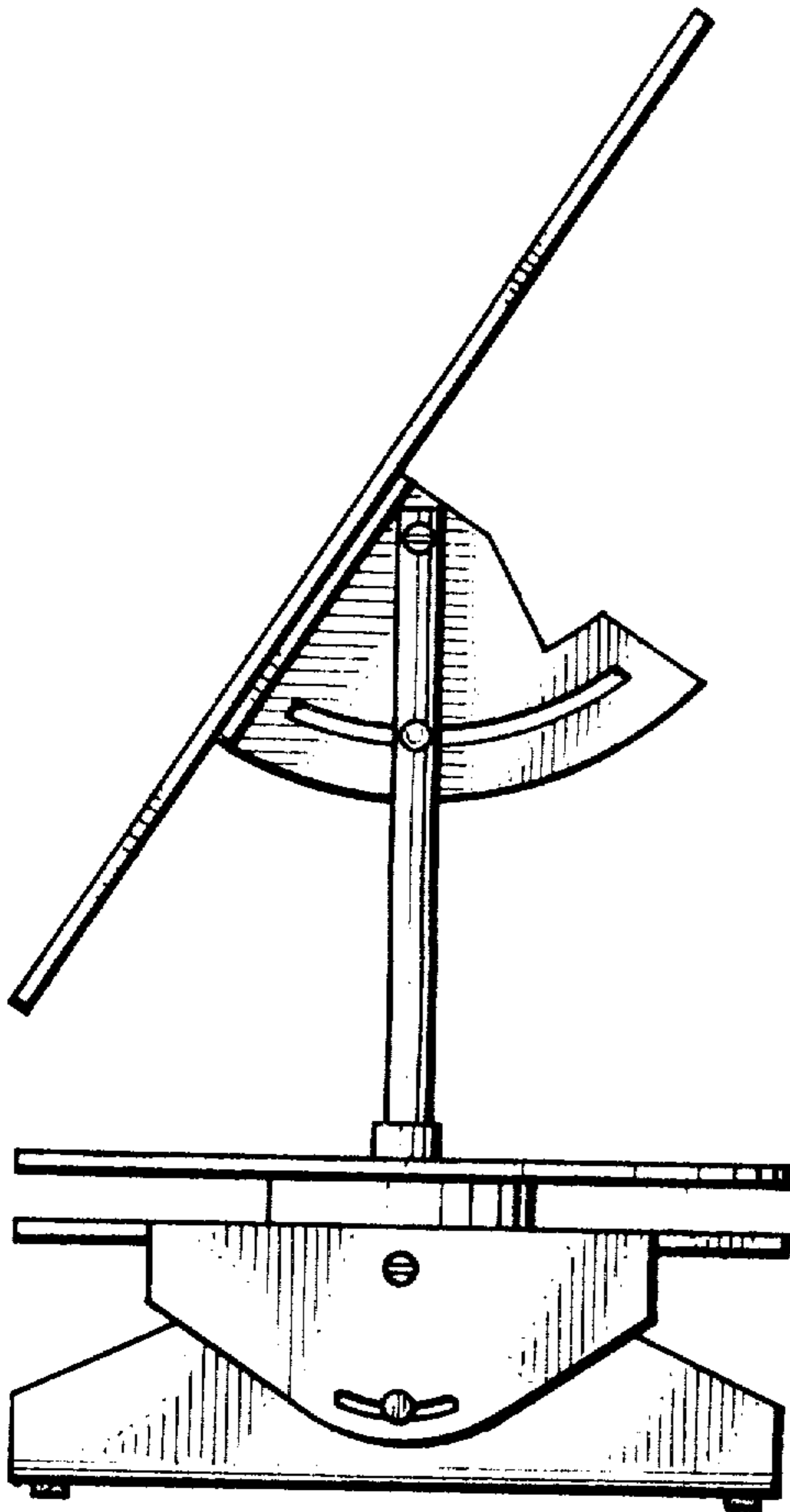
*Fig. 9.*



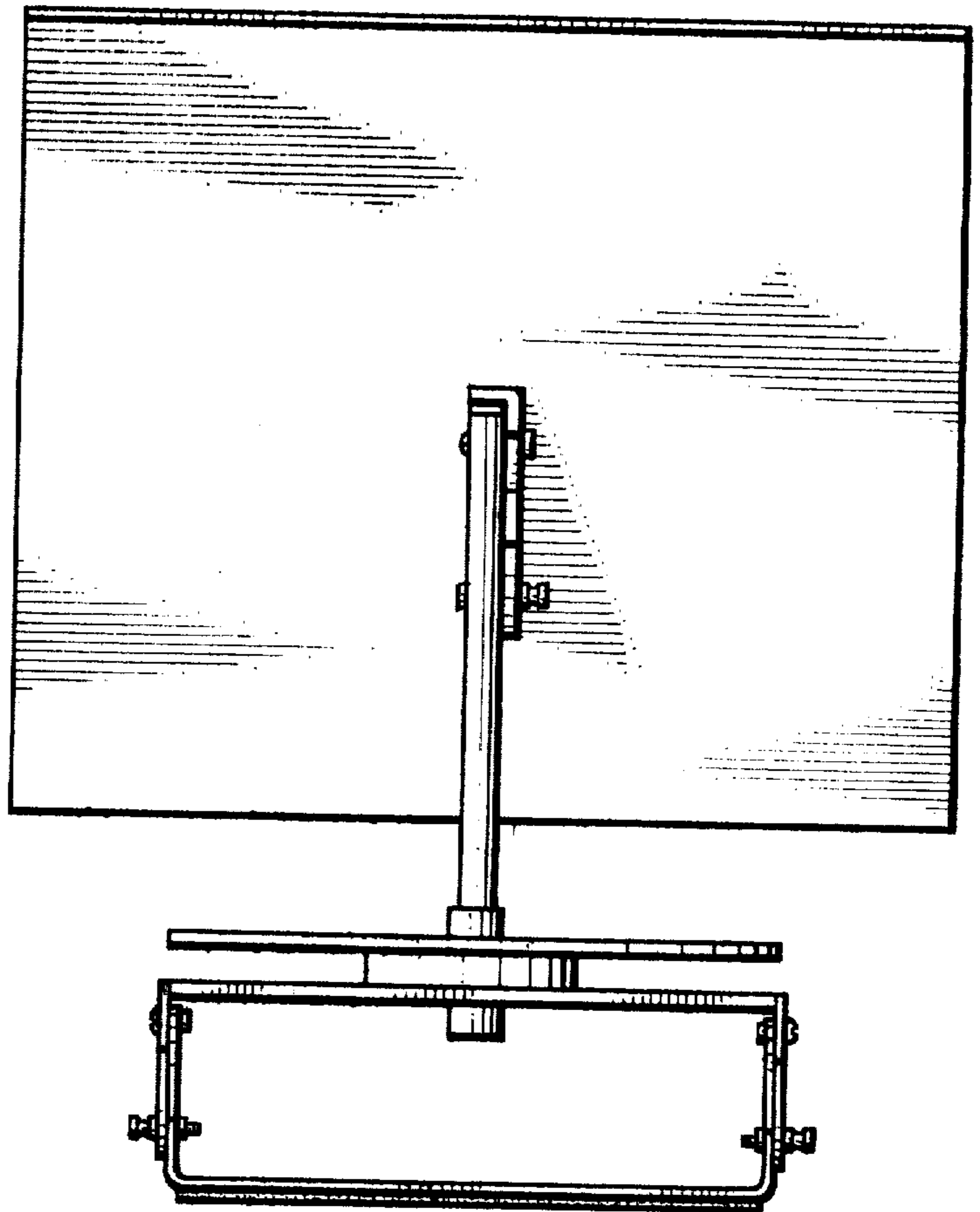
*Fig. 10.*



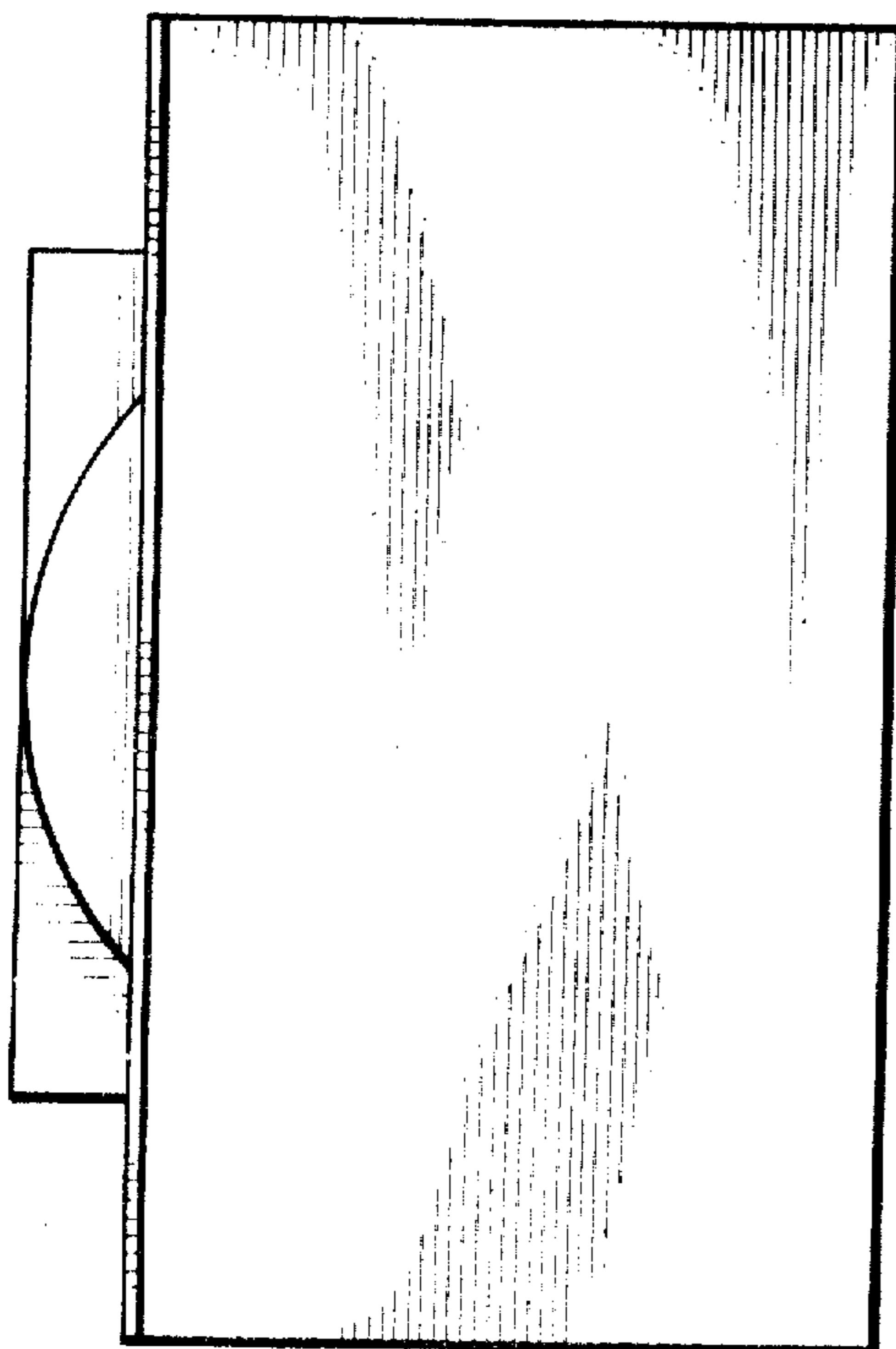
*Fig. 11.*



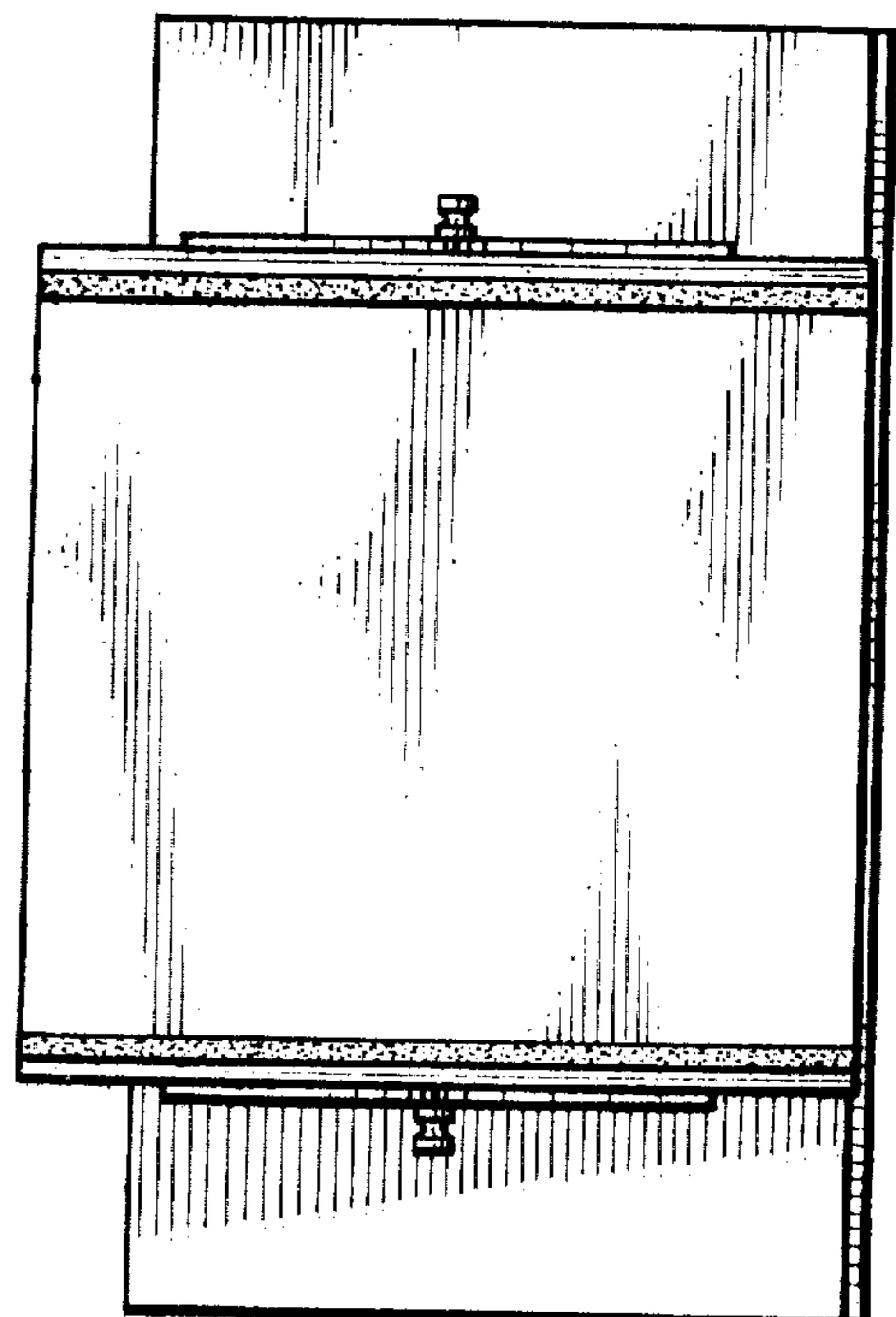
*Fig. 12.*



*Fig. 13.*



*Fig. 14.*



*Fig. 15.*