

[54] ADJUSTABLE COMMODE CHAIR

[76] Inventor: James W. Martin, Midlothian Country Club Grounds, Midlothian, Ill. 60445

[\*\*] Term: 14 Years

[21] Appl. No.: 266,941

[22] Filed: May 26, 1981

[51] Int. Cl. .... D23-02

[52] U.S. Cl. .... D23/48; D23/71

[58] Field of Search .... D23/48-50, D23/71; D6/48; 4/252 R, 254, 449, 450, 456, 457, 479, 480, 483; 248/421; 297/192, 193, 330

[56] References Cited

U.S. PATENT DOCUMENTS

- D. 190,555 6/1961 Weidner ..... D23/71
- D. 234,202 1/1975 Aldred ..... D23/71

- D. 260,583 9/1981 Brewer ..... D23/48 X
- D. 265,119 6/1982 Hurley ..... D23/48
- D. 267,618 5/1982 Hurley ..... D23/48
- 1,848,443 3/1932 Toops ..... 4/483
- 4,168,552 9/1979 Austin ..... 4/254 X
- 4,249,774 2/1981 Andreasson ..... 297/330 X

Primary Examiner—James R. Largen

[57] CLAIM

The ornamental design for an adjustable commode chair, substantially as shown and described.

DESCRIPTION

FIG. 1 is a right side elevational view of an adjustable commode chair showing my new design; FIG. 2 is a front elevational view thereof; FIG. 3 is a top plan view thereof; FIG. 4 is a rear elevational view thereof; FIG. 5 is a left side elevational thereof showing the chair in a lowered position; and FIG. 6 is a bottom plan view thereof.

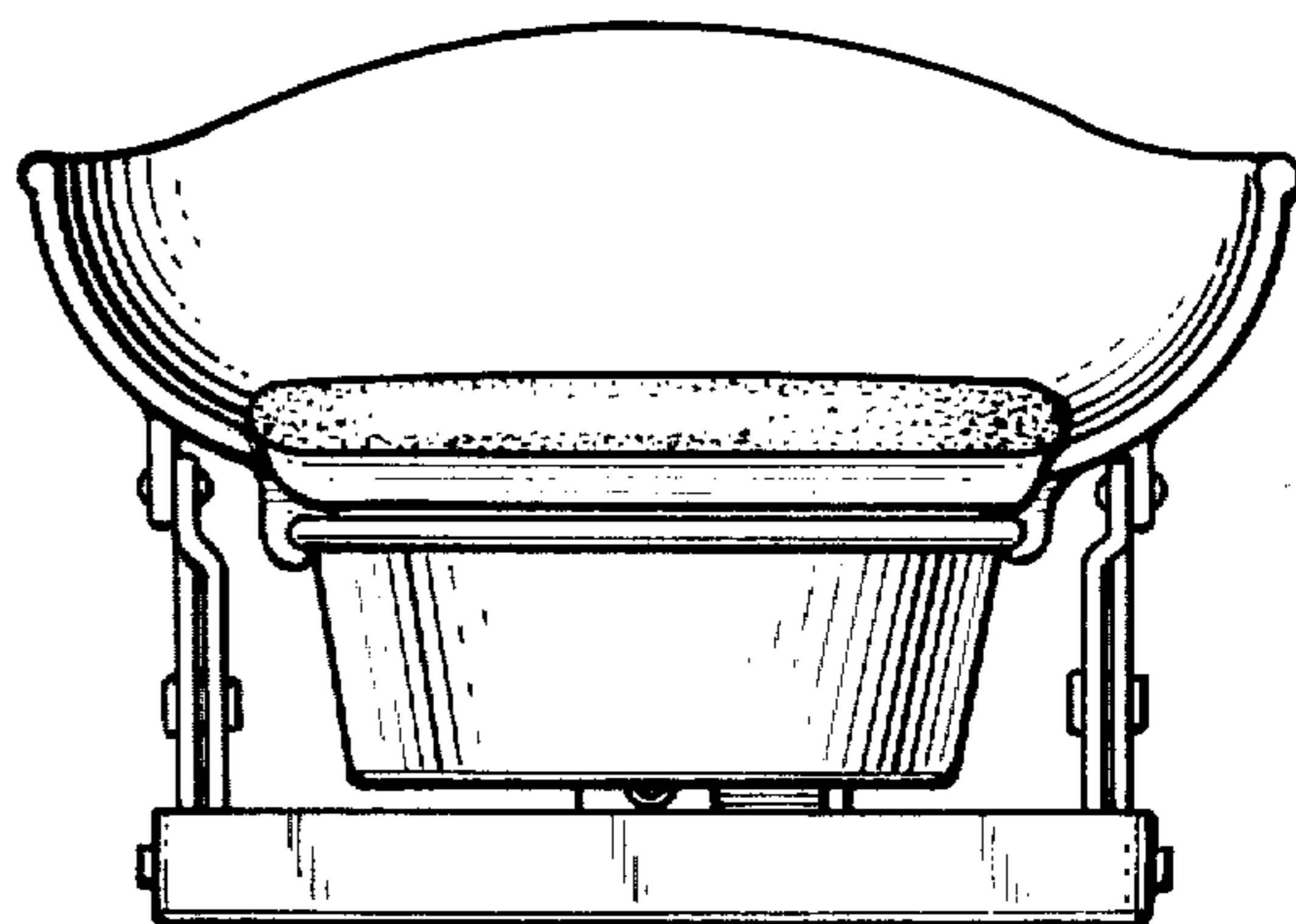
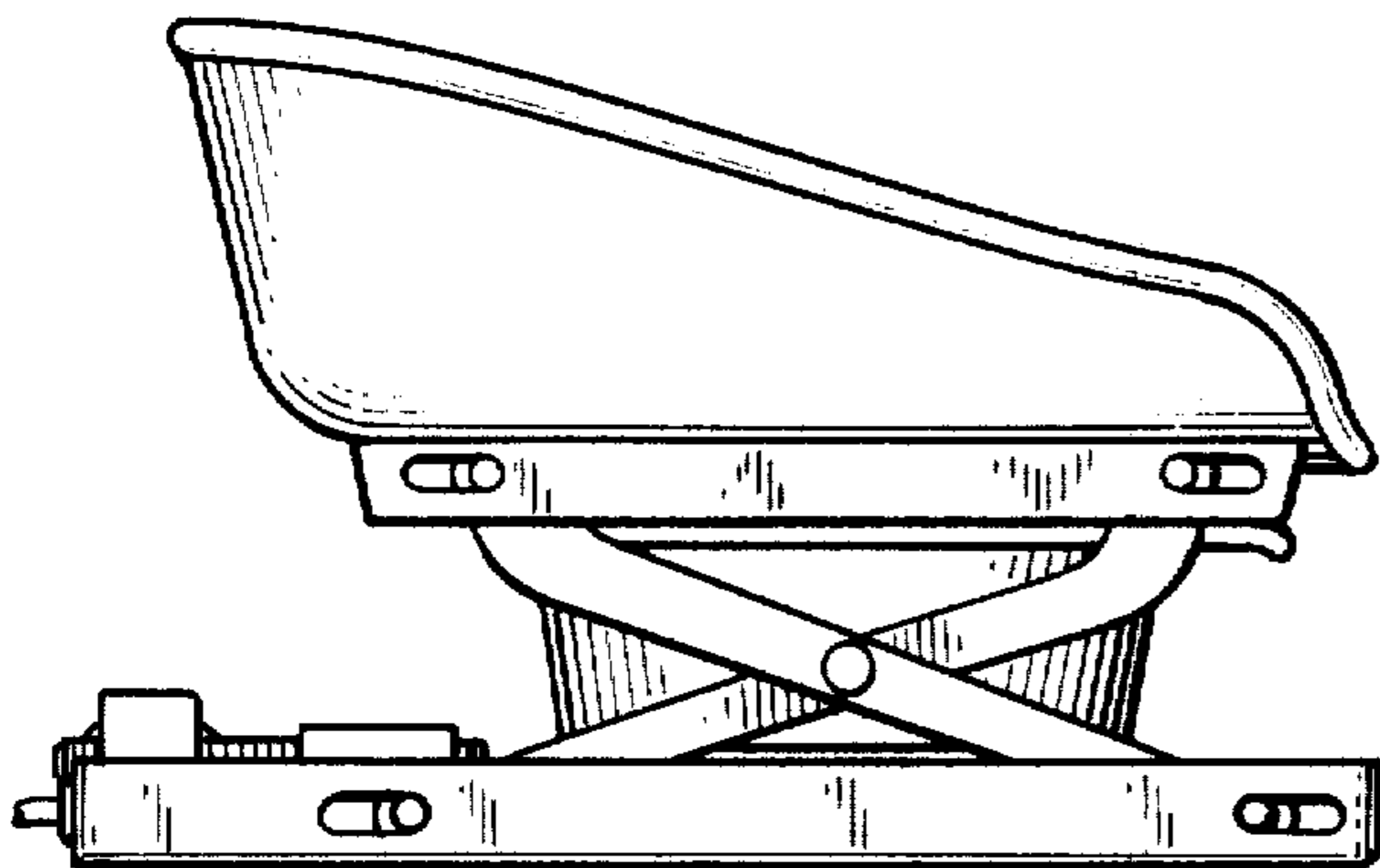

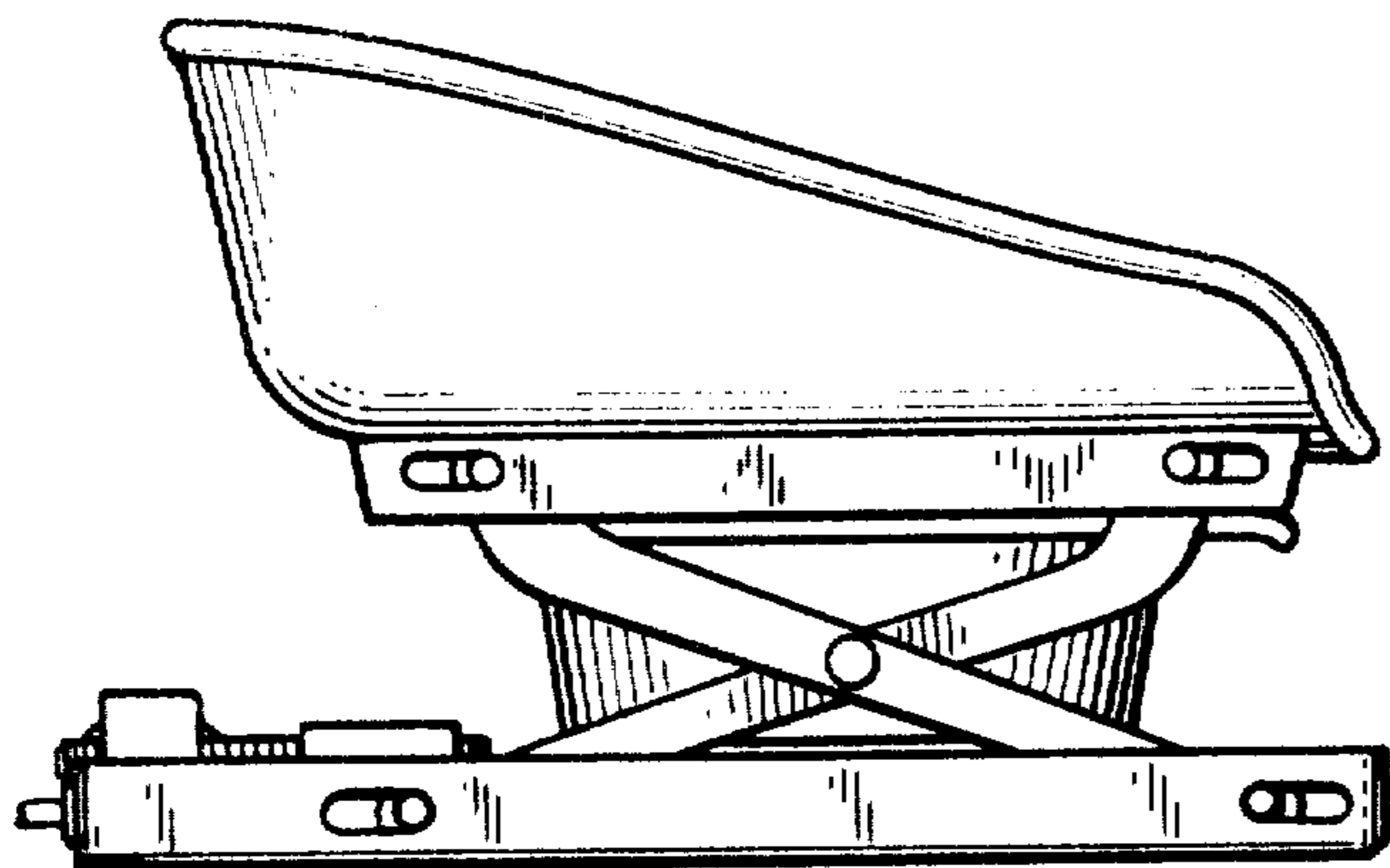

FIG. 1

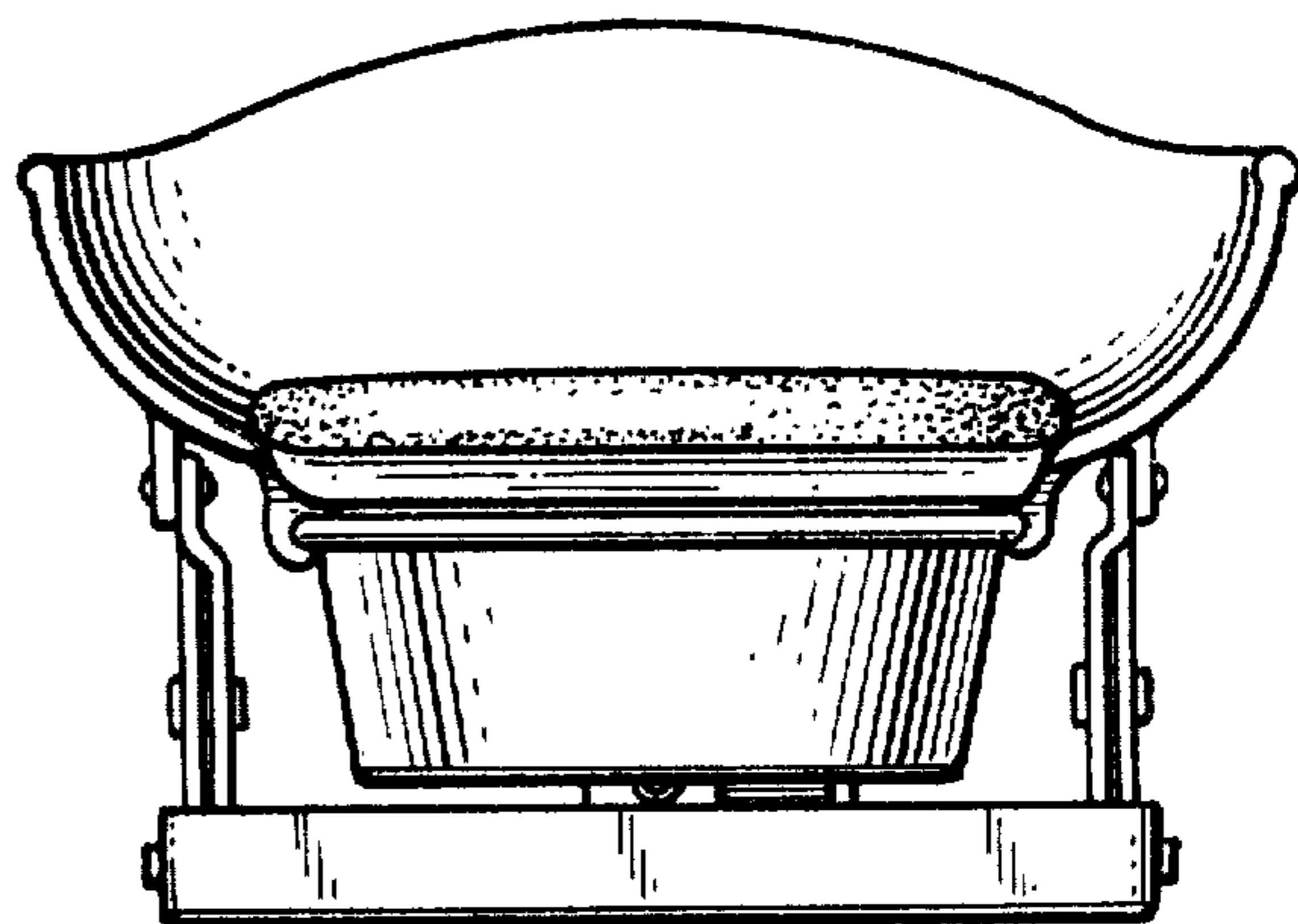

FIG. 2

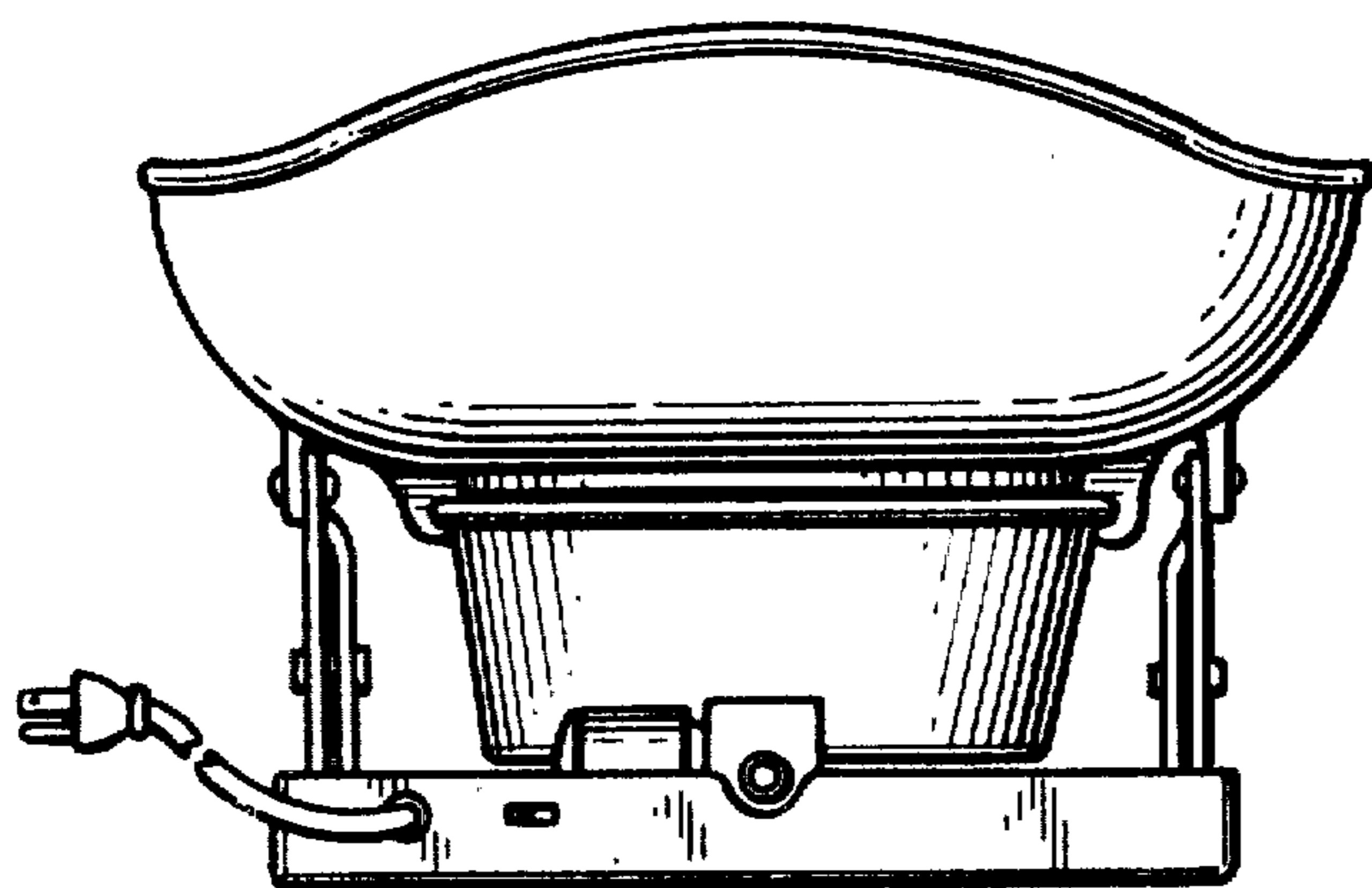

FIG. 4

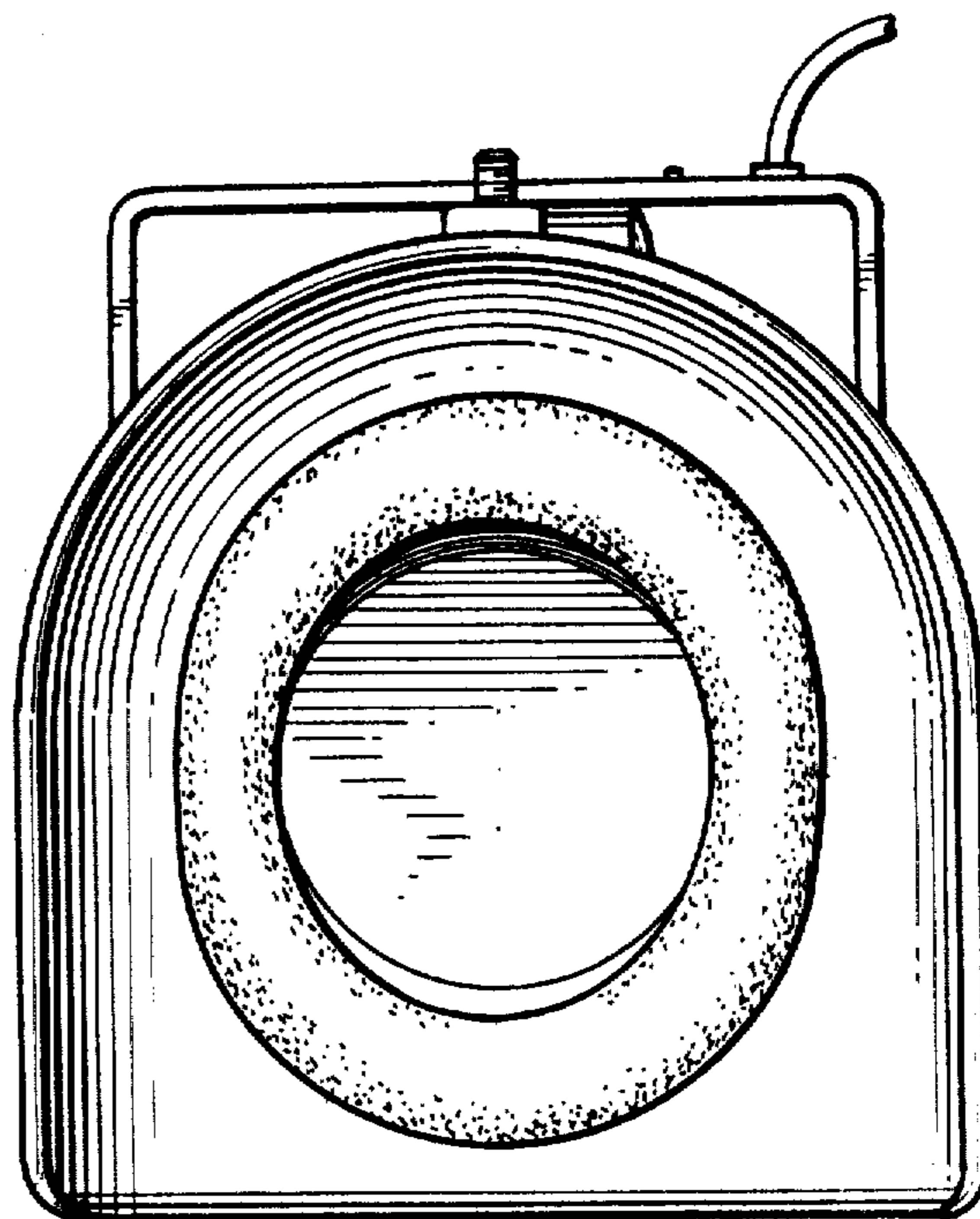

FIG. 3

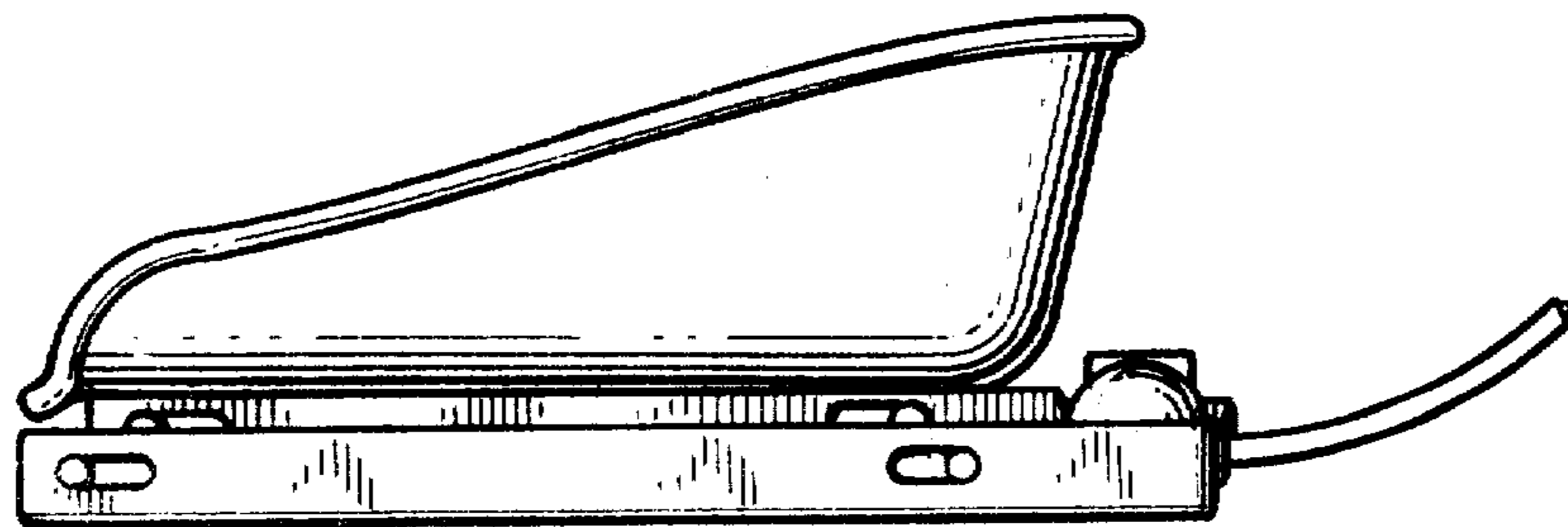

FIG. 5

FIG. 6

