

[54] HYDROTHERAPY SPA

[75] Inventors: Herbert V. Kohler, Jr., Kohler; Robert C. Giese, Jr., Sheboygan, both of Wis.

[73] Assignee: Kohler Company, Kohler, Wis.

[\*\*] Term: 14 Years

[21] Appl. No.: 261,960

[22] Filed: May 8, 1981

[51] Int. Cl. .... D24—01; D23—02

[52] U.S. Cl. .... D24/38; D25/02; D23/55

[58] Field of Search ..... D24/38; D23/55; D25/2; 4/513, 489, 506, 542, 492, 497, 524

[56] References Cited

U.S. PATENT DOCUMENTS

254,571	3/1980	Reineman	.....	D24/38
D. 260,429	8/1981	Myers	.....	D23/55 X
D. 261,426	10/1981	Reineman	.....	D23/55 X
D. 261,427	10/1981	Ogden	.....	D23/55 X
D. 267,272	12/1982	Doman et al.	.....	D24/38

OTHER PUBLICATIONS

Pp. 2 and 3 from an American Whirlpool Products Corp. advertising brochure, dated Oct., 1980, entitled "Whirlpool Tubs and Spas".

P. 4 of an American Leisure Corp. advertising brochure entitled "Whirlpool Baths".

P. 7 of an American Standard brochure entitled "America's Bathrooms Are Coming To Life!", dated Jan., 1980.

P. 1 of an Adams & Mercier brochure.

P. 6 of a scientific paper written by Charles Jones, delivered Aug. 1964 at meeting of the Society of Automotive Engineers.

Primary Examiner—Bernard Ansher

Attorney, Agent, or Firm—Quarles & Brady

[57] CLAIM

The ornamental design for a hydrotherapy spa, as shown.

DESCRIPTION

FIG. 1 is a top perspective view of a hydrotherapy spa showing our new design;

FIG. 2 is an alternative top perspective view thereof;

FIG. 3 is a further alternative top perspective view thereof;

FIG. 4 is a top plan view thereof;

FIG. 5 is a cross-section taken on line 5—5 of FIG. 4;

FIG. 6 is a fragmentary cross-section taken on line 6—6 of FIG. 4; and

FIG. 7 is a fragmentary cross-section taken on line 7—7 of FIG. 4.

The fragmentary broken lines representing the bathroom island installation are shown for illustrative purposes only.

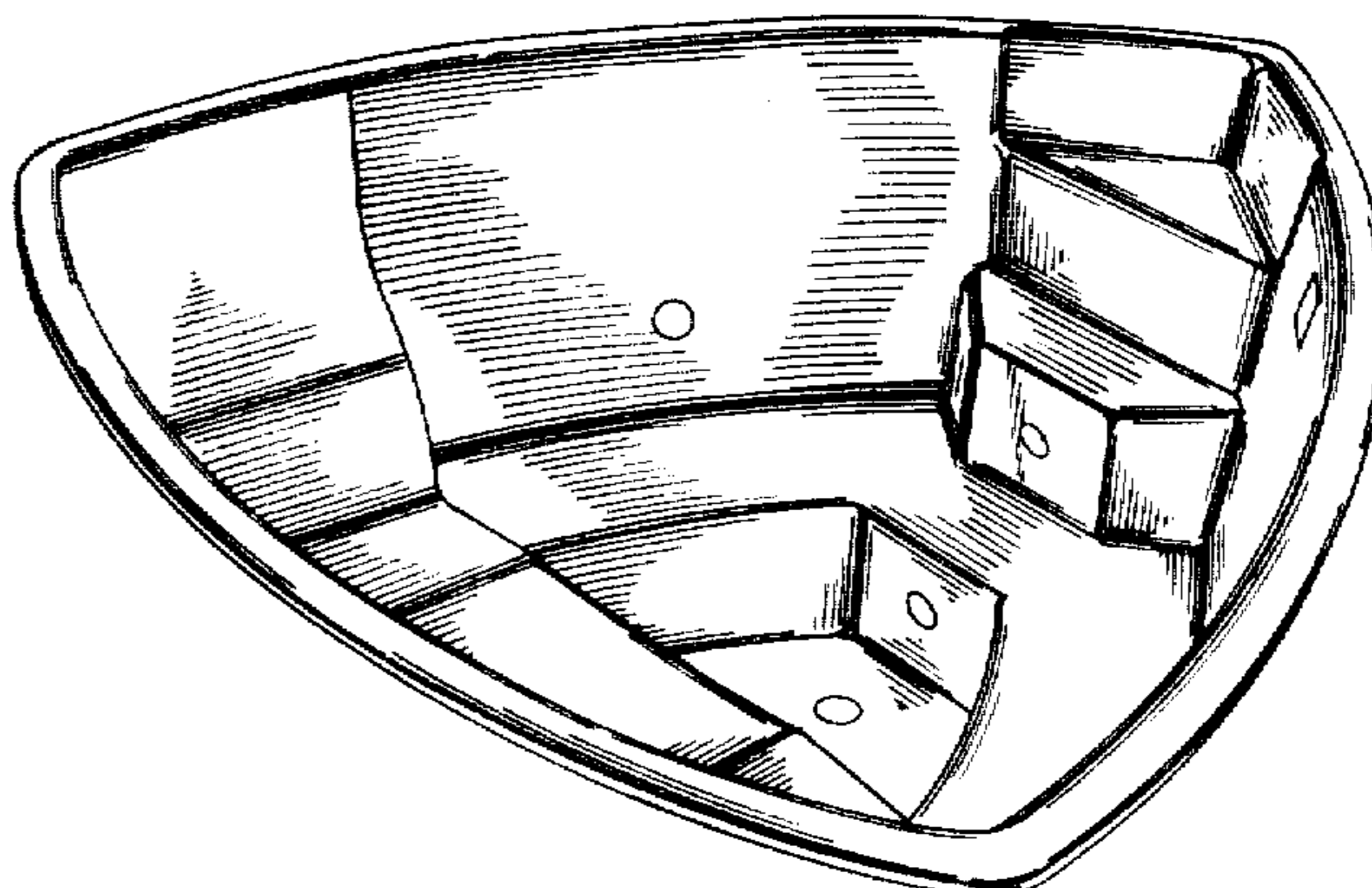
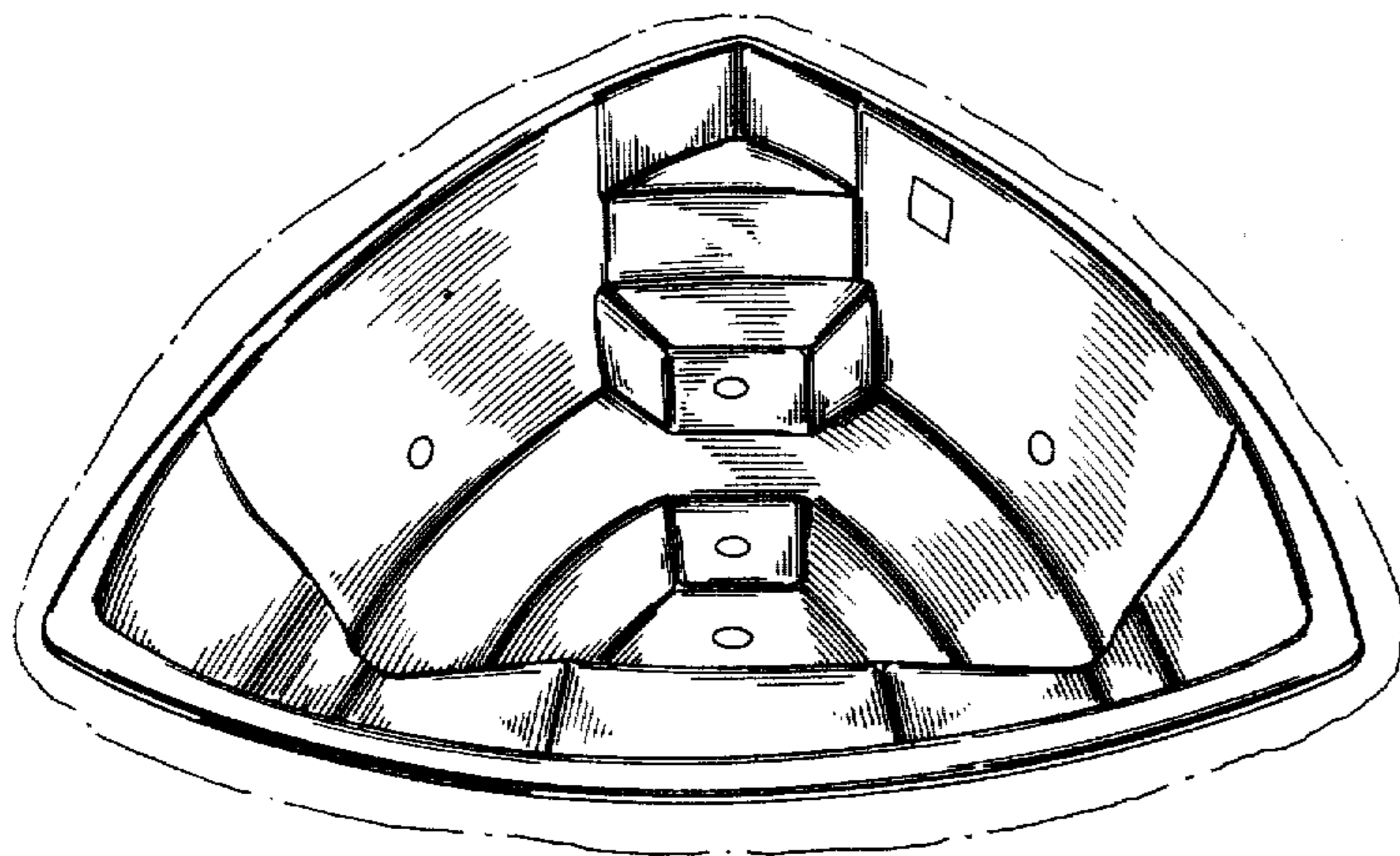

FIG. 1

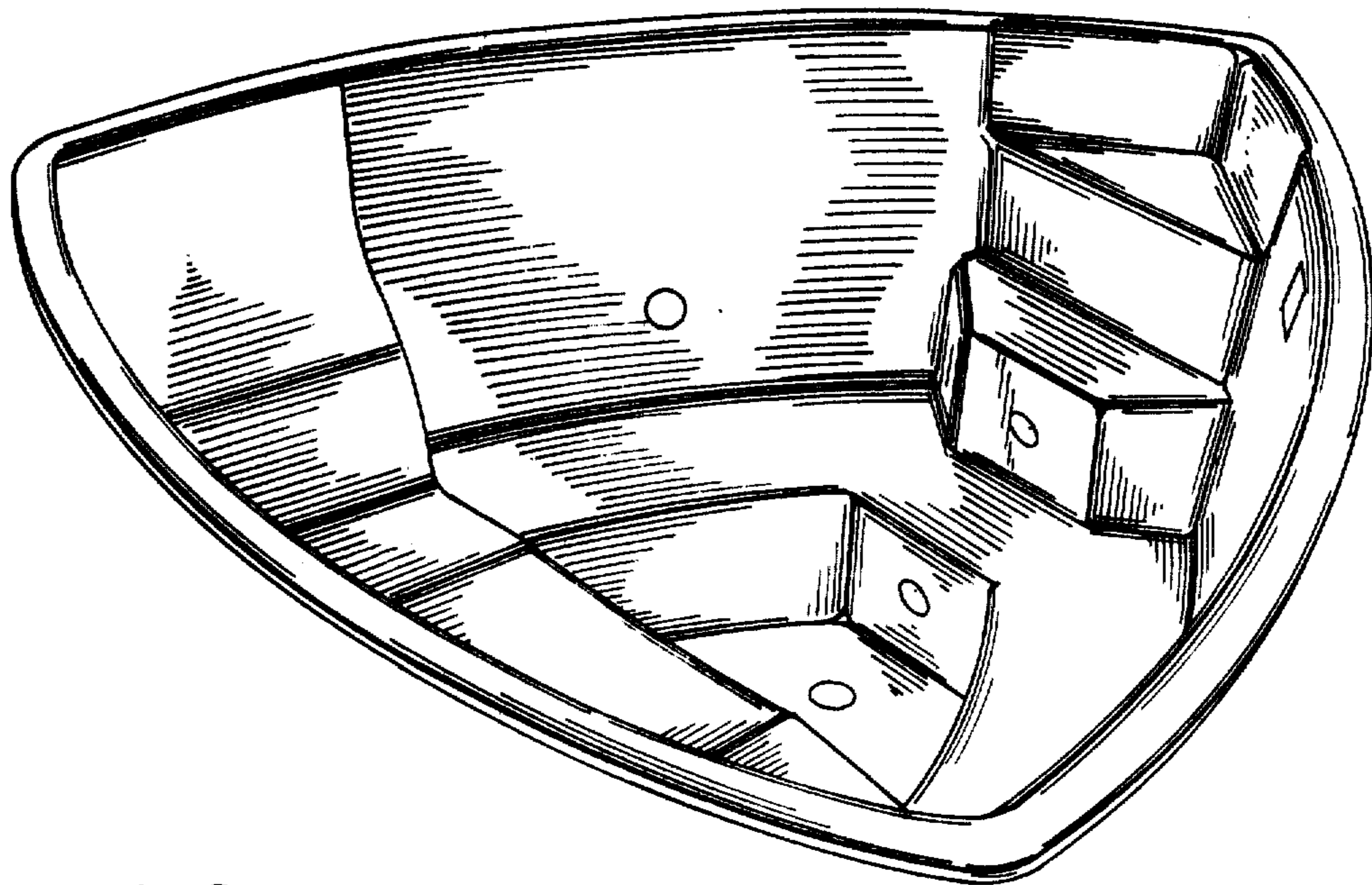
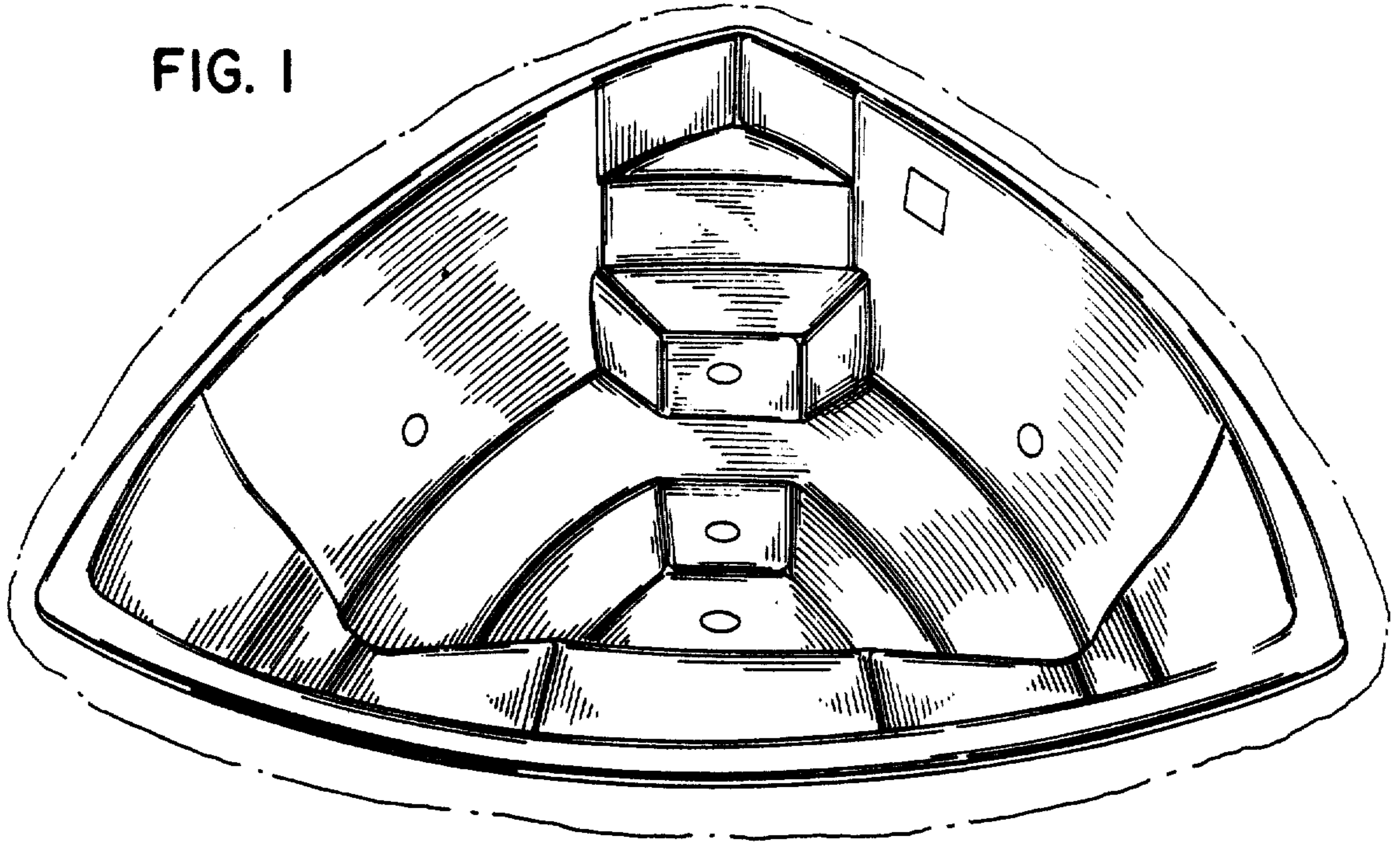

FIG. 2

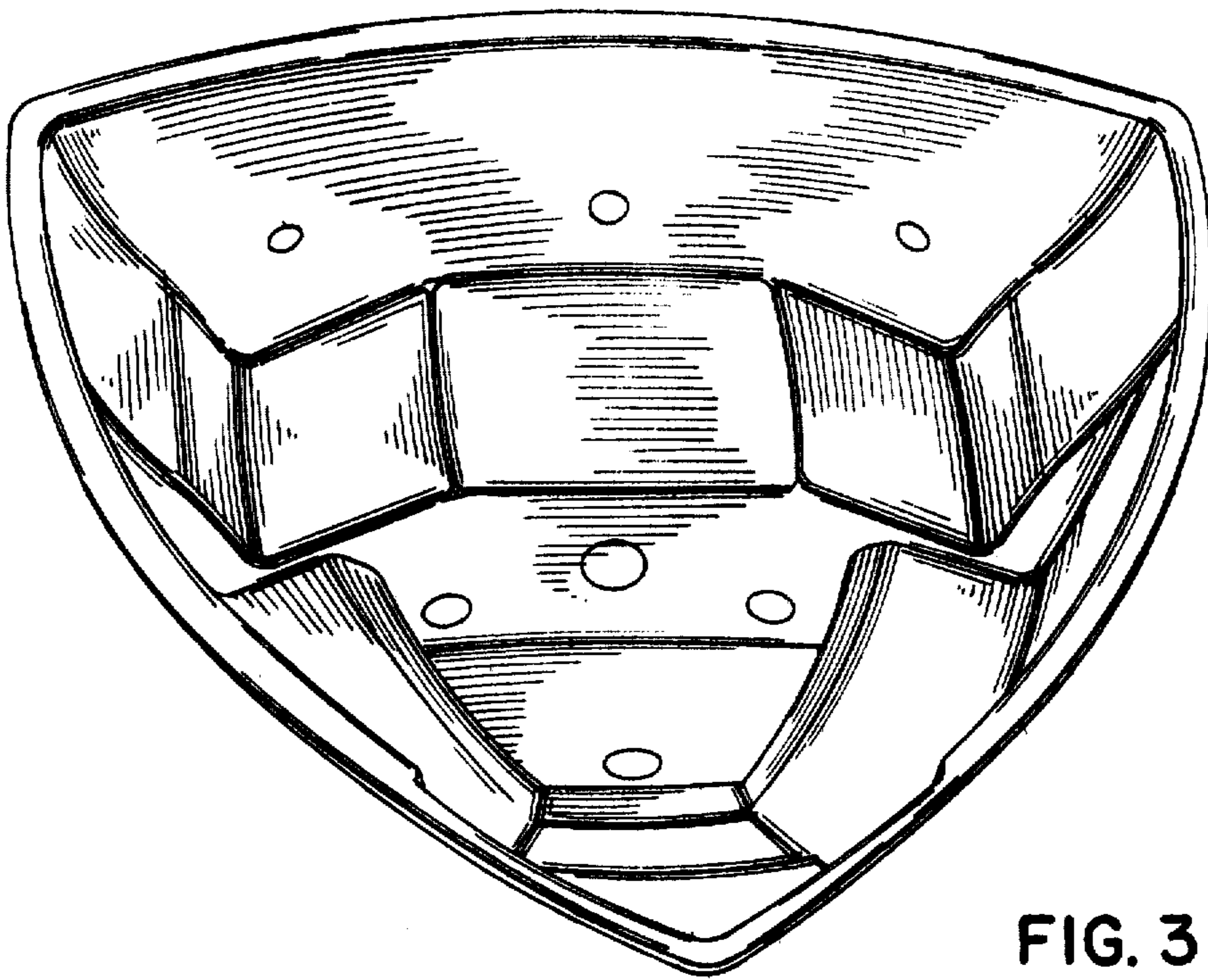

FIG. 3

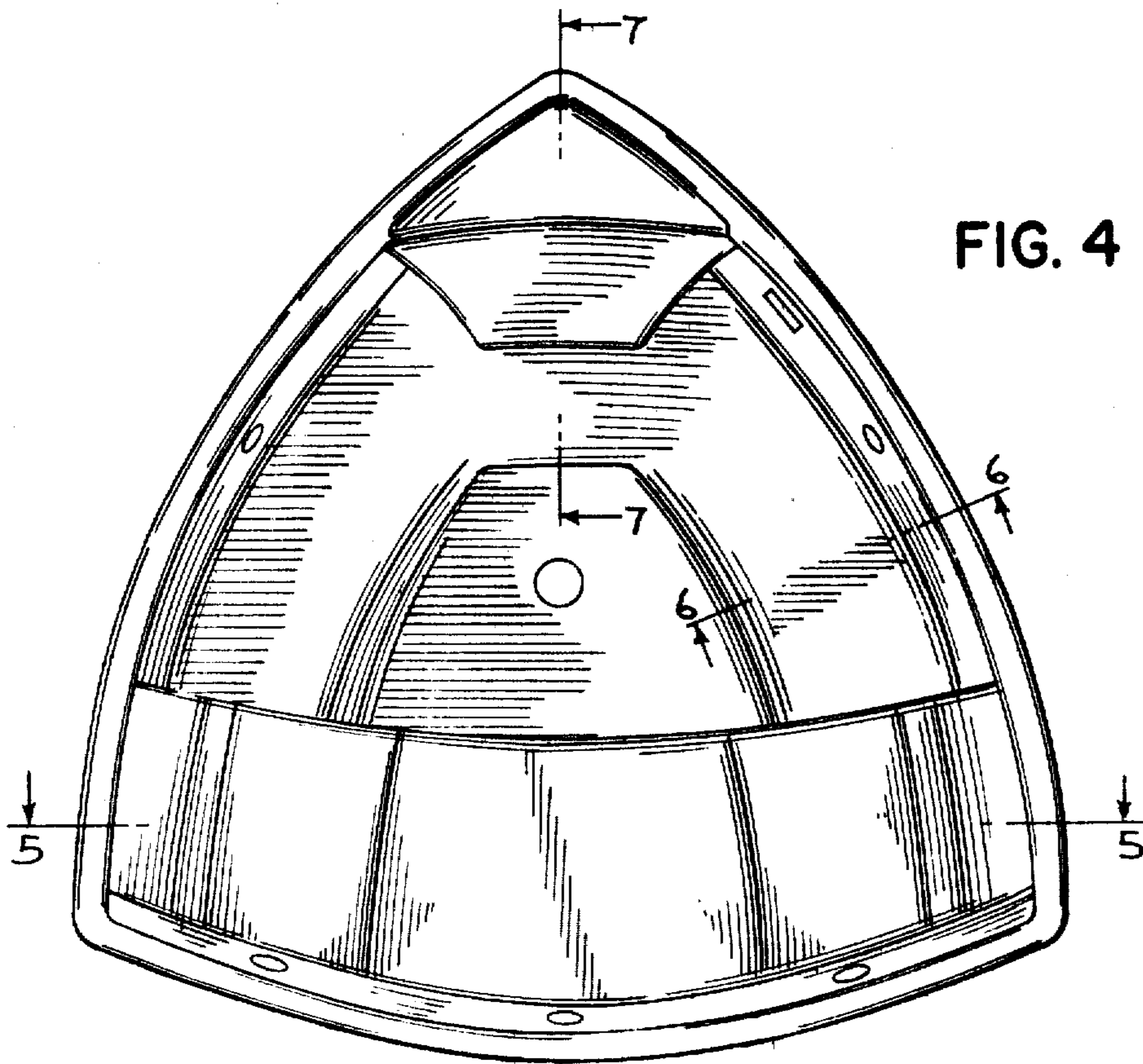

FIG. 4

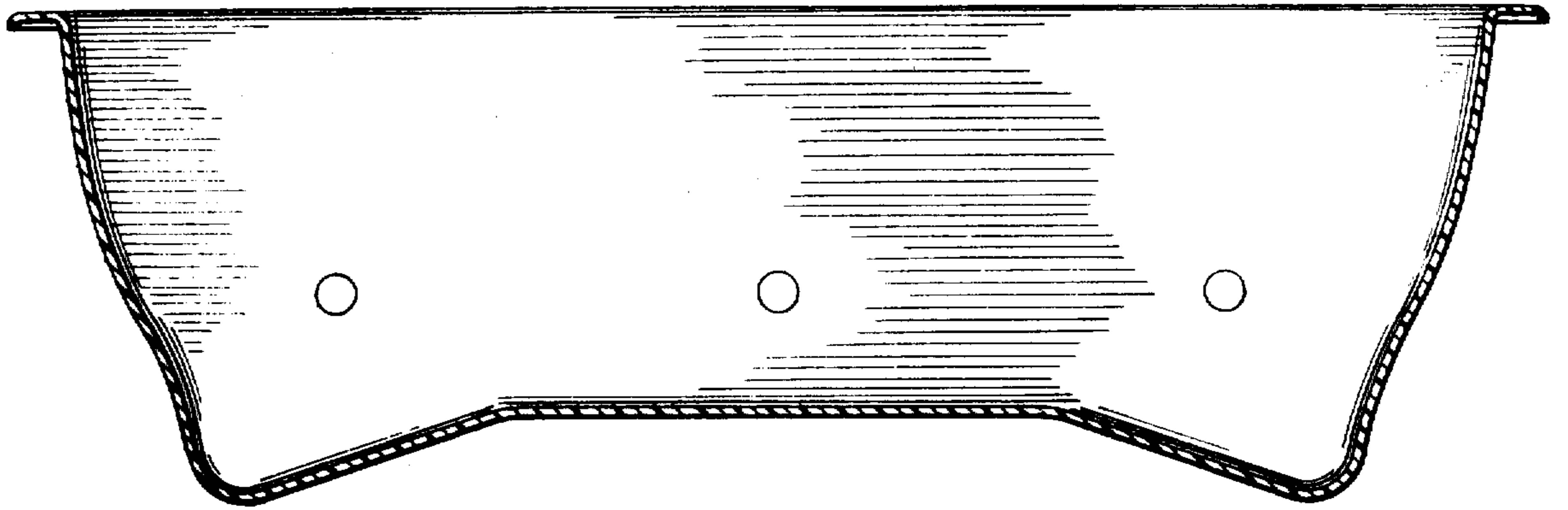

FIG. 5

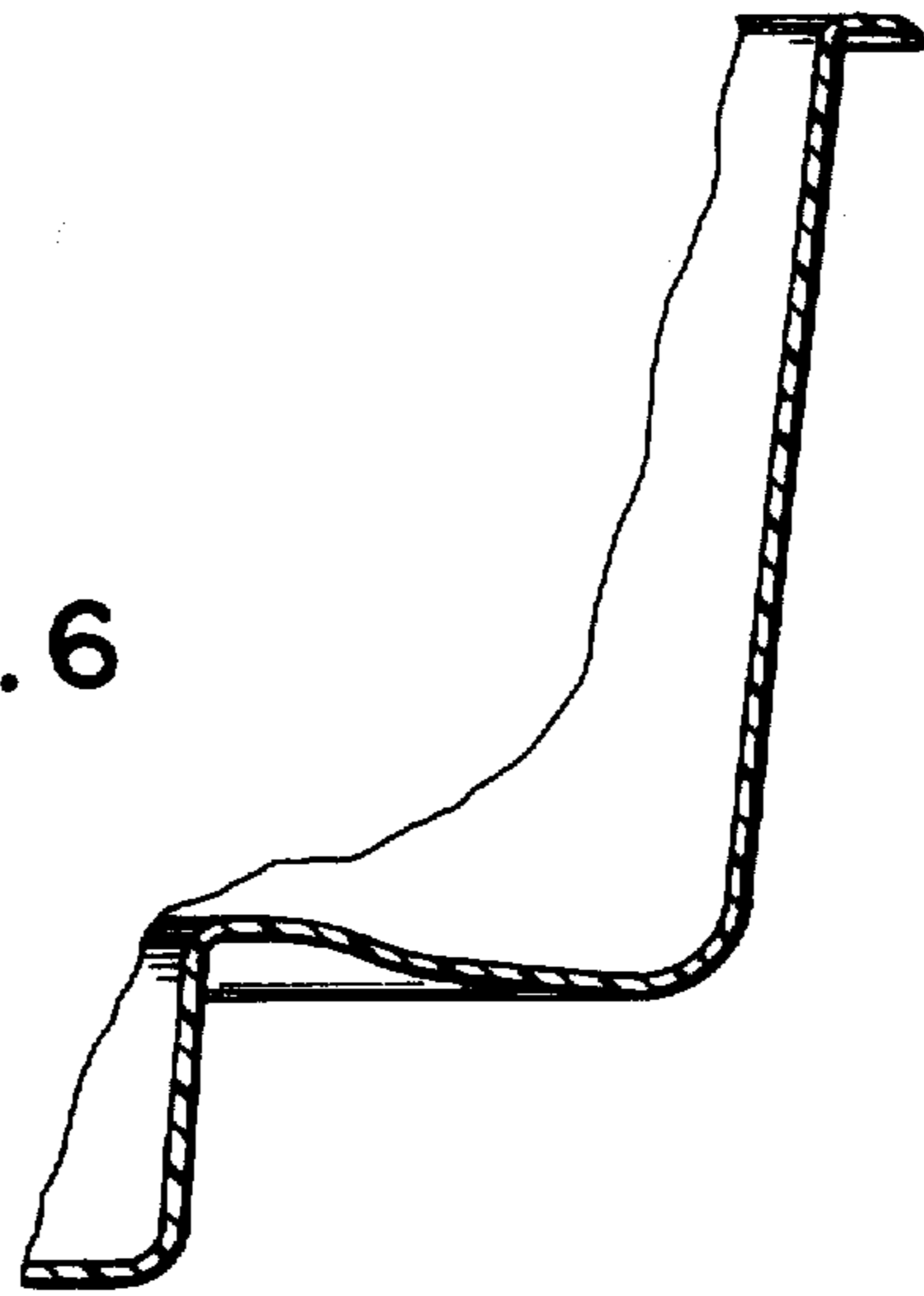

FIG. 6

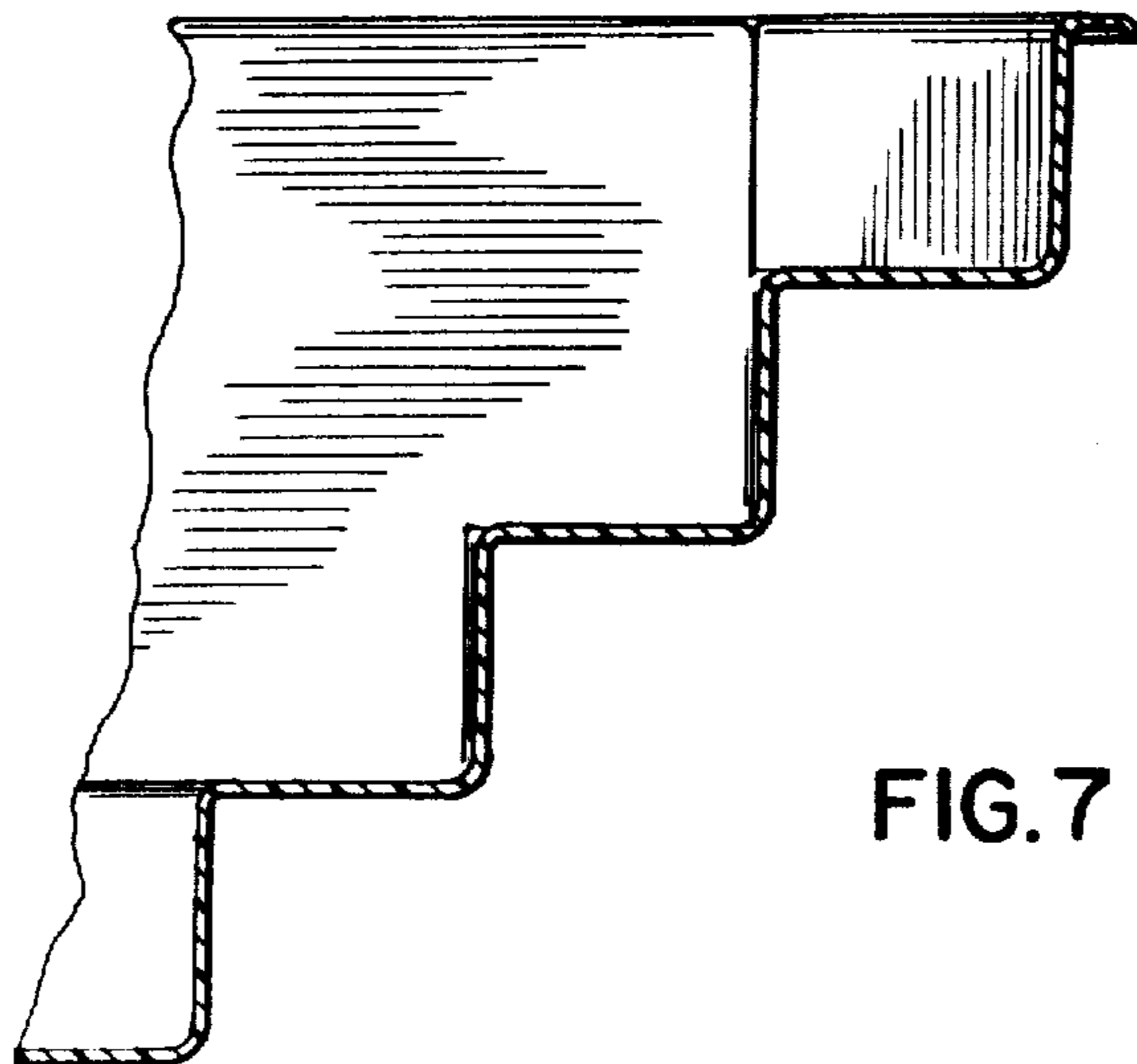

FIG. 7