

[54] COMPACTLY STACKABLE ARMCHAIR

[76] Inventor: David L. Rowland, 8 E. 62nd St., New York, N.Y. 10021

[**] Term: 14 Years

[21] Appl. No.: 272,982

[22] Filed: Jun. 10, 1981

[51] Int. Cl. D6-01

[52] U.S. Cl. D6/73; D6/78

[58] Field of Search D6/37-39, D6/47-78; 297/56, 445, 457, 458

[56] References Cited

U.S. PATENT DOCUMENTS

D. 117,964	12/1939	Smith	D6/73
D. 180,722	7/1957	Rowland	D6/77
D. 255,625	7/1980	Lübke	D6/73
D. 262,168	12/1981	Lustig	D6/73
3,709,559	1/1973	Rowland	D6/47 X
4,105,244	8/1978	Colby	D6/69 X

OTHER PUBLICATIONS

Brown/Jordan Cat. ©1976, p. 31, Chair No. 1080-5000, top left.

Primary Examiner—Bruce W. Dunkins
Attorney, Agent, or Firm—Owen, Wickersham & Erickson

[57] CLAIM

The ornamental design for an armchair, substantially as shown and described.

DESCRIPTION

FIG. 1 is a perspective view, looking from above and from the front and side at about a 45° angle, of an armchair embodying my new design.

FIG. 2 is a perspective view thereof, looking from above and from the rear and one side.

FIG. 3 is a perspective view thereof, looking down from one side.

FIG. 4 is a perspective view thereof, looking from the front and one side.

FIG. 5 is a perspective view, looking down from above and from the front.

FIG. 6 is a bottom view thereof.

FIG. 7 is a perspective view, looking down on the front and one side of a modified form of compactly stackable armchair also embodying my new design.

FIG. 8 is a perspective view of the armchair of FIG. 7, looking down upon from the rear and one side.

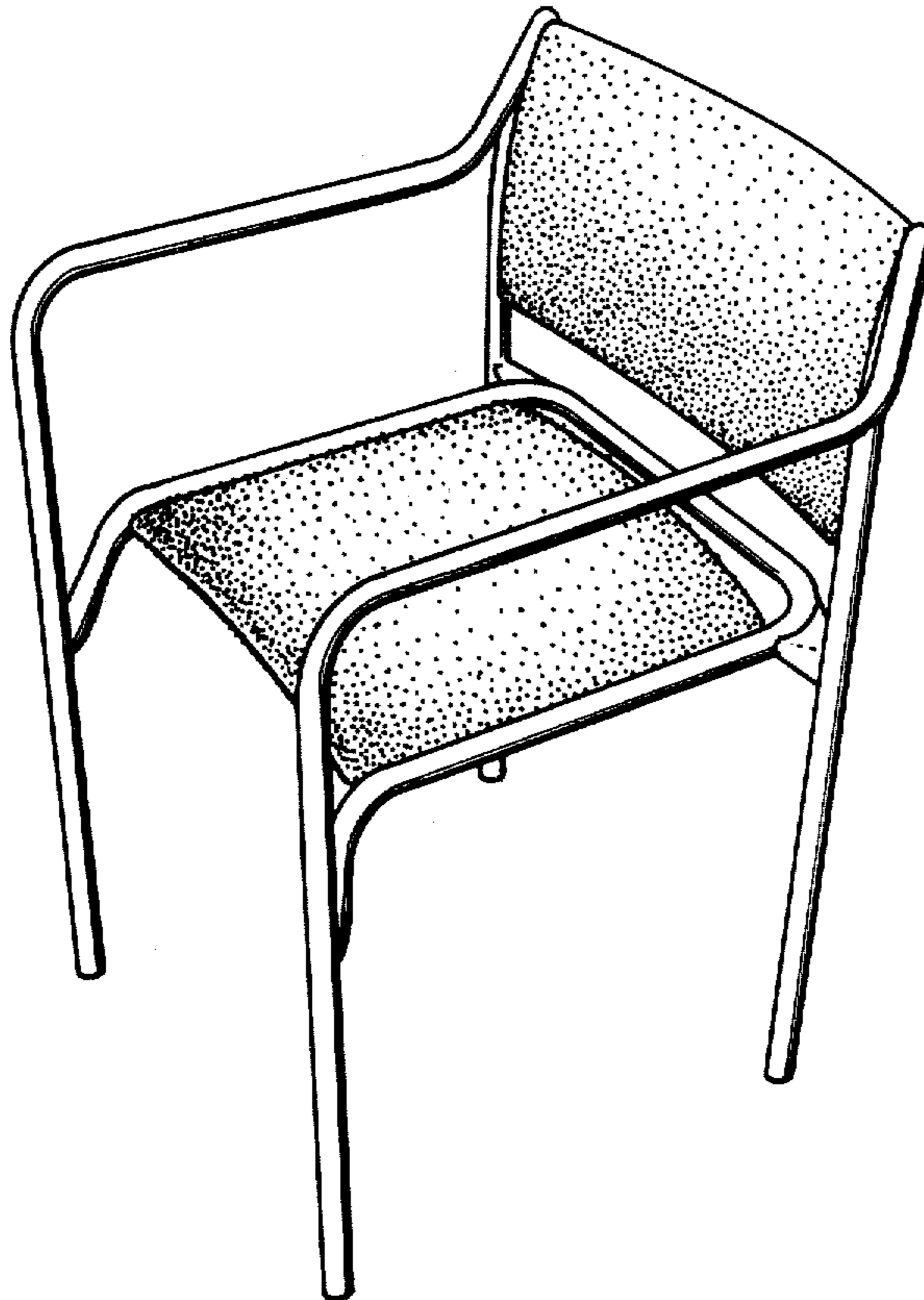

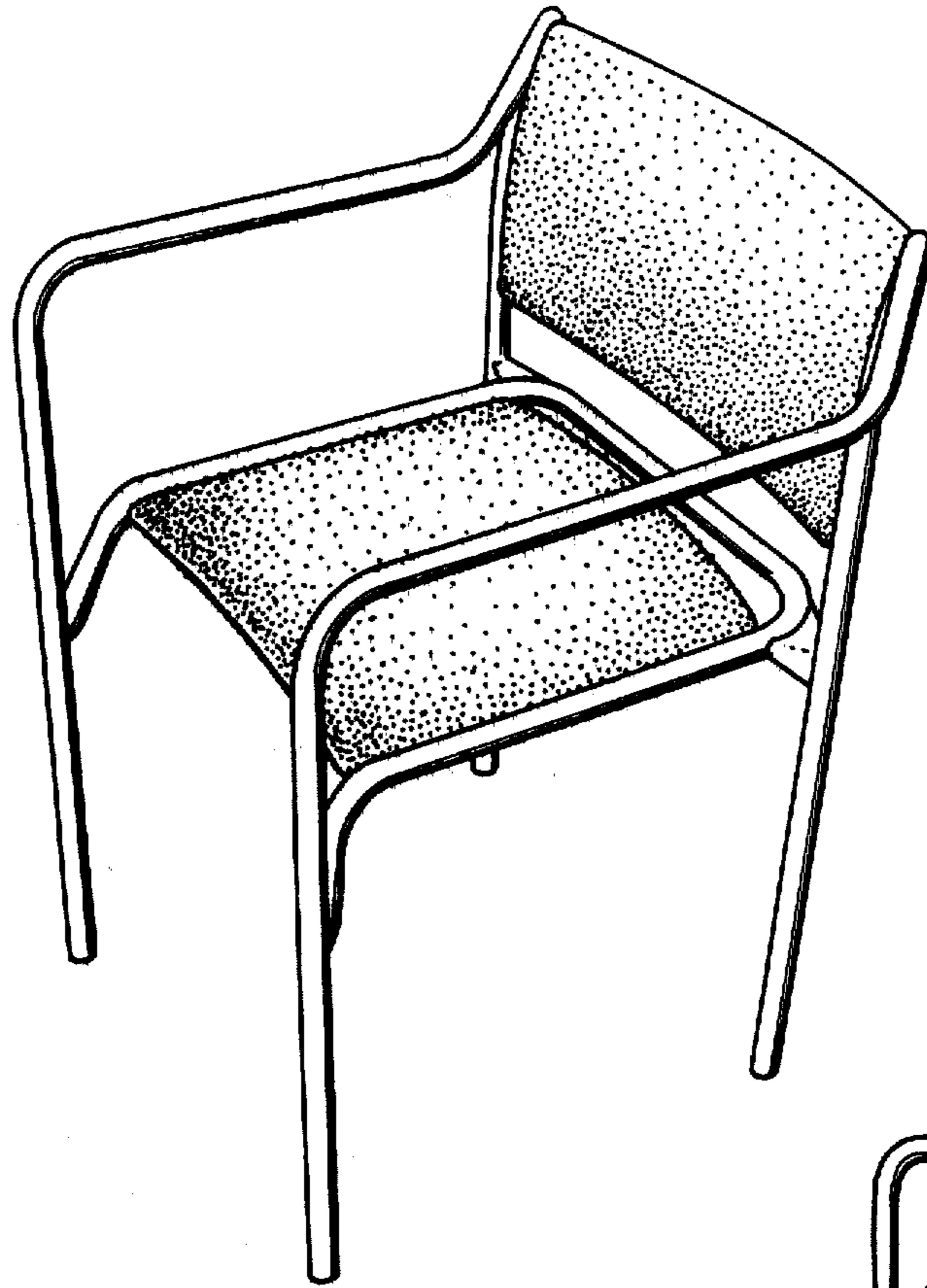

FIG. 1

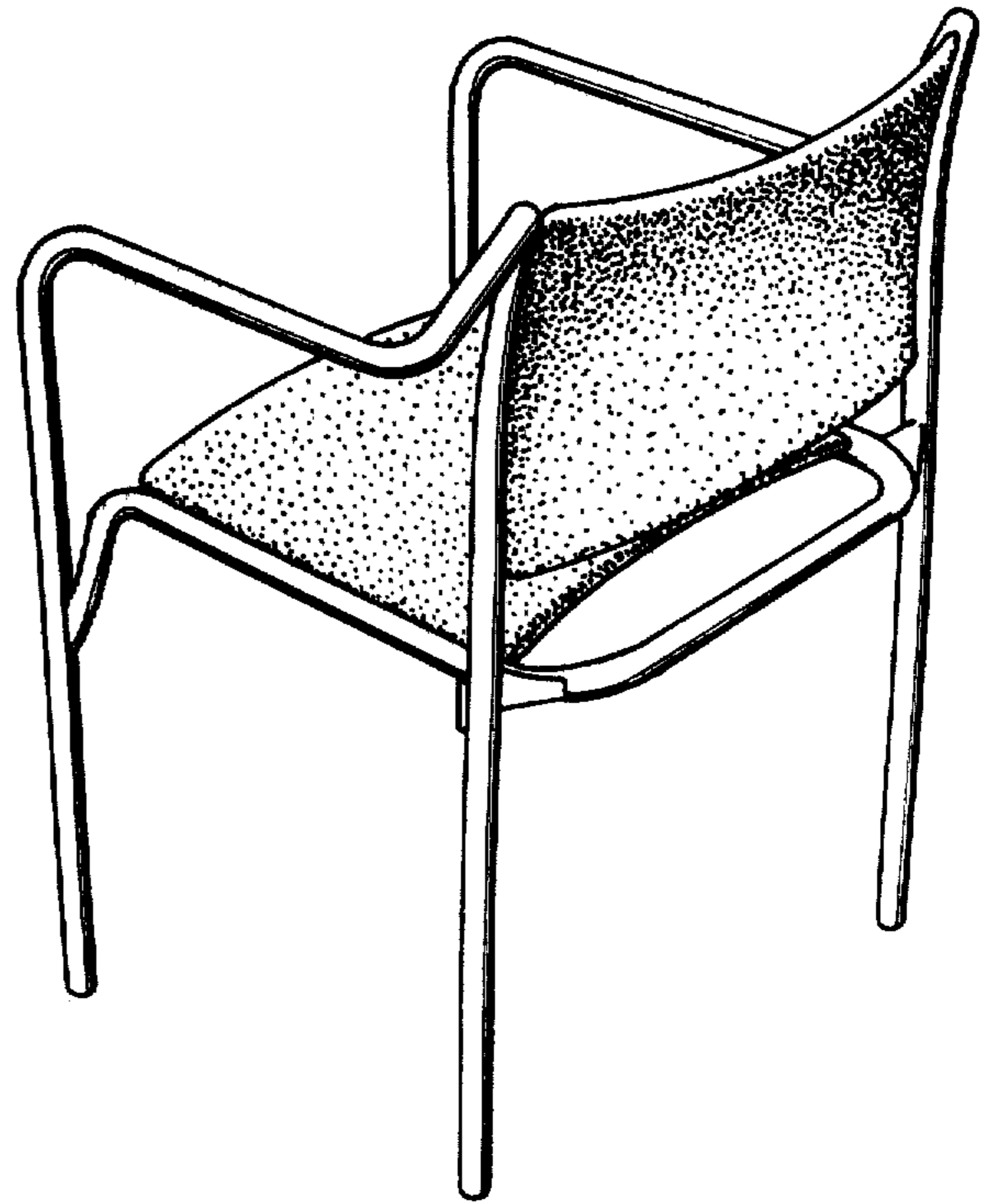

FIG. 2

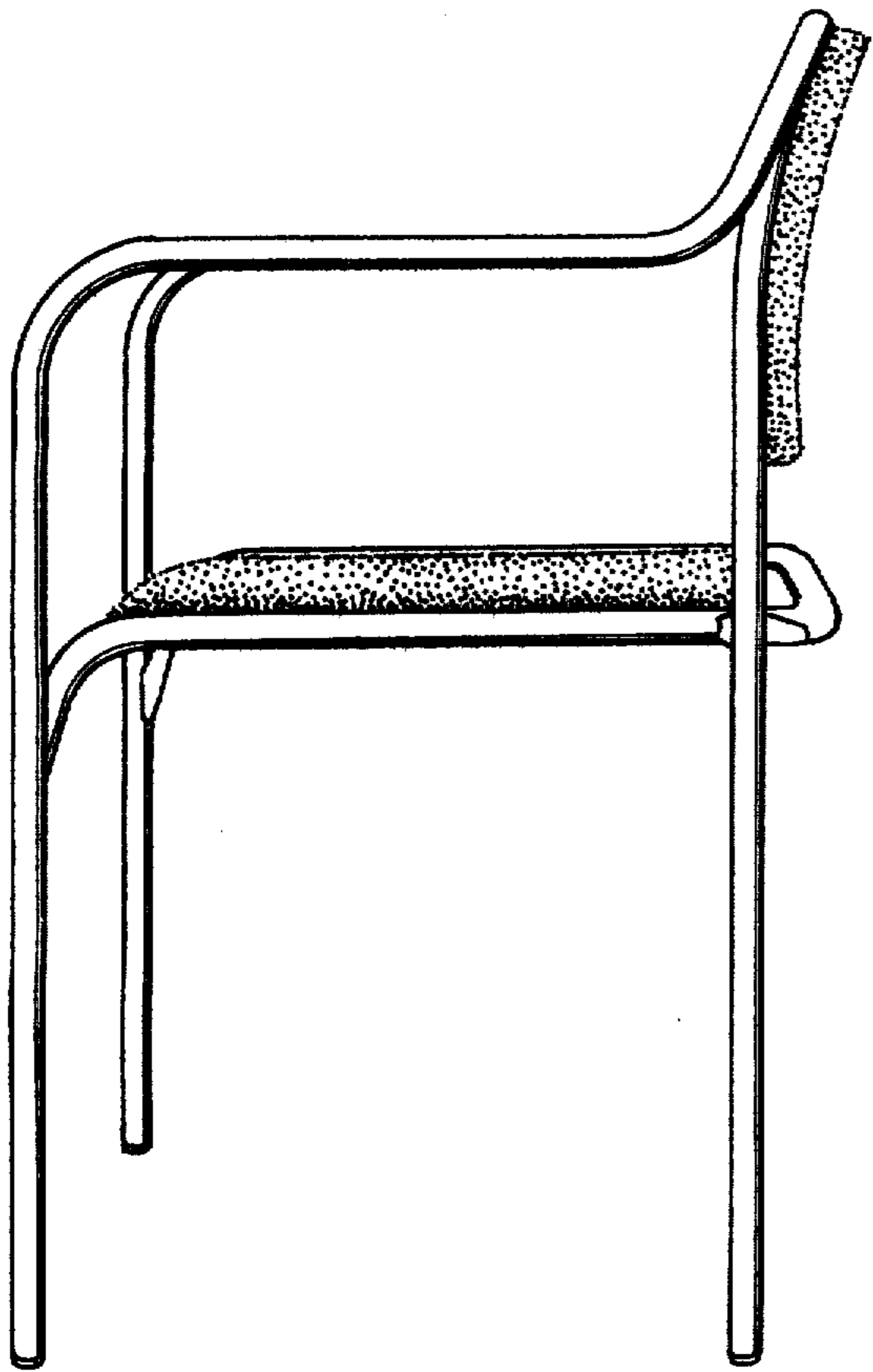

FIG. 3

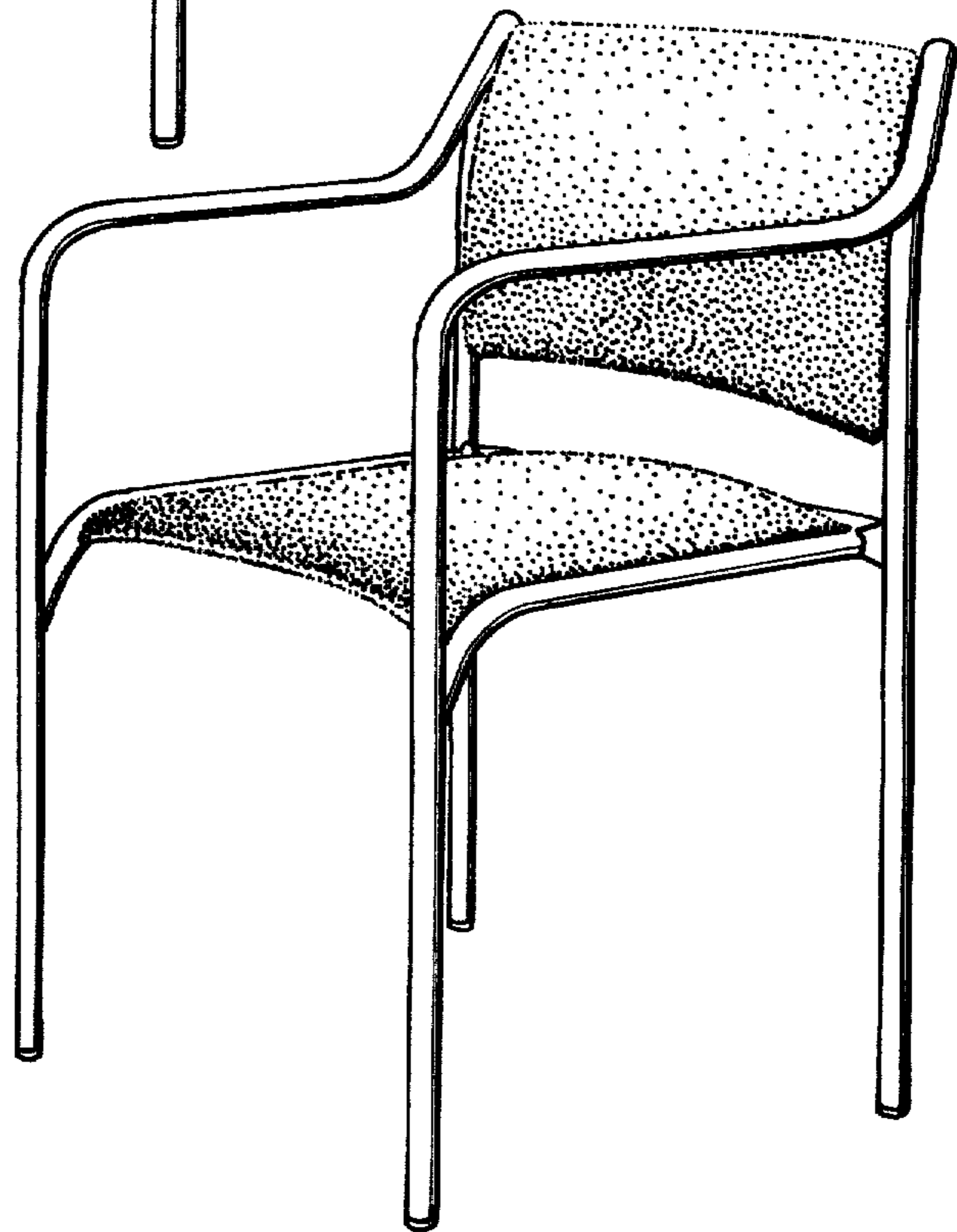

FIG. 4

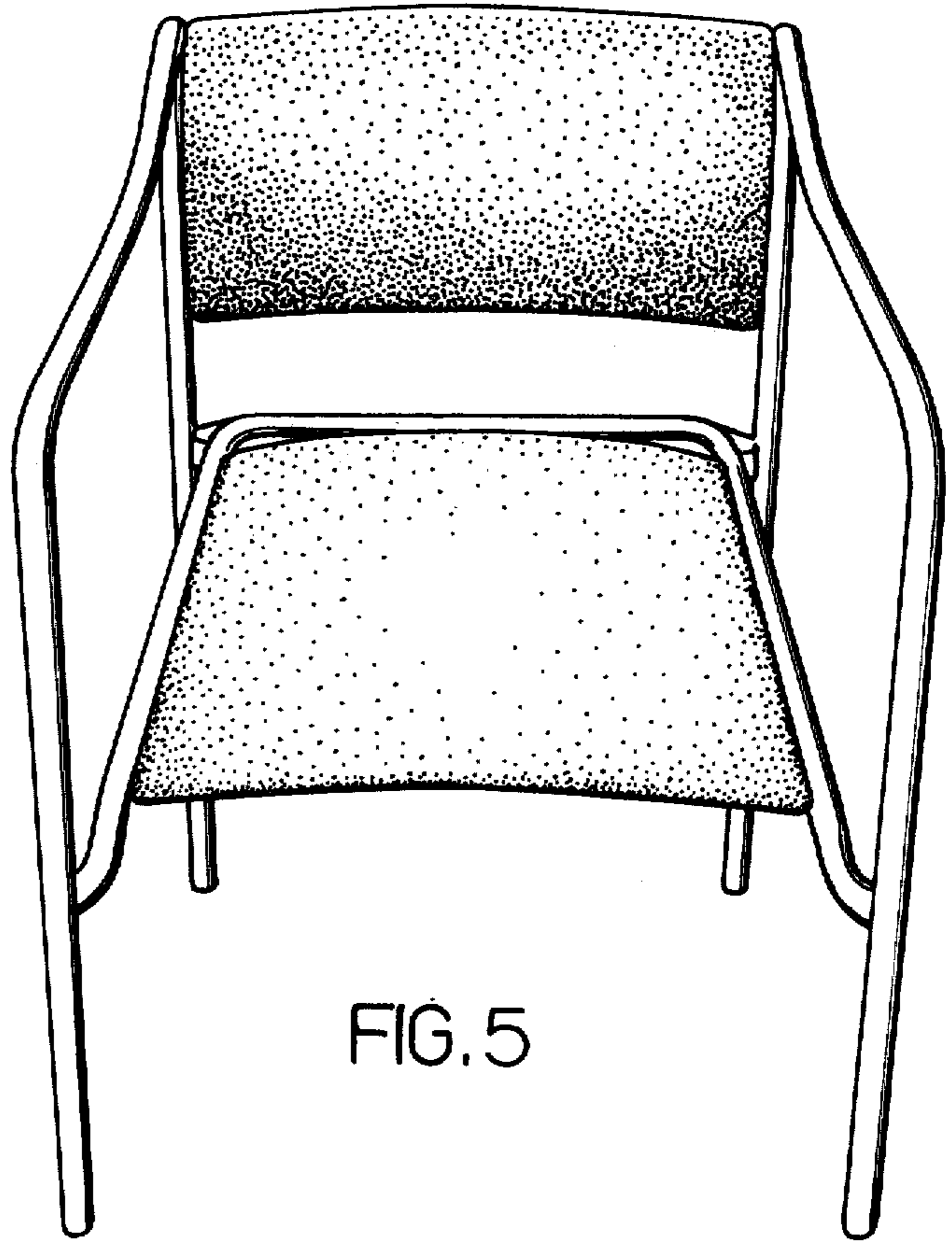

FIG. 5

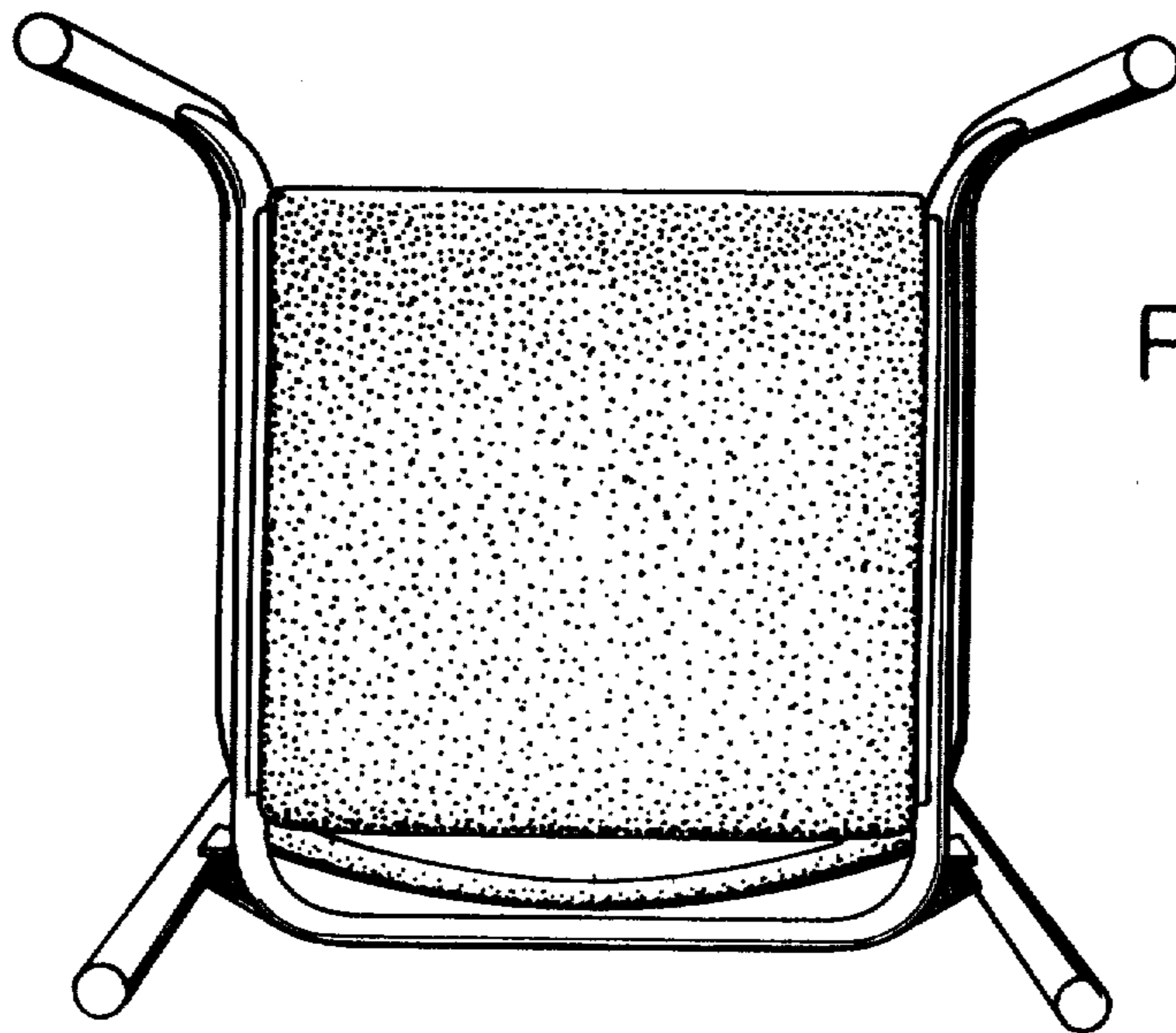

FIG. 6

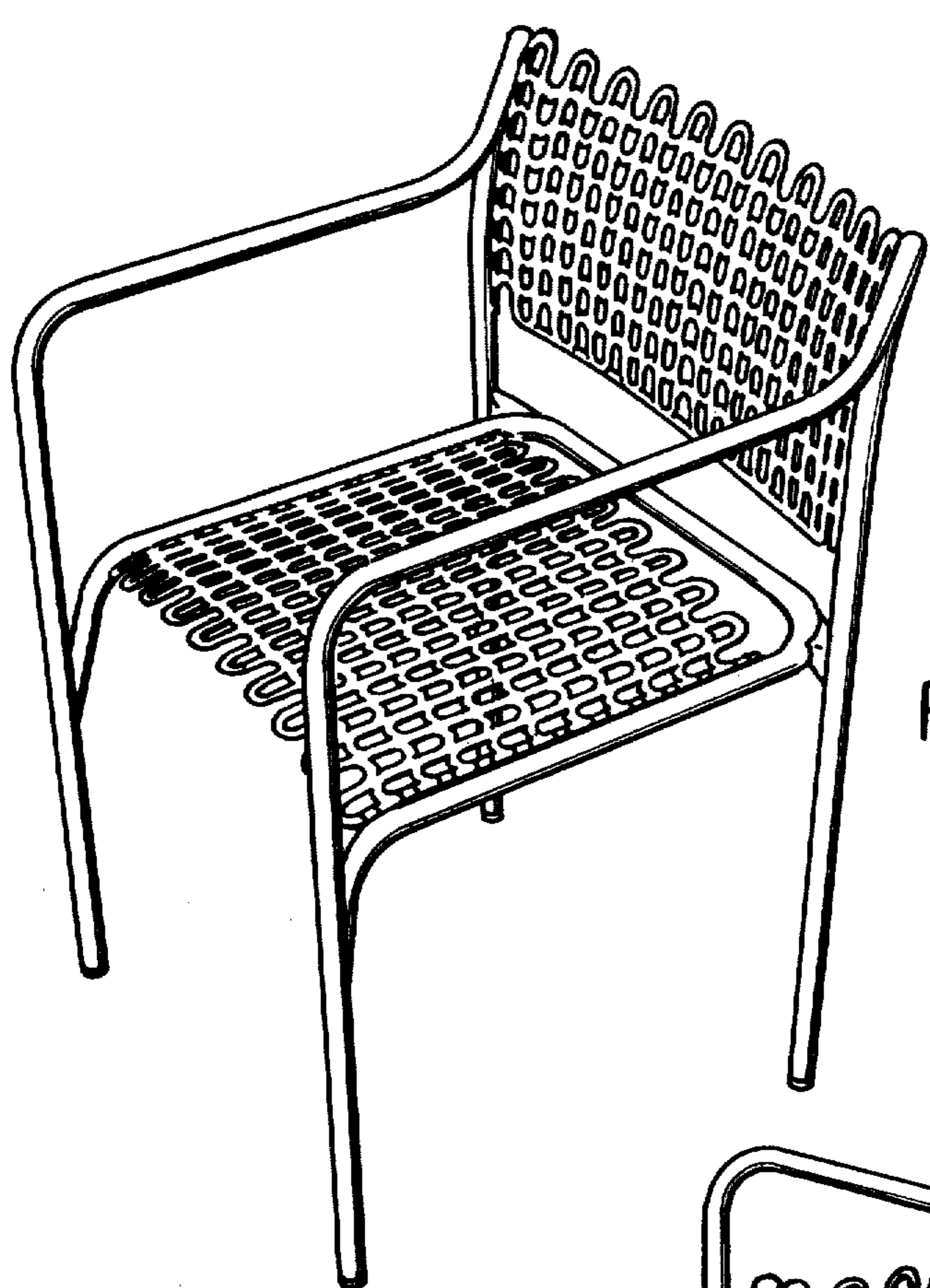

FIG. 7

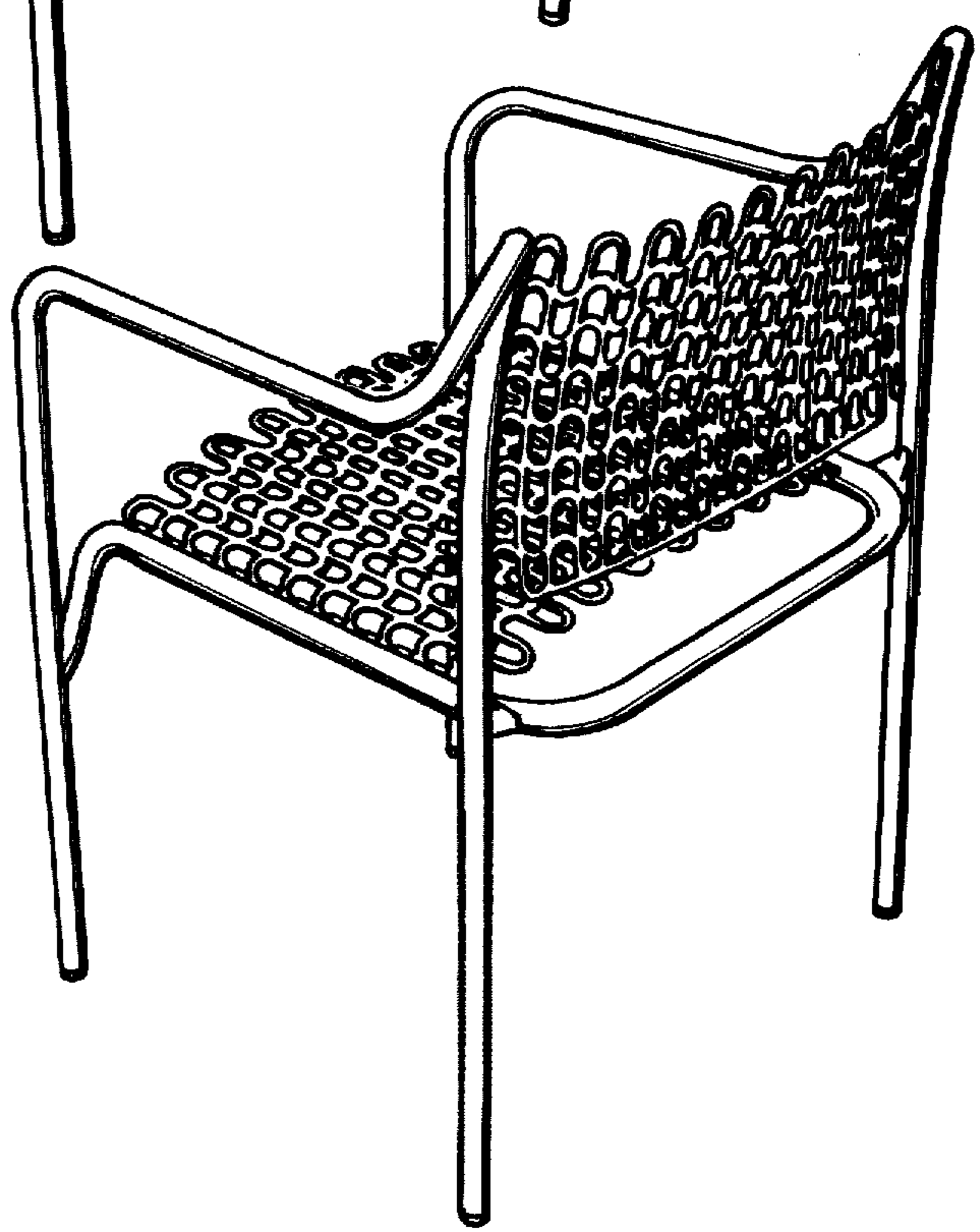

FIG. 8