

[54] **BUILDING STRUCTURE**

[75] Inventors: **William S. Denton, Jr.,** Morristown;
Donald P. Shell, Knoxville; **Hubert**
Bebb, Gatlinburg, all of Tenn.

[73] Assignee: **Comunity Tectonics, Inc.,** Knoxville,
Tenn.

[**] Term: **14 Years**

[21] Appl. No.: **295,714**

[22] Filed: **Aug. 24, 1981**

[51] Int. Cl. **D25—03**

[52] U.S. Cl. **D25/6**

[58] Field of Search **D25/1, 6; 52/73, 82,**
52/194, 234, 236.3

[56] **References Cited**

U.S. PATENT DOCUMENTS

D. 209,578 12/1967 Rodin D25/6
4,327,531 5/1982 Cazaly et al. 52/73

OTHER PUBLICATIONS

Progressive Architecture, May 1978, p. 27, Reunion
Tower Illustrations at top left and center of page.

Primary Examiner—A. Hugo Word
Attorney, Agent, or Firm—Pitts, Ruderman & Kesterson

[57] **CLAIM**

The ornamental design for a building structure, as
shown.

DESCRIPTION

FIG. 1 is a front elevation view of a building structure.
FIG. 2 is a right side elevation view.
FIG. 3 is a rear elevation view.
FIG. 4 is a left side elevation view.
FIG. 5 is a top elevation view.
FIG. 6 is a bottom elevation view.

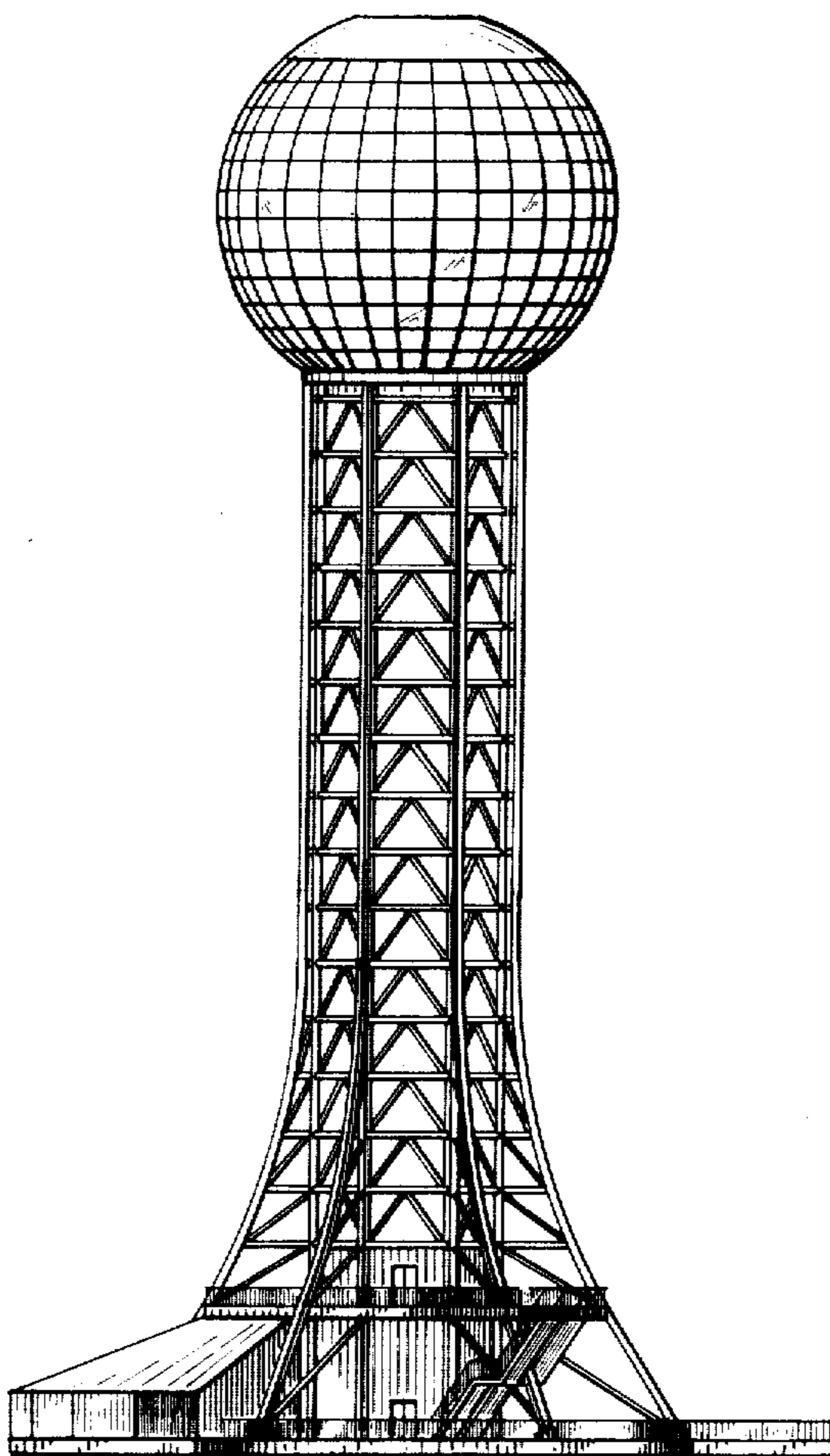
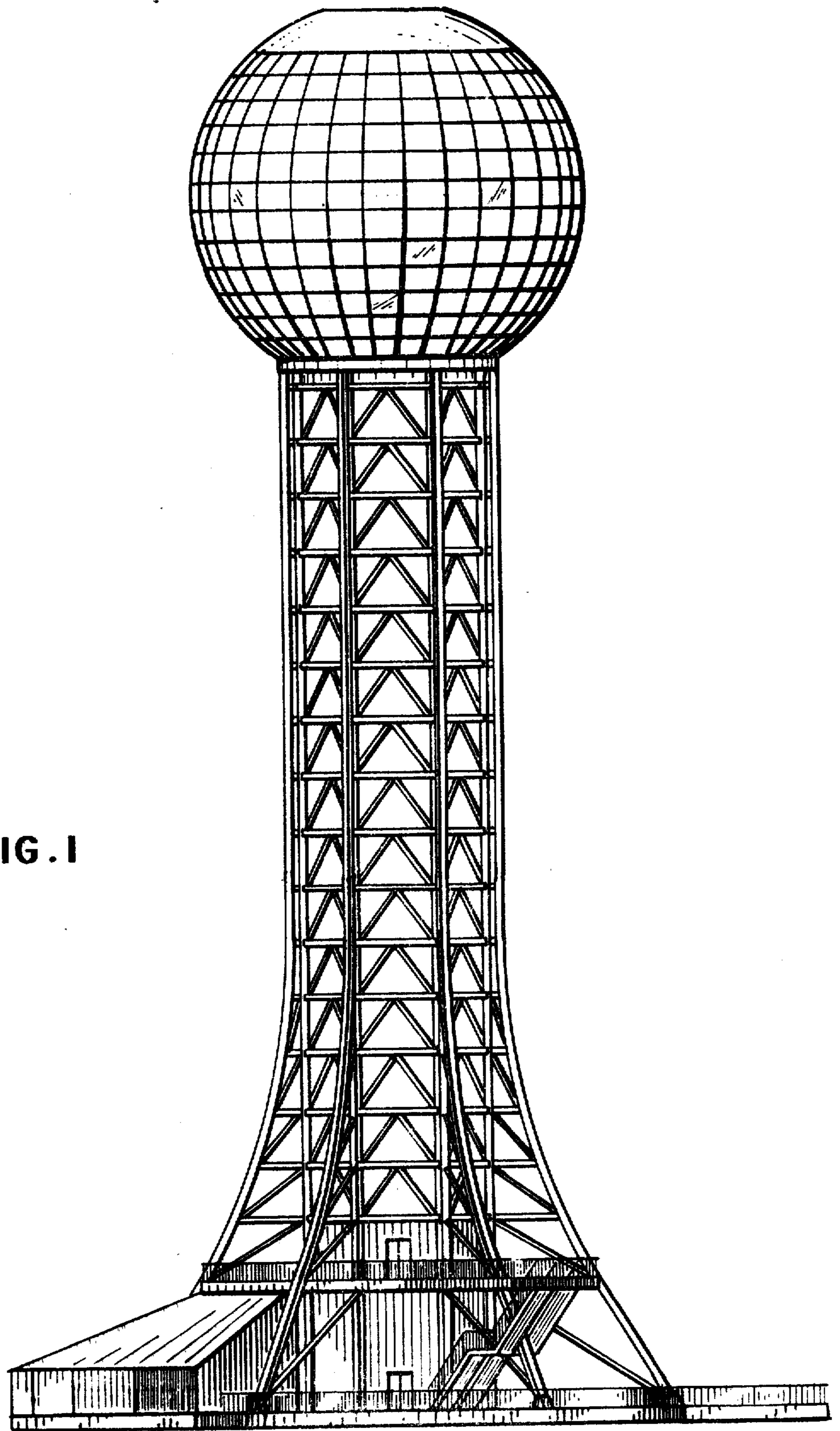

FIG. 1



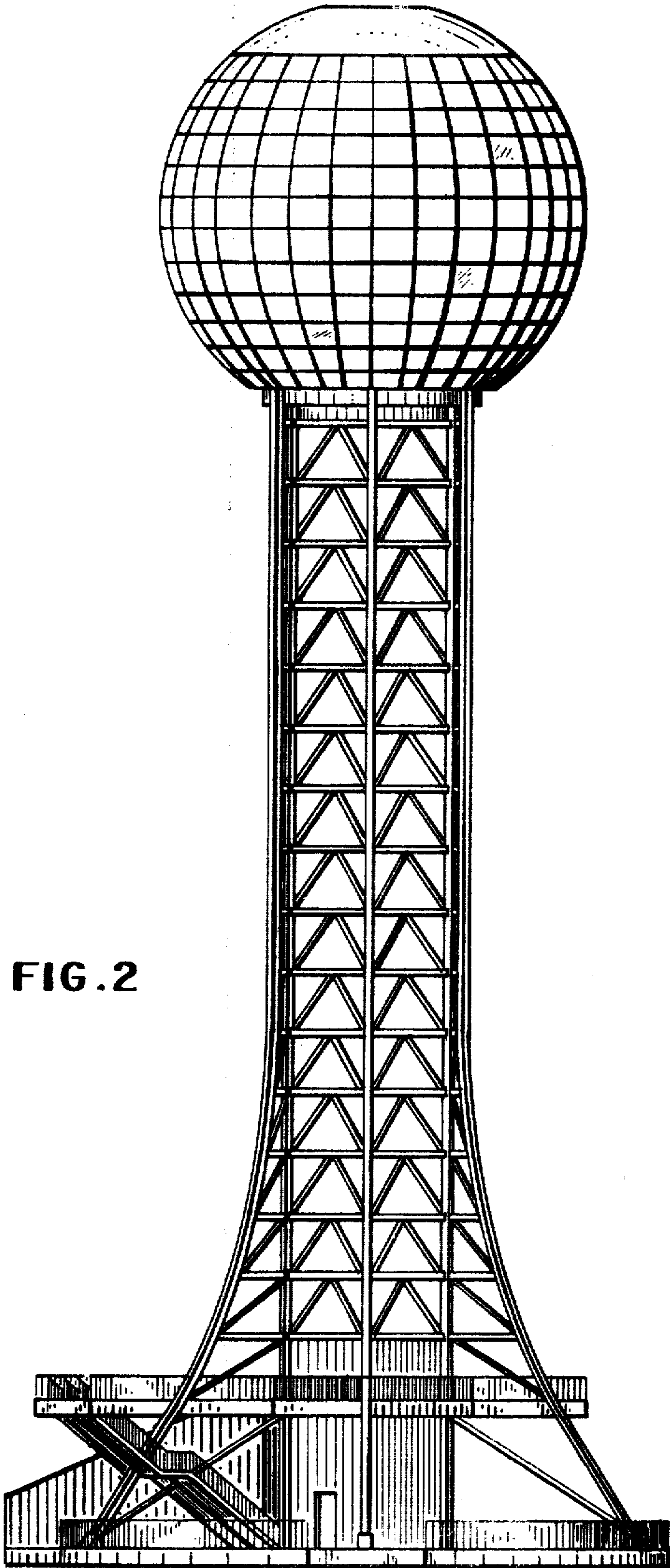

FIG. 2

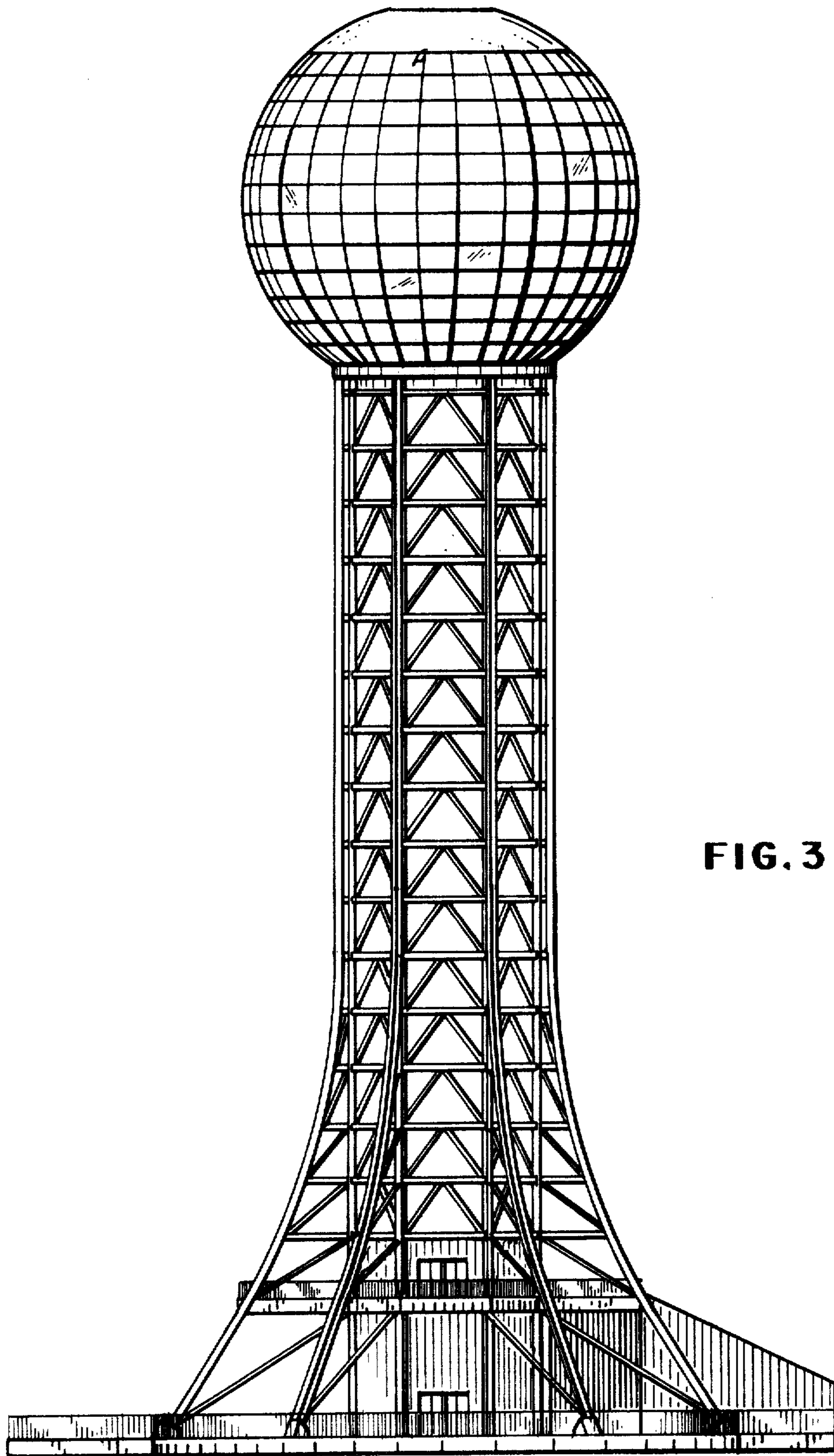

FIG. 3

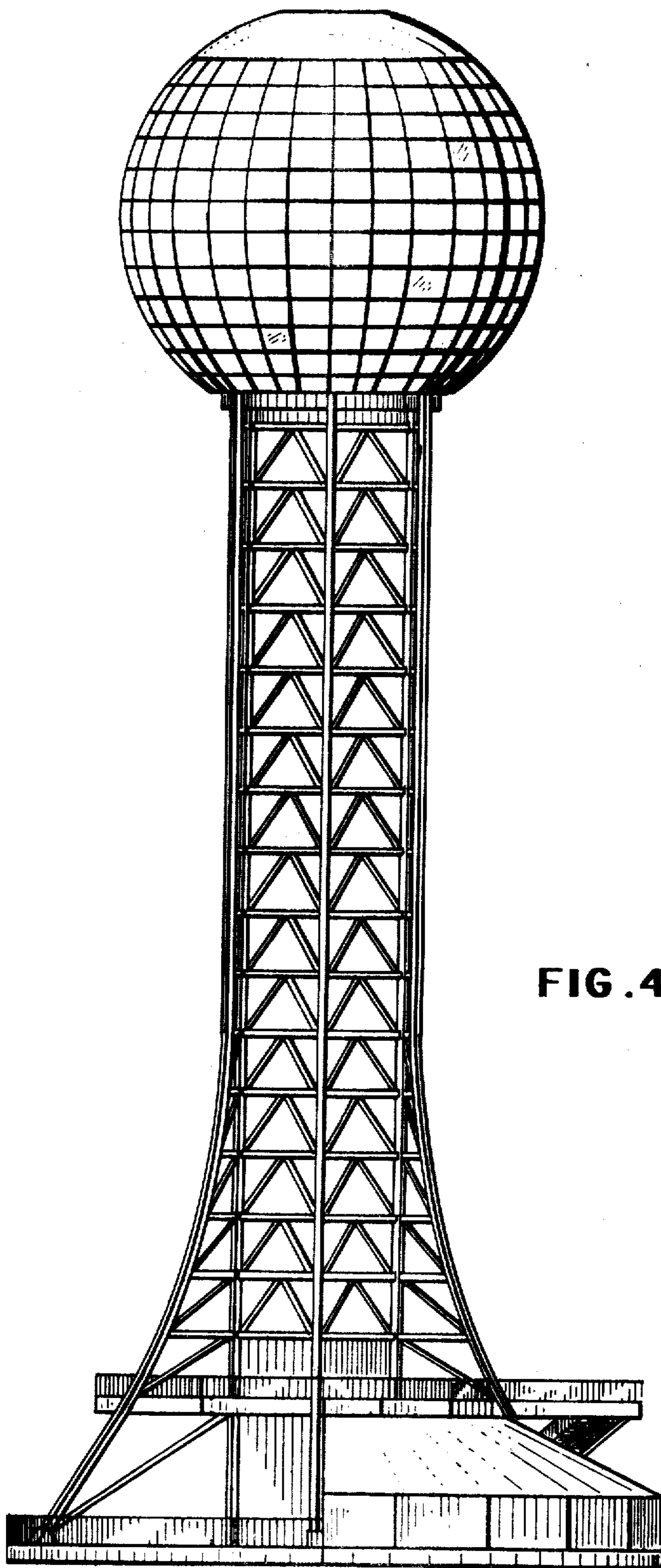

FIG. 4

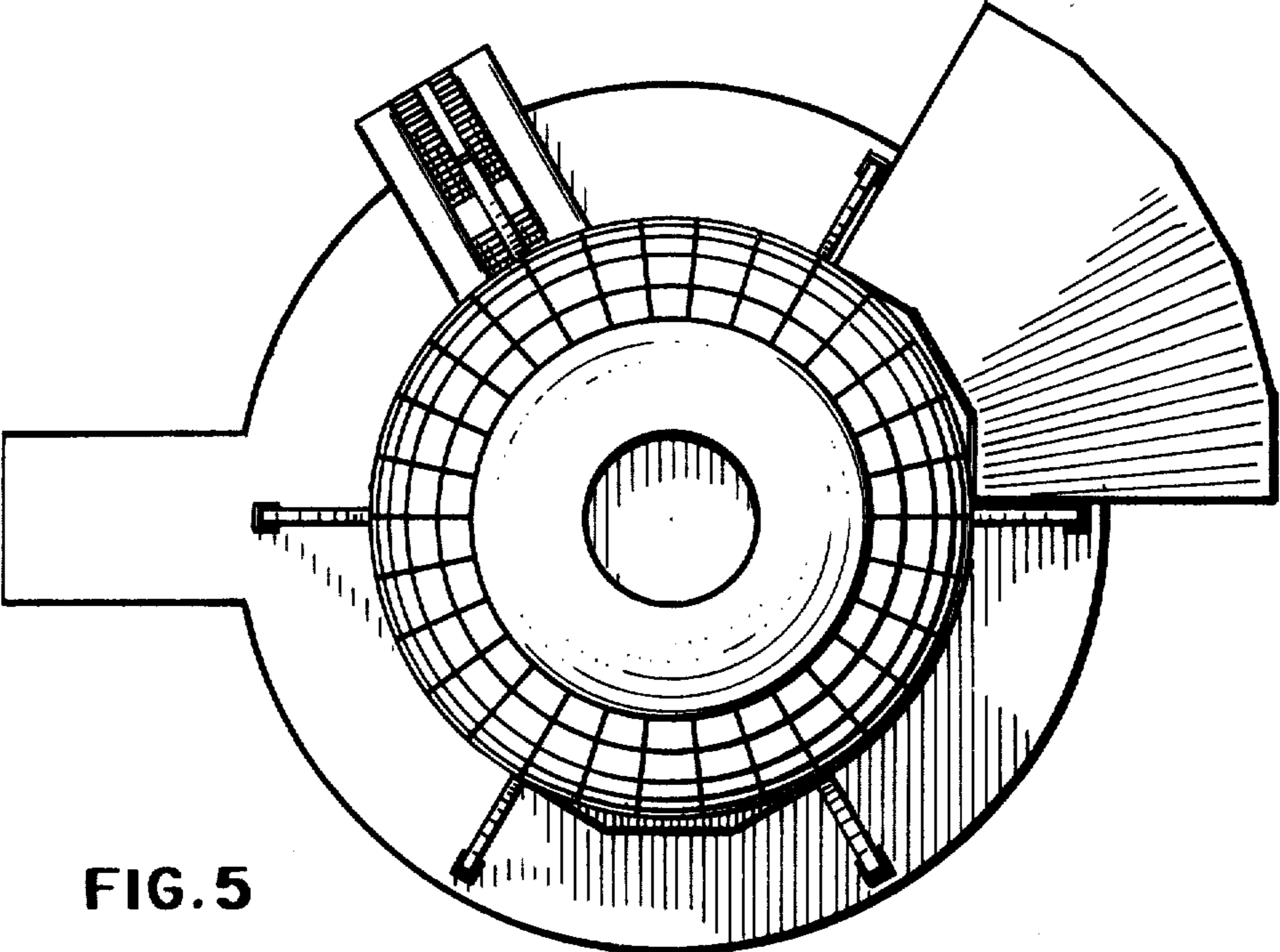

FIG. 5

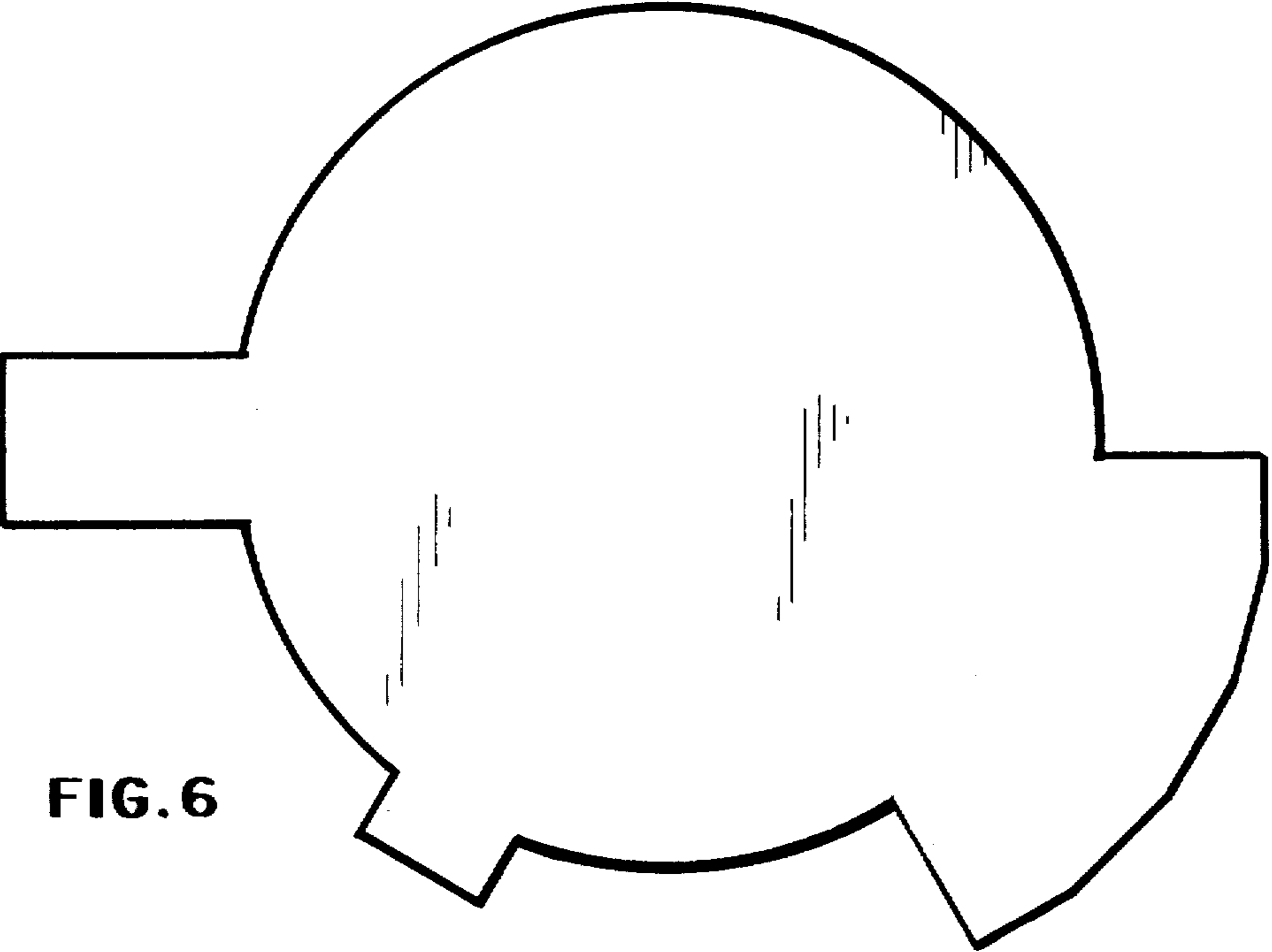

FIG. 6