

[54] COMBINED CEILING FAN AND LIGHT

[75] Inventor: Lawrence G. McCain, Beverly Hills, Calif.

[73] Assignee: Allware Agencies Limited, London, England

[**] Term: 14 Years

[21] Appl. No.: 178,021

[22] Filed: Aug. 14, 1980

[51] Int. Cl. B23-04

[52] U.S. Cl. D23/158

[58] Field of Search D23/139-167; D26/59; 416/58, 223 R

[56] References Cited

U.S. PATENT DOCUMENTS

- D. 82,179 9/1930 Ringwald D23/158
- 636,871 11/1899 Wait 416/5
- 2,119,398 5/1938 Morse 416/5

OTHER PUBLICATIONS

- Home Lighting & Accessories, Mar. 1977, p. 34, bottom left item.
- Home Lighting & Accessories, Nov. 1978, p. 40, top left item.

Mistral Sales Brochure, Mistral Sunray Company.
Casablanca Sales Brochure, Emmerson Electric Company.
Sanyo Electric Inc. Sales Brochure.

Primary Examiner—James R. Largen
Attorney, Agent, or Firm—Fitch, Even, Tabin & Flannery

[57] CLAIM

The ornamental design for a combined ceiling fan and light, substantially as shown and described.

DESCRIPTION

FIG. 1 is a perspective view of a combined ceiling fan and light showing my new design;
 FIG. 2 is a top plan view thereof;
 FIG. 3 is a bottom view thereof;
 FIG. 4 is a side elevation view thereof;
 FIG. 5 is a perspective view of a modified form of the combined ceiling fan and light shown in FIG. 1;
 FIG. 6 is a side elevational view of FIG. 5;
 FIG. 7 is a perspective view of a second modified form of the combined ceiling fan and light shown in FIG. 1; and
 FIG. 8 is a side elevational view of FIG. 7.
 The blades of the ceiling fan have been broken away in FIGS. 2, 3, 5 and 7 for convenience of illustration.

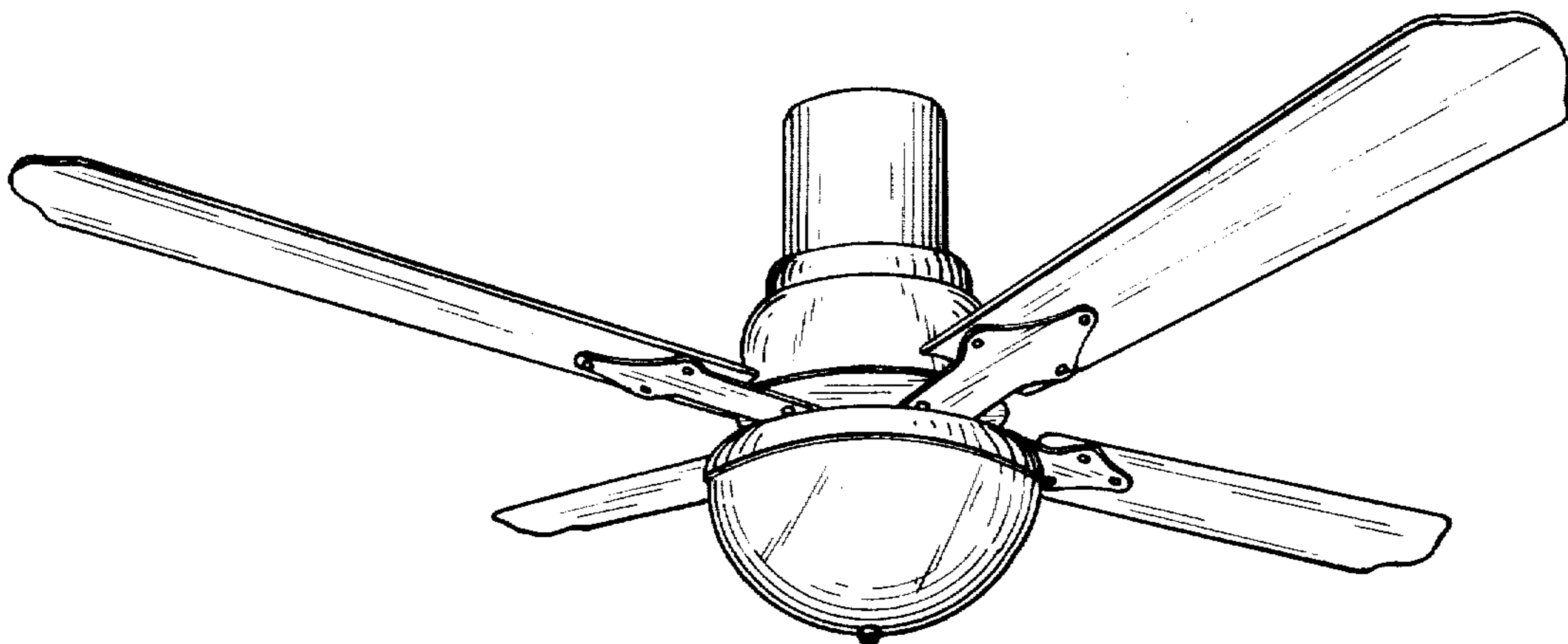

Fig. 1.

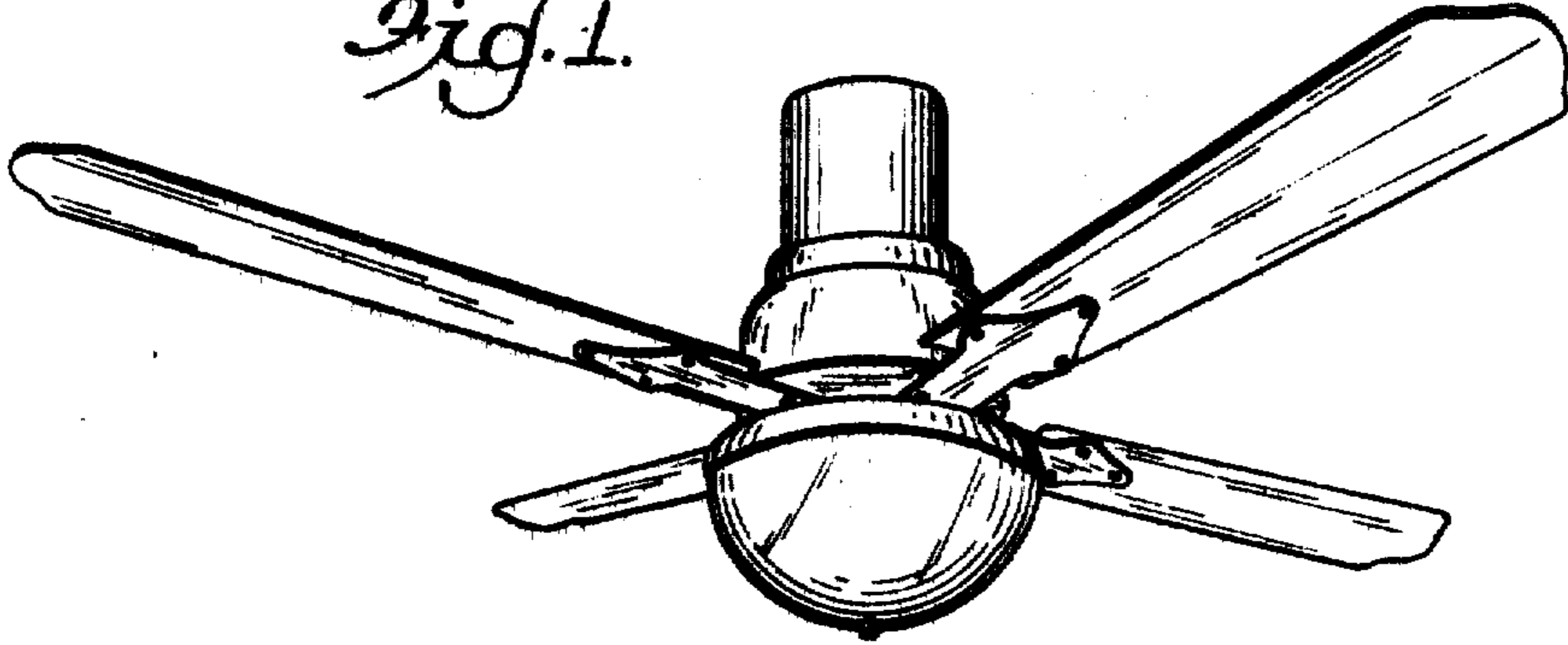

Fig. 2.

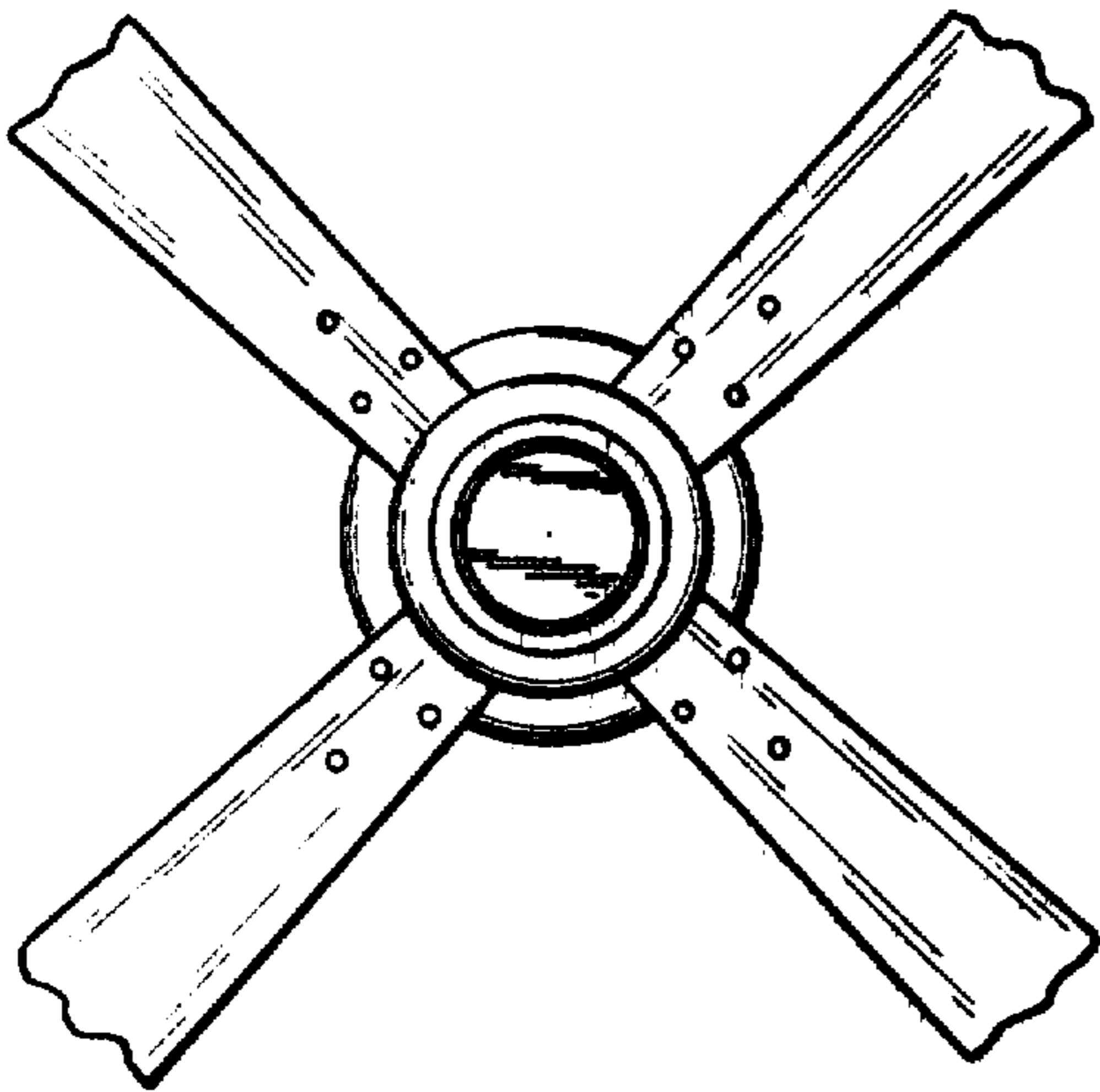

Fig. 3.

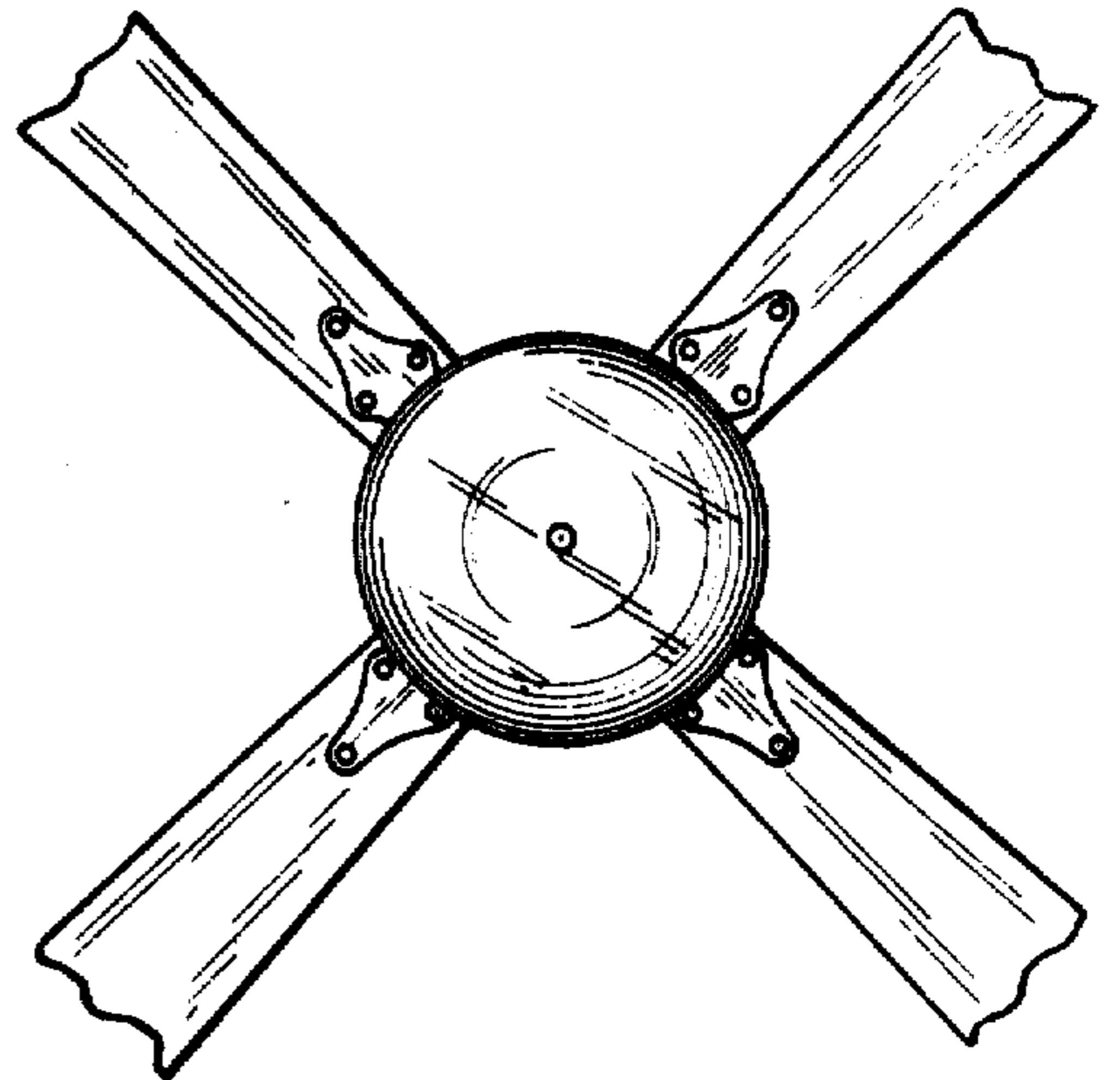

Fig. 4.

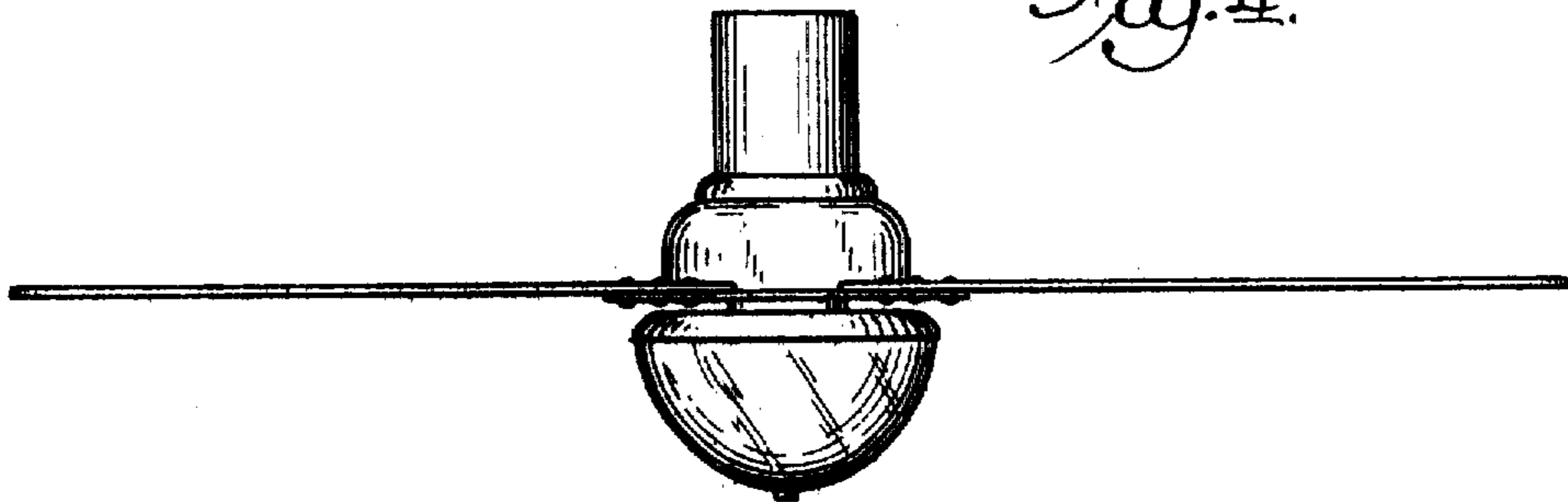

Fig. 5.

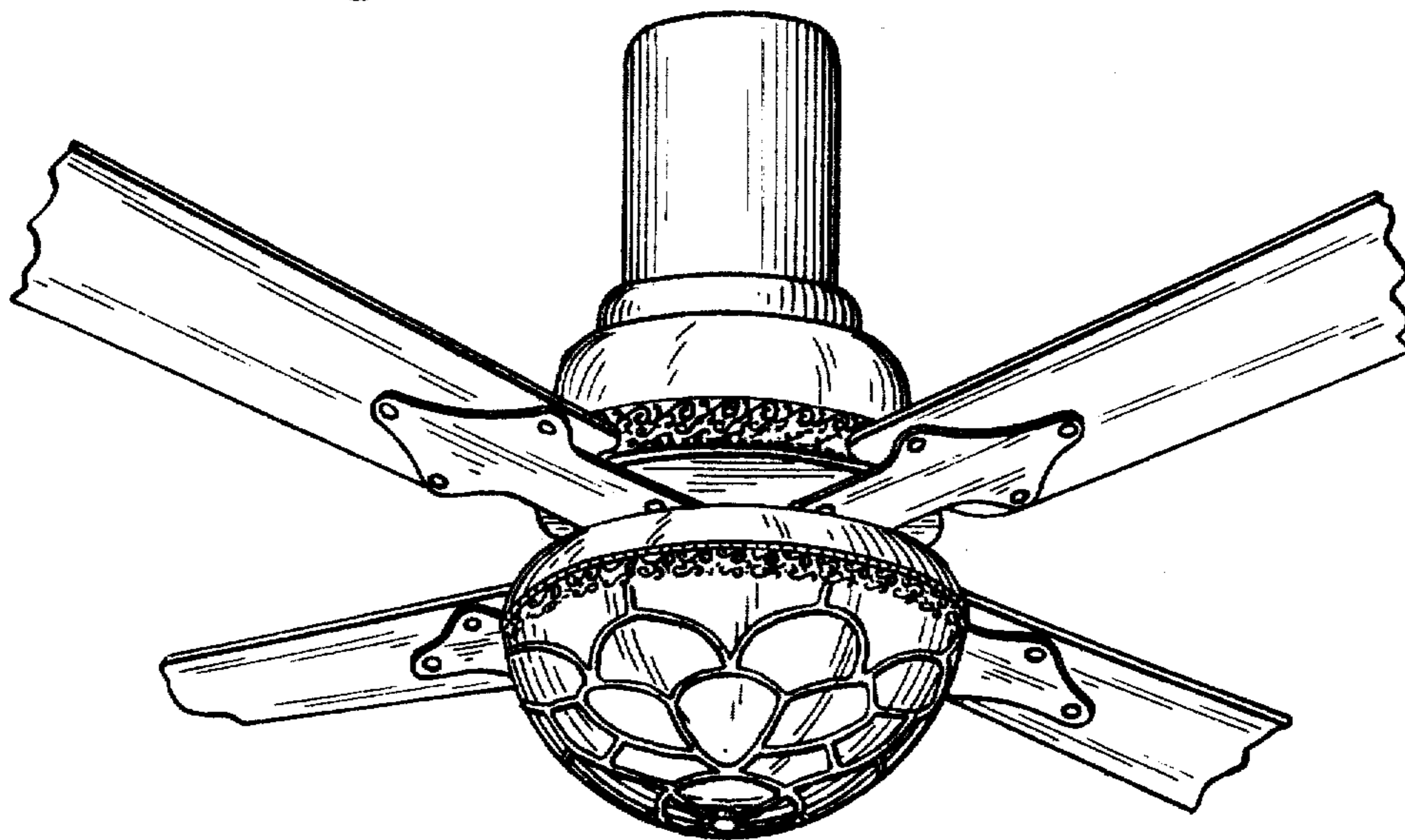

Fig. 7.

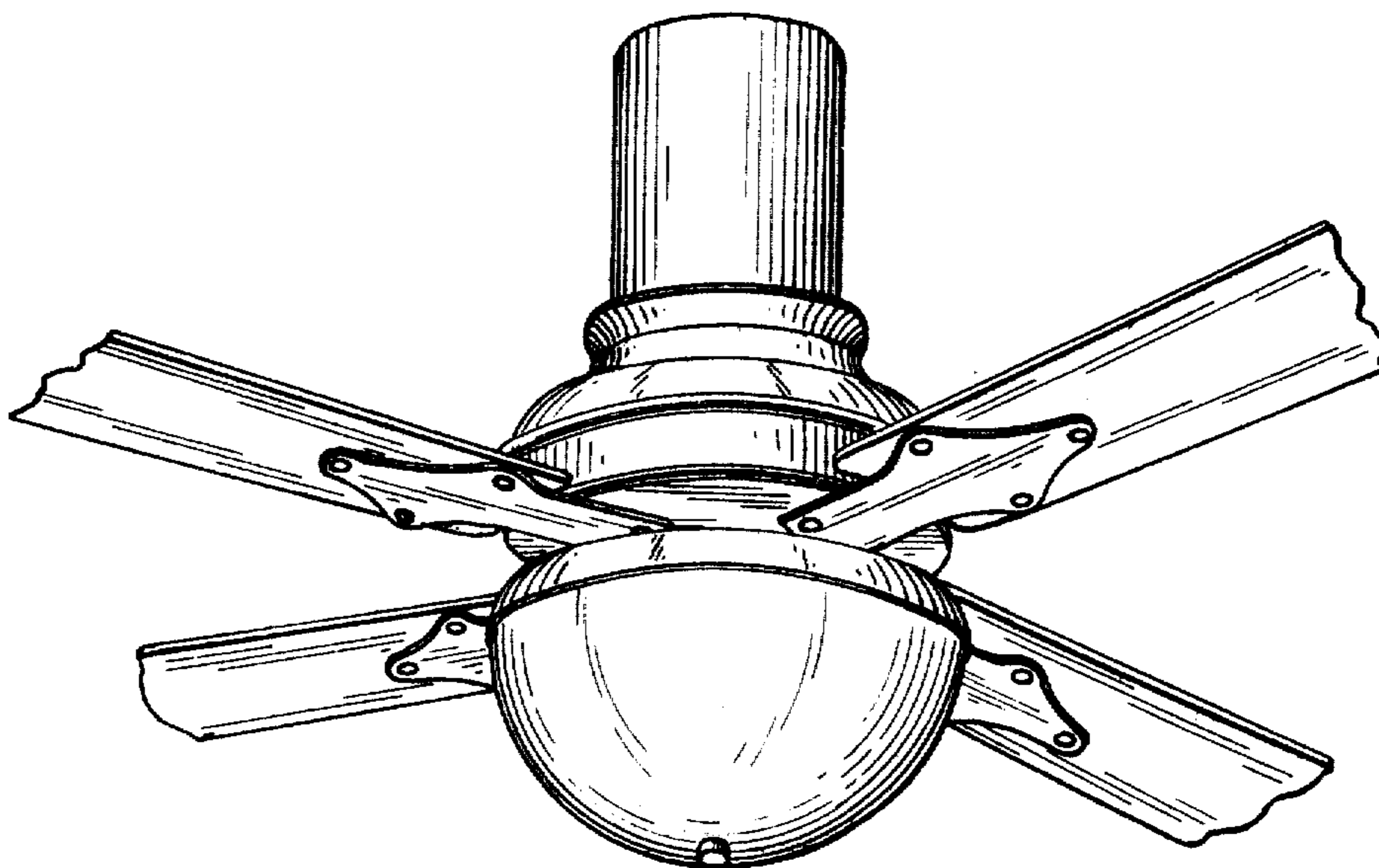

Fig. 6.

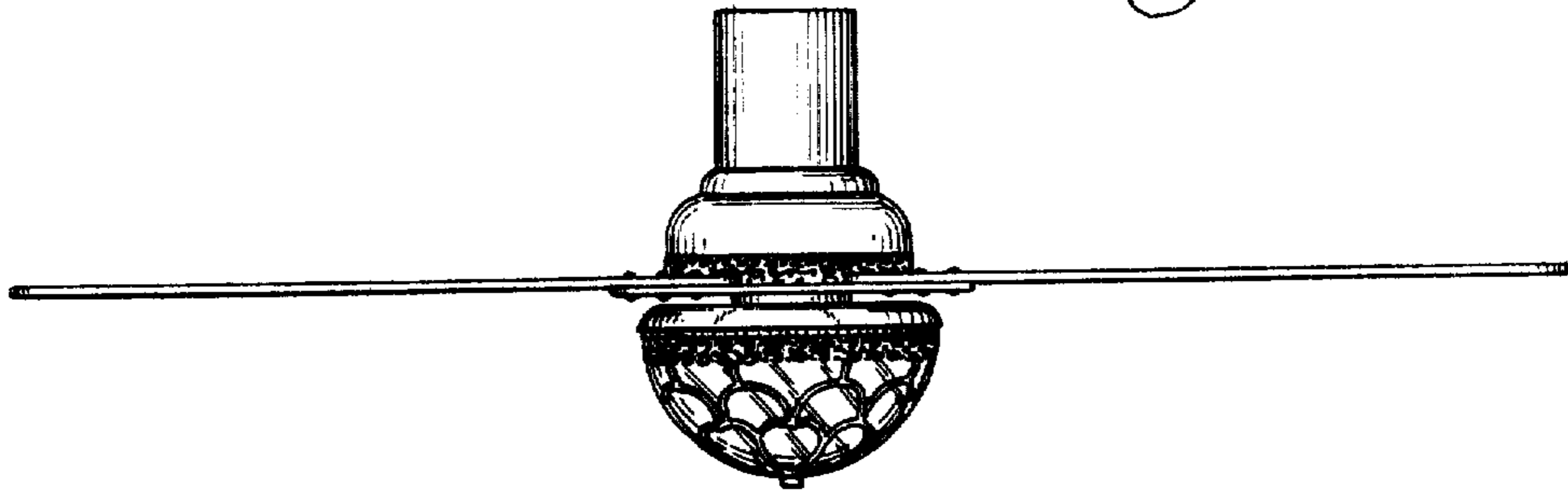

Fig. 8.

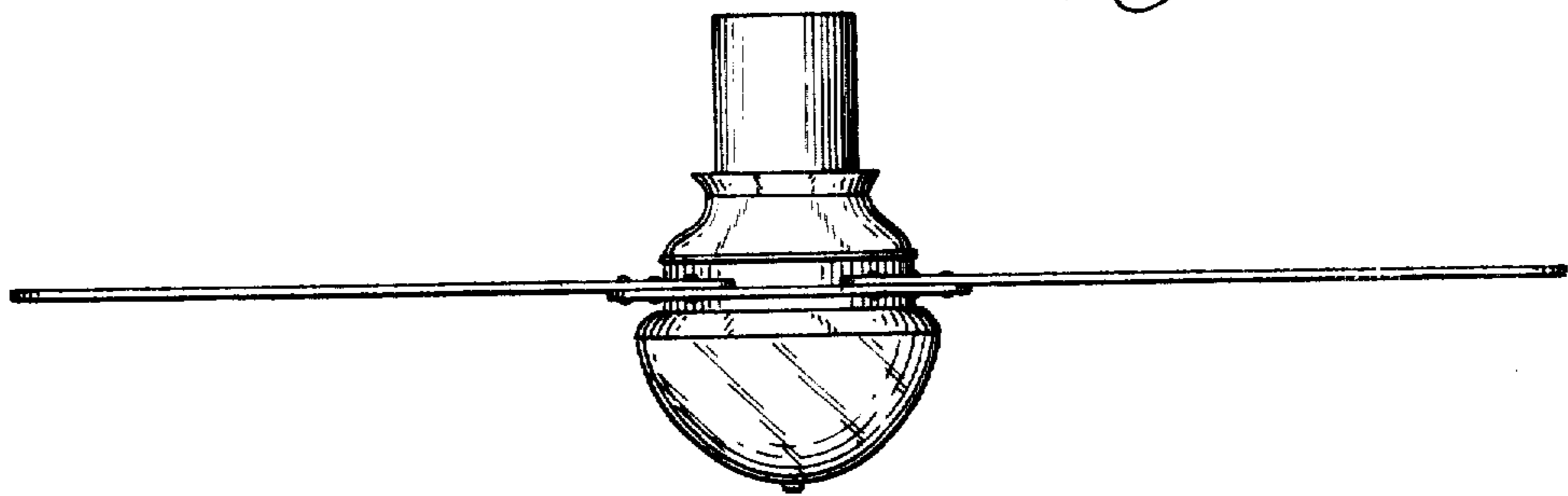

Fig. 1.

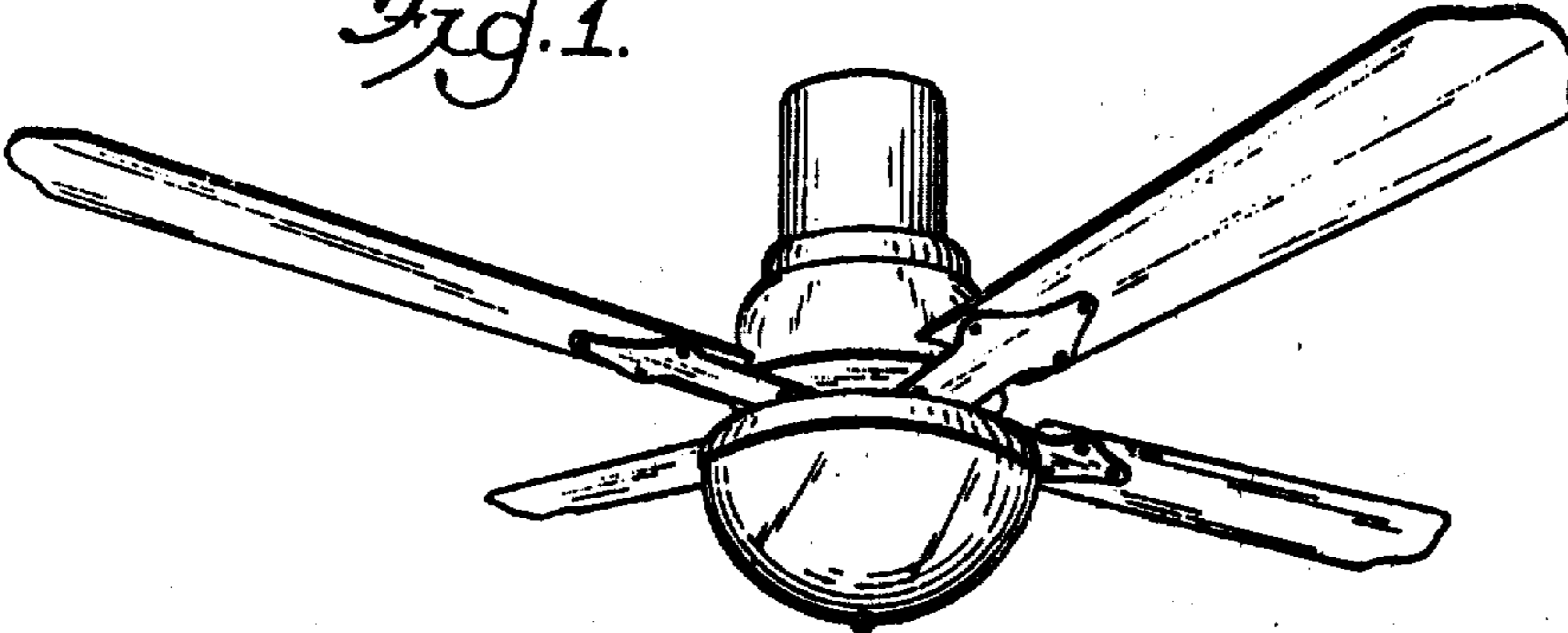

Fig. 2

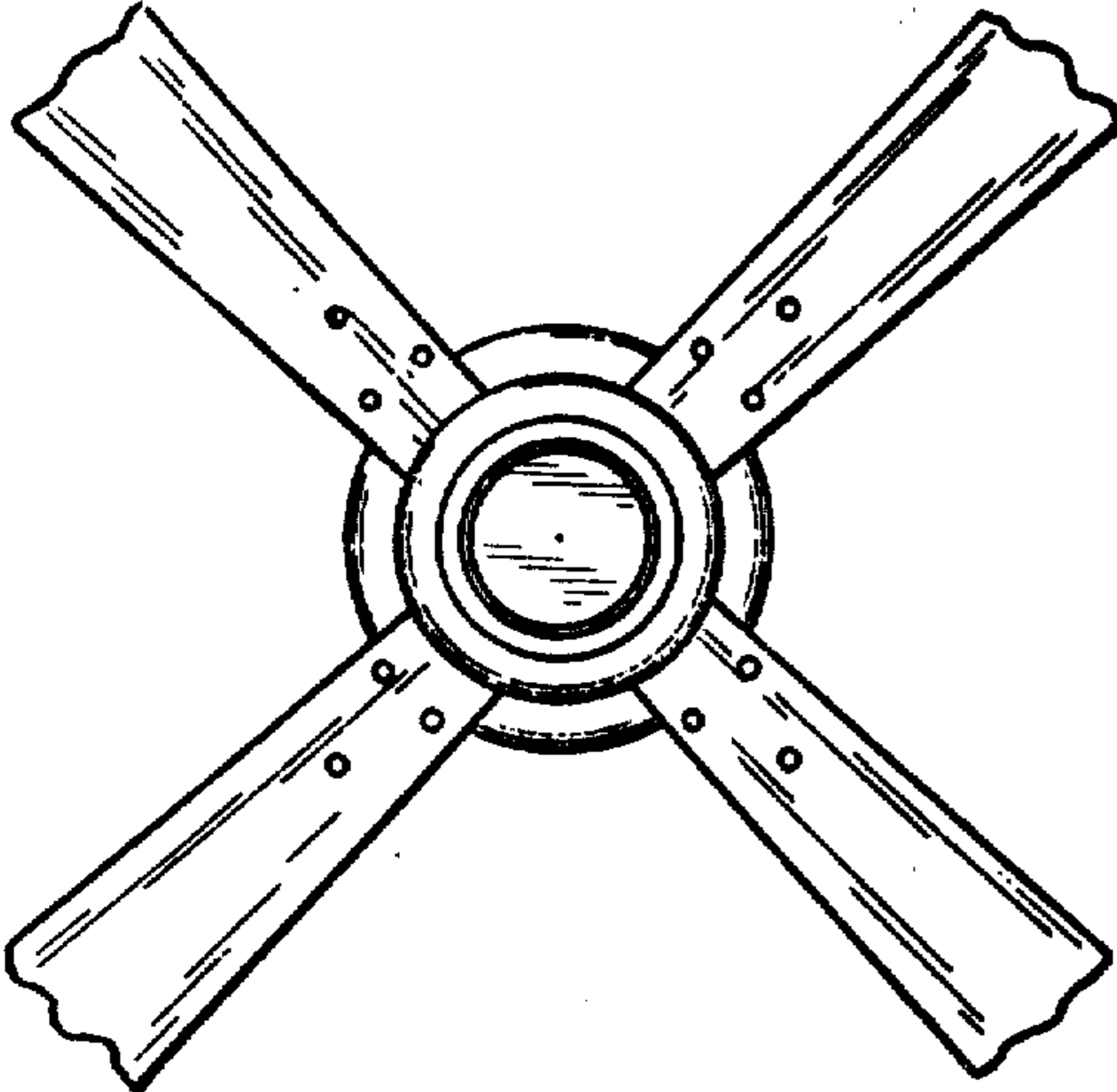

Fig. 3.

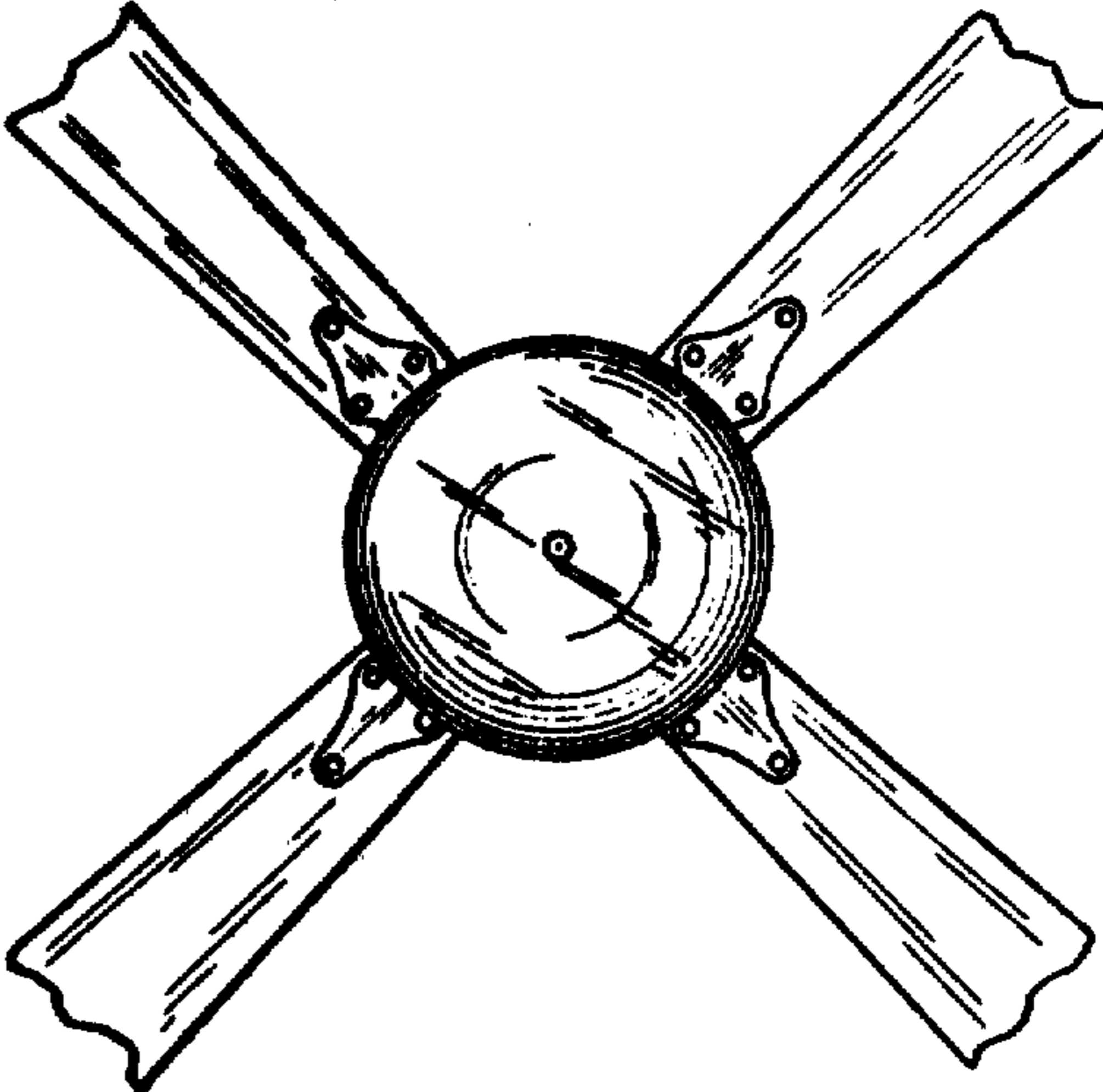

Fig. 4.

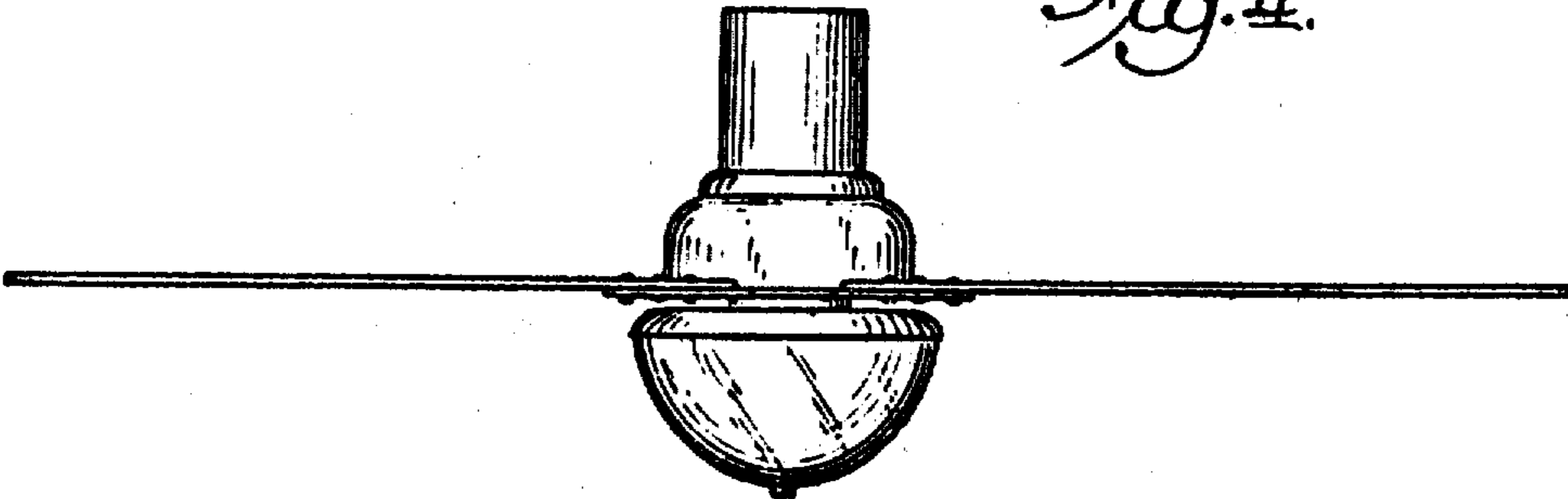

Fig. 5.

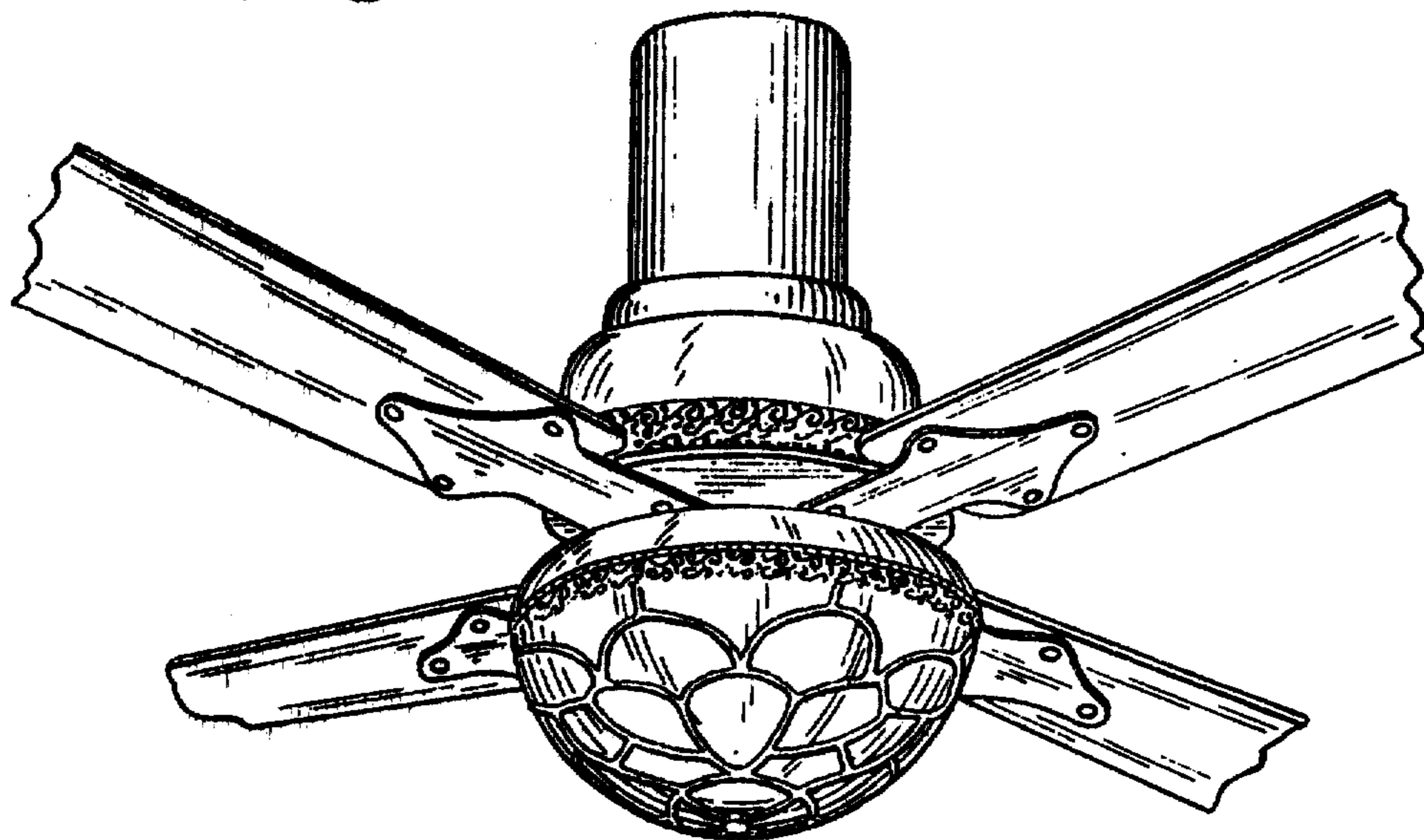

Fig. 7.

