

- [54] **POUCH FOR CARRYING JEWELRY OR SIMILAR ARTICLES**
- [75] Inventors: **Binns Handy, West Henrietta; David O. Chase, Skaneateles, both of N.Y.**
- [73] Assignee: **Lenox, Incorporated, Lawrenceville, N.J.**
- [**] Term: **14 Years**
- [21] Appl. No.: **267,375**
- [22] Filed: **May 26, 1981**
- [51] Int. Cl. **D3—02**
- [52] U.S. Cl. **D3/75; D3/30.1**
- [58] Field of Search **D3/30.1, 39, 66, 41, D3/42, 74, 75; 150/52 R, 52 C, 52 B; 229/22**

[56] **References Cited**

U.S. PATENT DOCUMENTS

D. 164,336	8/1951	Tornabe	D3/66
D. 216,350	12/1969	Selwyn	D3/75
D. 220,733	5/1971	Niblack	D3/75
D. 236,552	8/1975	Wagner	D3/75
3,900,060	8/1975	Shamman	150/52 R

Primary Examiner—George P. Word

Attorney, Agent, or Firm—Weinstein & Sutton

[57] **CLAIM**

The ornamental design for a pouch for carrying jewelry or similar articles, as shown and described.

DESCRIPTION

FIG. 1 is a top perspective view of a pouch for carrying jewelry or similar articles showing our new design; FIG. 2 is a bottom perspective view thereof; FIG. 3 is a rear elevational view thereof; FIG. 4 is a front elevational view thereof; FIG. 5 is a left side elevational view thereof; FIG. 6 is a right side elevational view thereof; FIG. 7 is a plan of the interior of the pouch in the unfolded condition; FIG. 8 is a plan view of the exterior of the pouch in the unfolded condition; FIG. 9 is a front edge elevational view of FIG. 8; FIG. 10 is a right edge elevational view thereof; FIG. 11 is a left edge elevational view thereof; FIG. 12 is a rear edge elevational view thereof; FIG. 13 is a plan view of a modified form of the interior of the pouch shown in FIG. 7; and FIG. 14 is a perspective view of the exterior of the modified form.

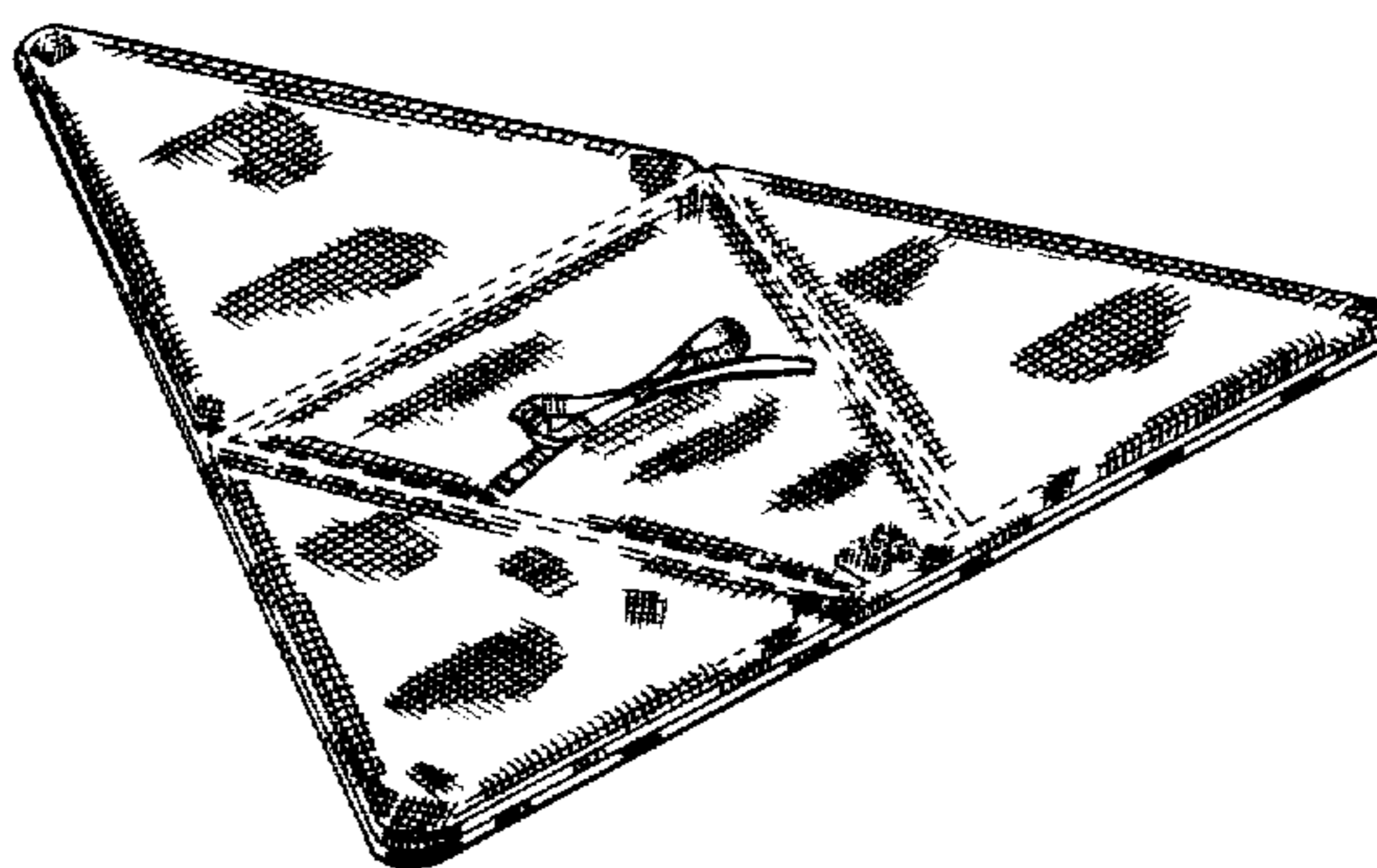
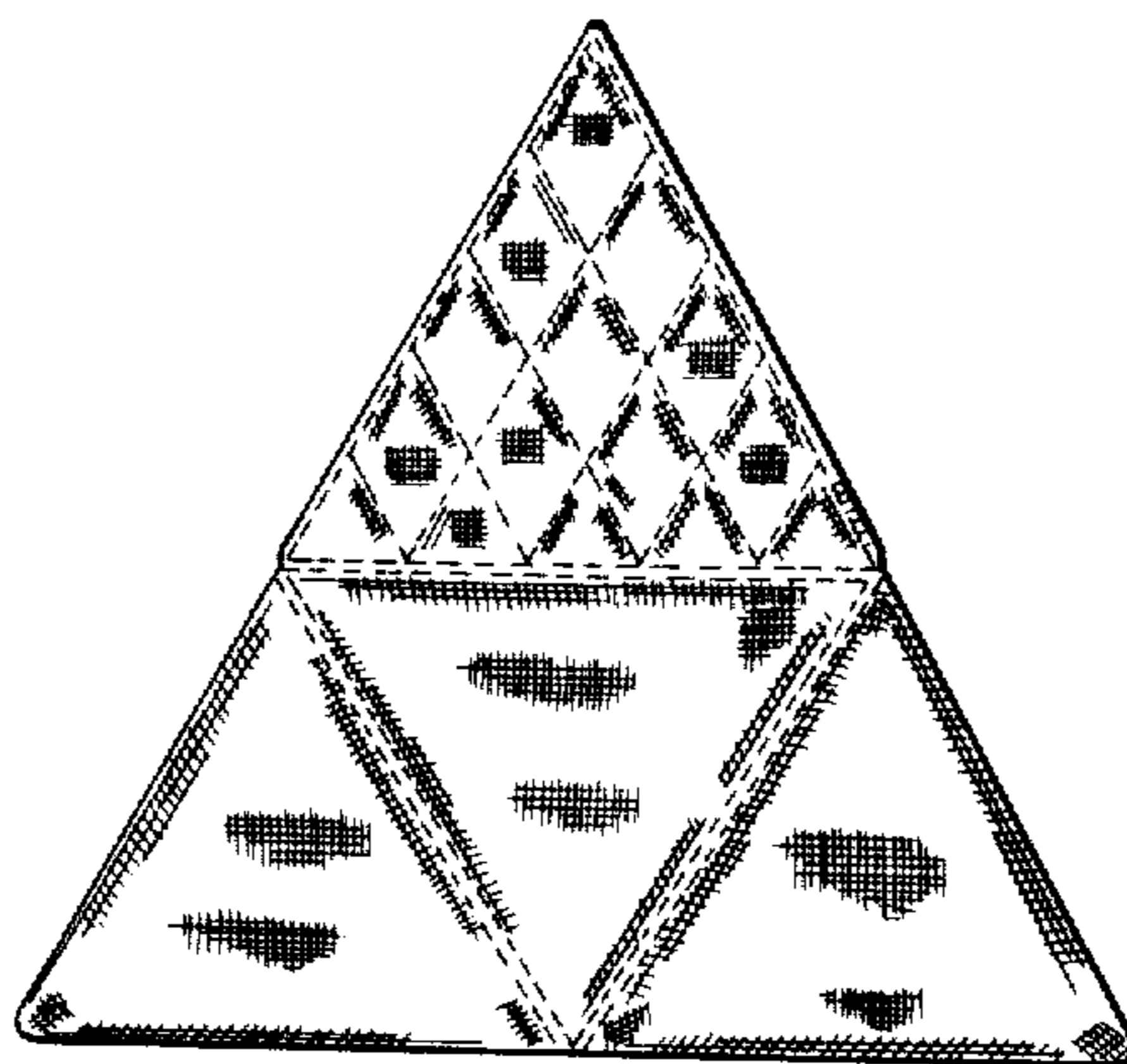

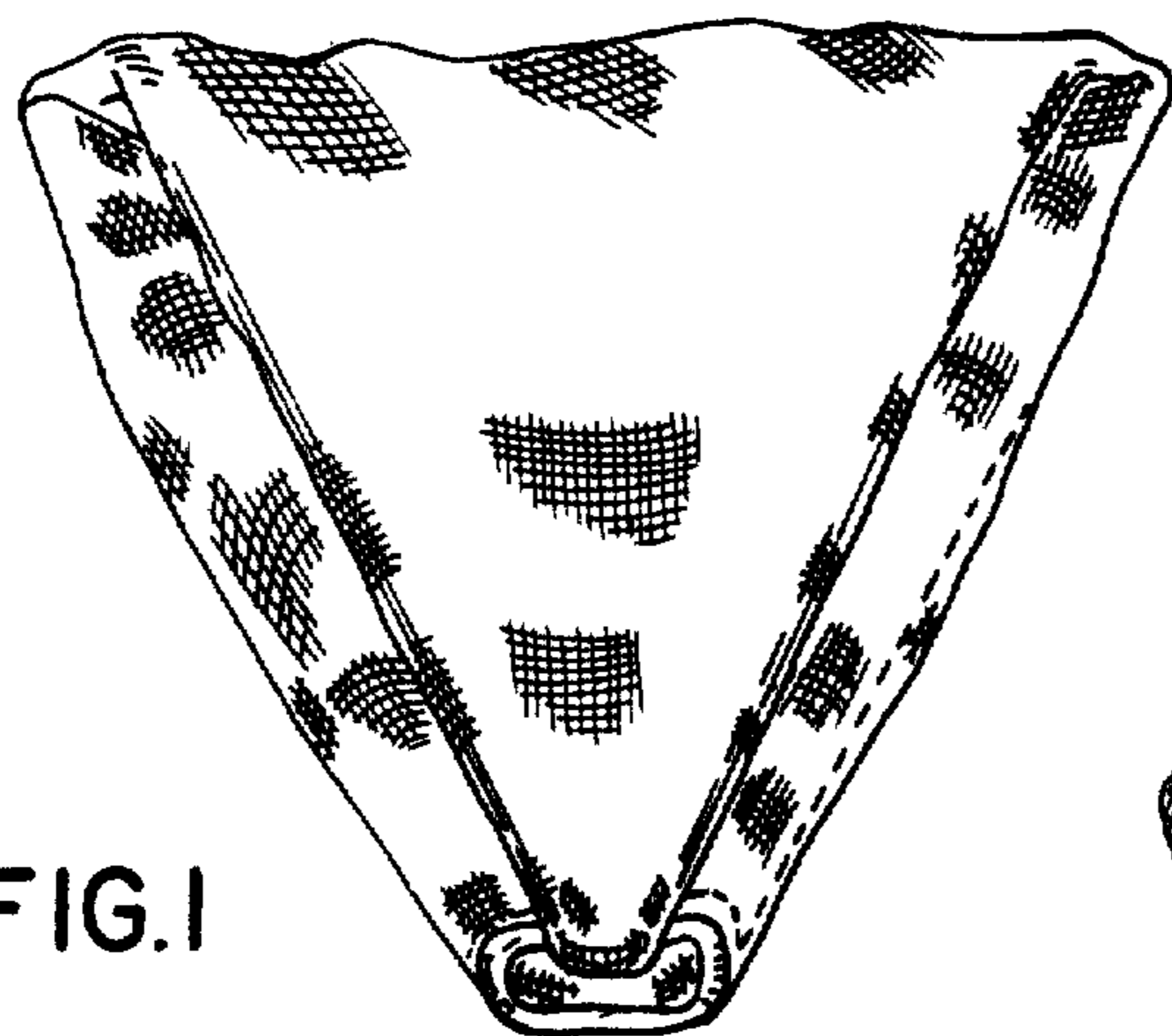

FIG. 1

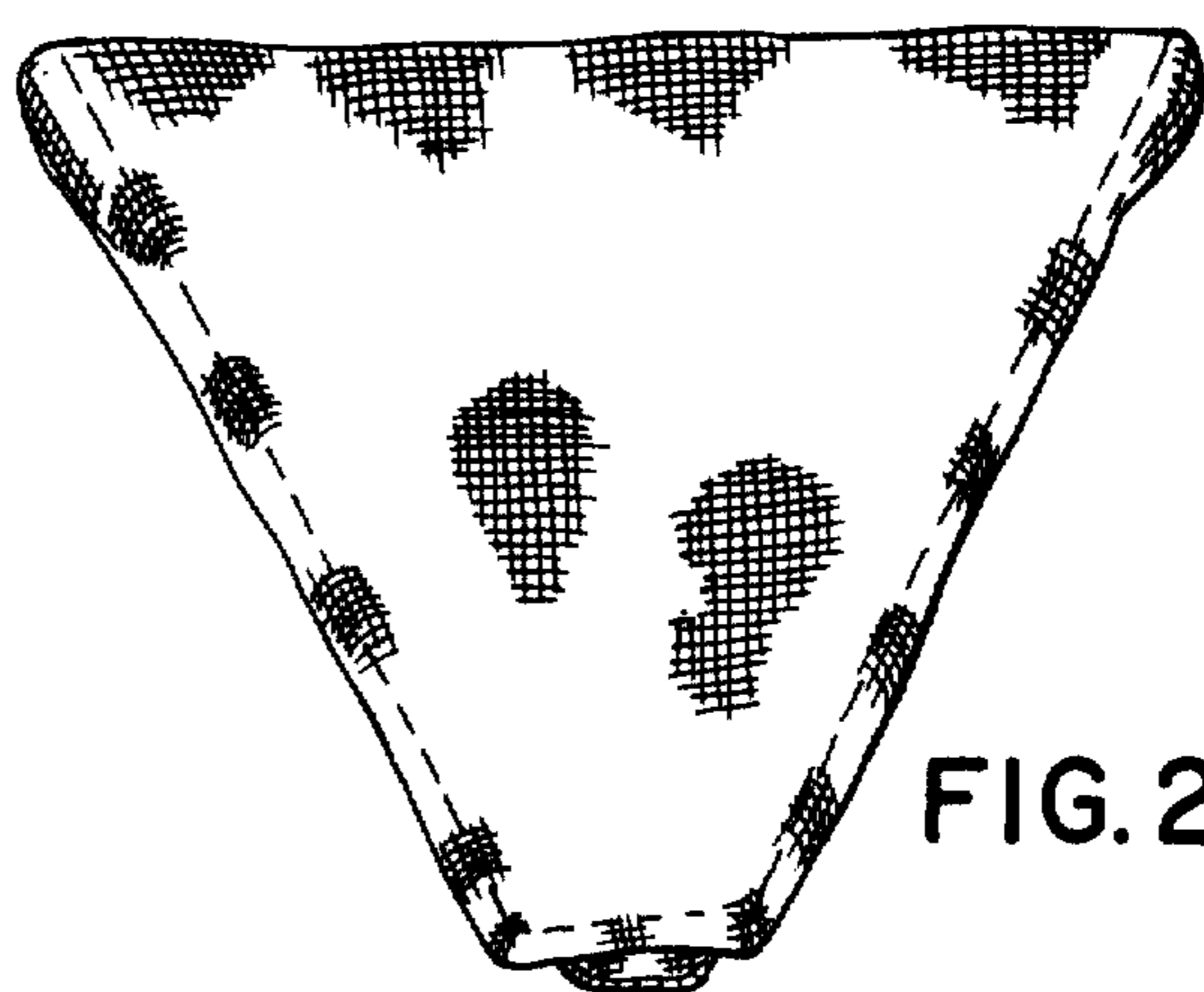

FIG. 2



FIG. 4

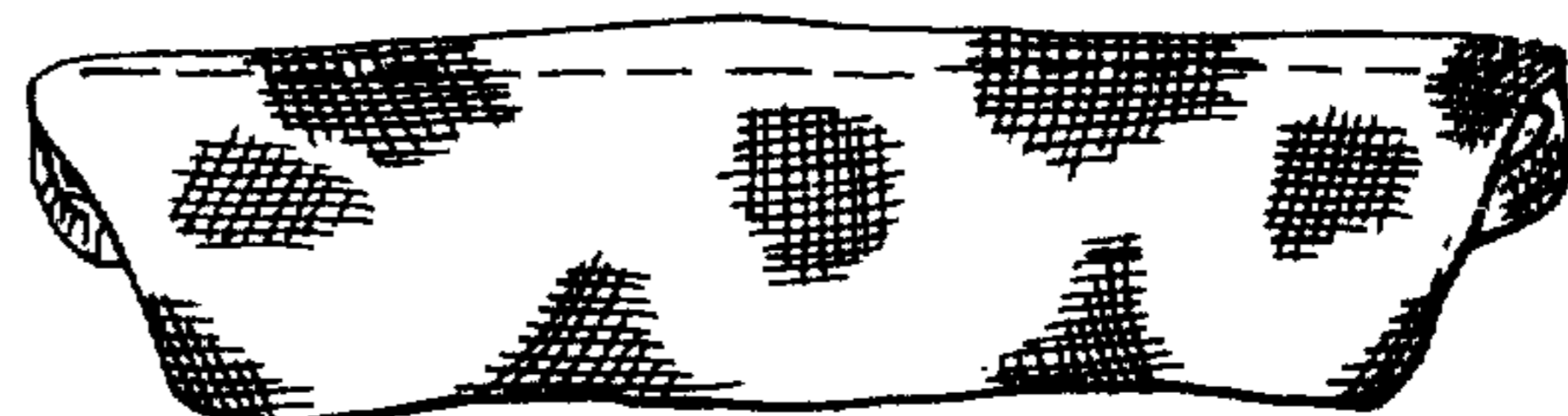

FIG. 3

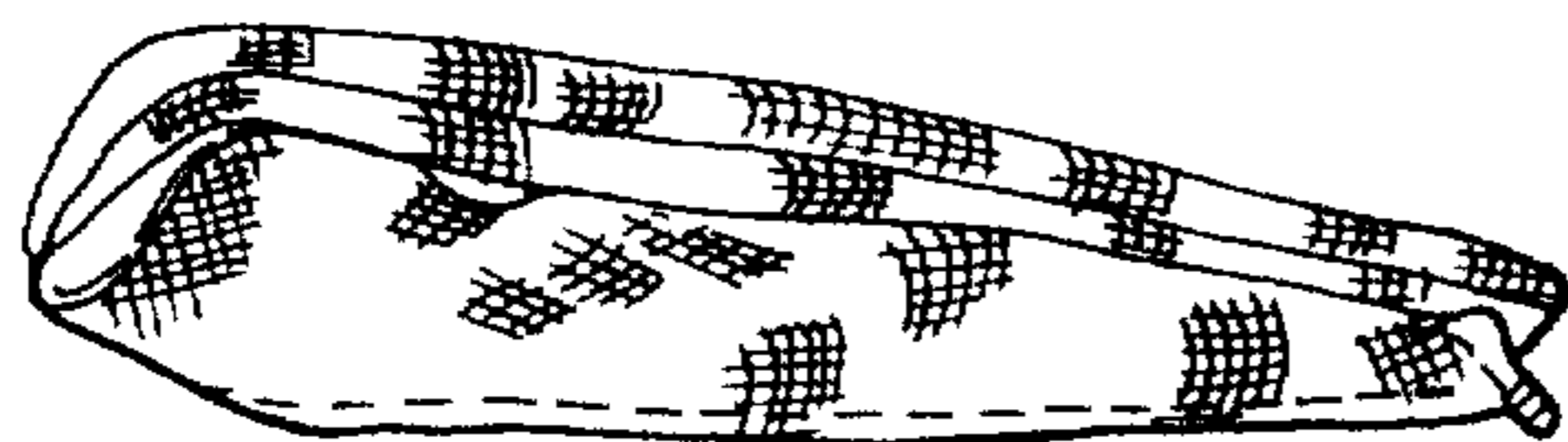

FIG. 5

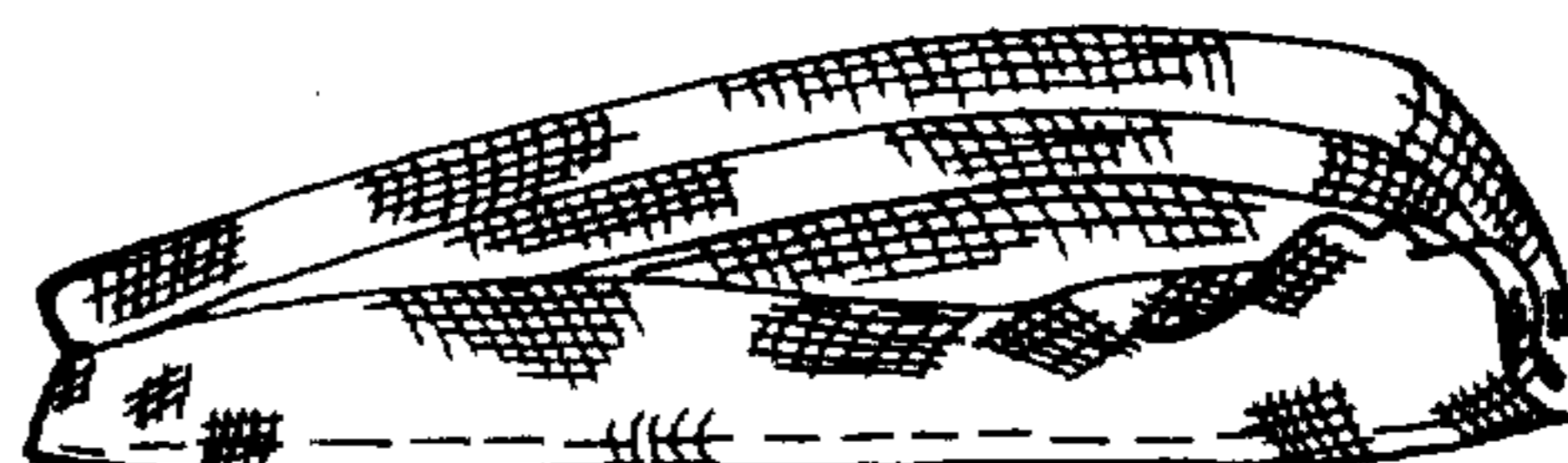

FIG. 6

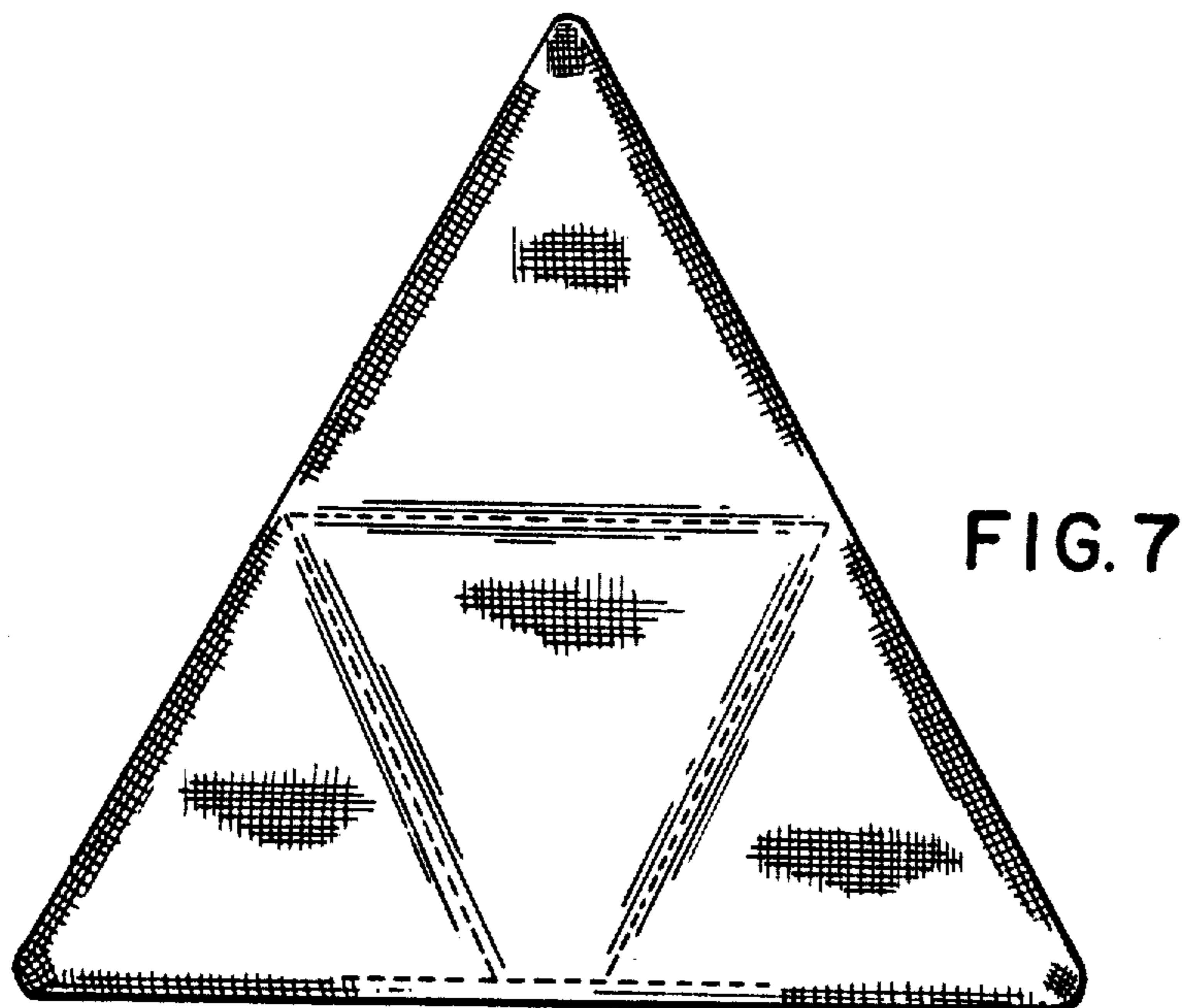

FIG. 8

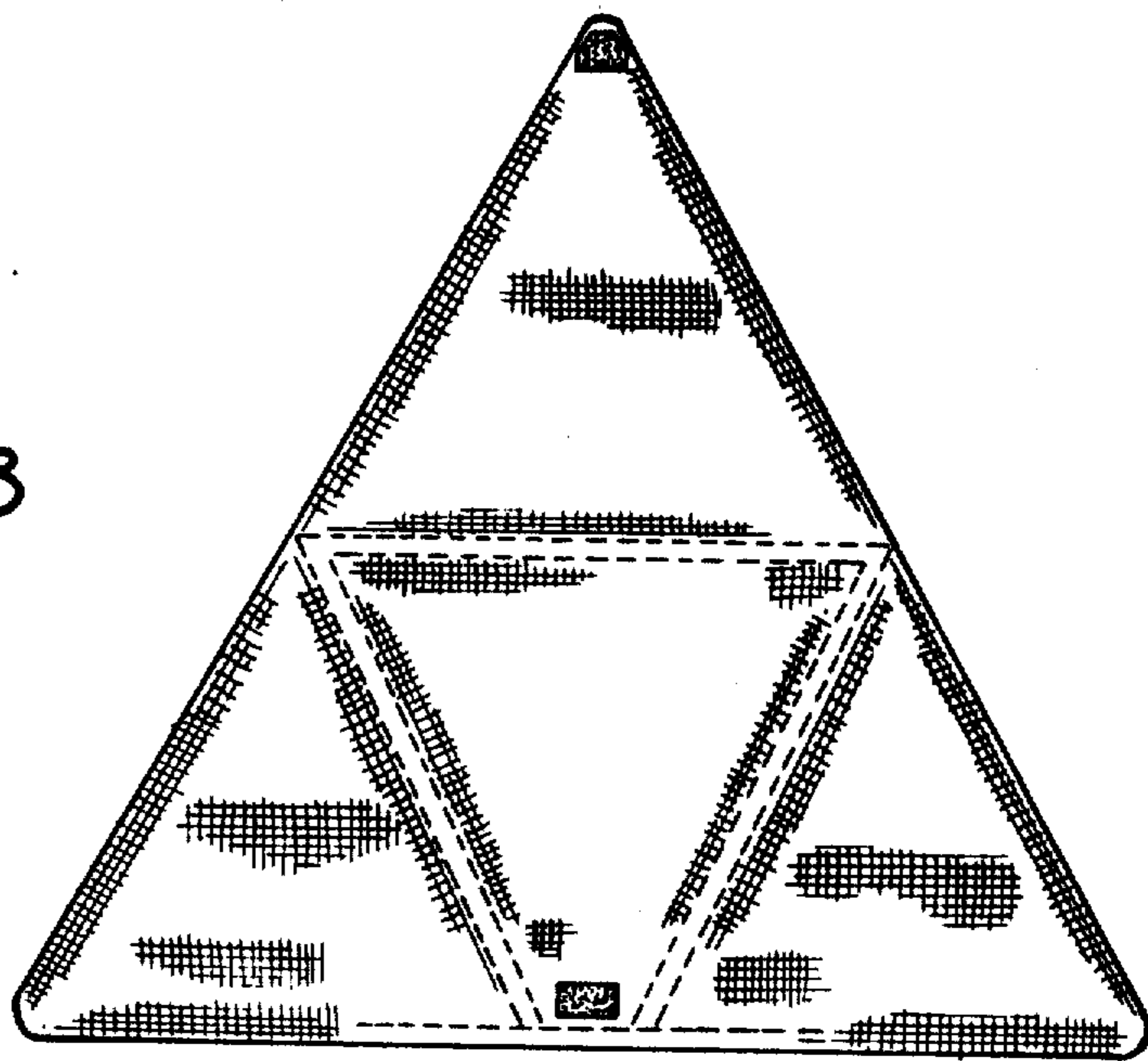

FIG. 9

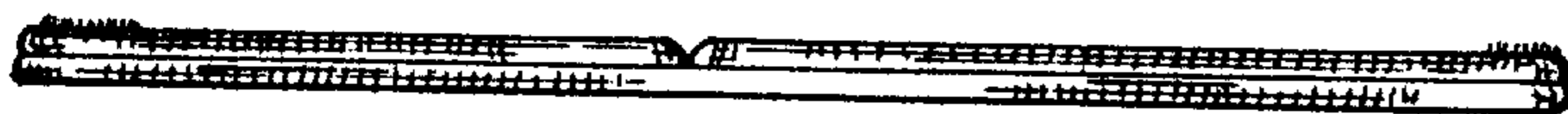

FIG. 10



FIG. 11



FIG.12

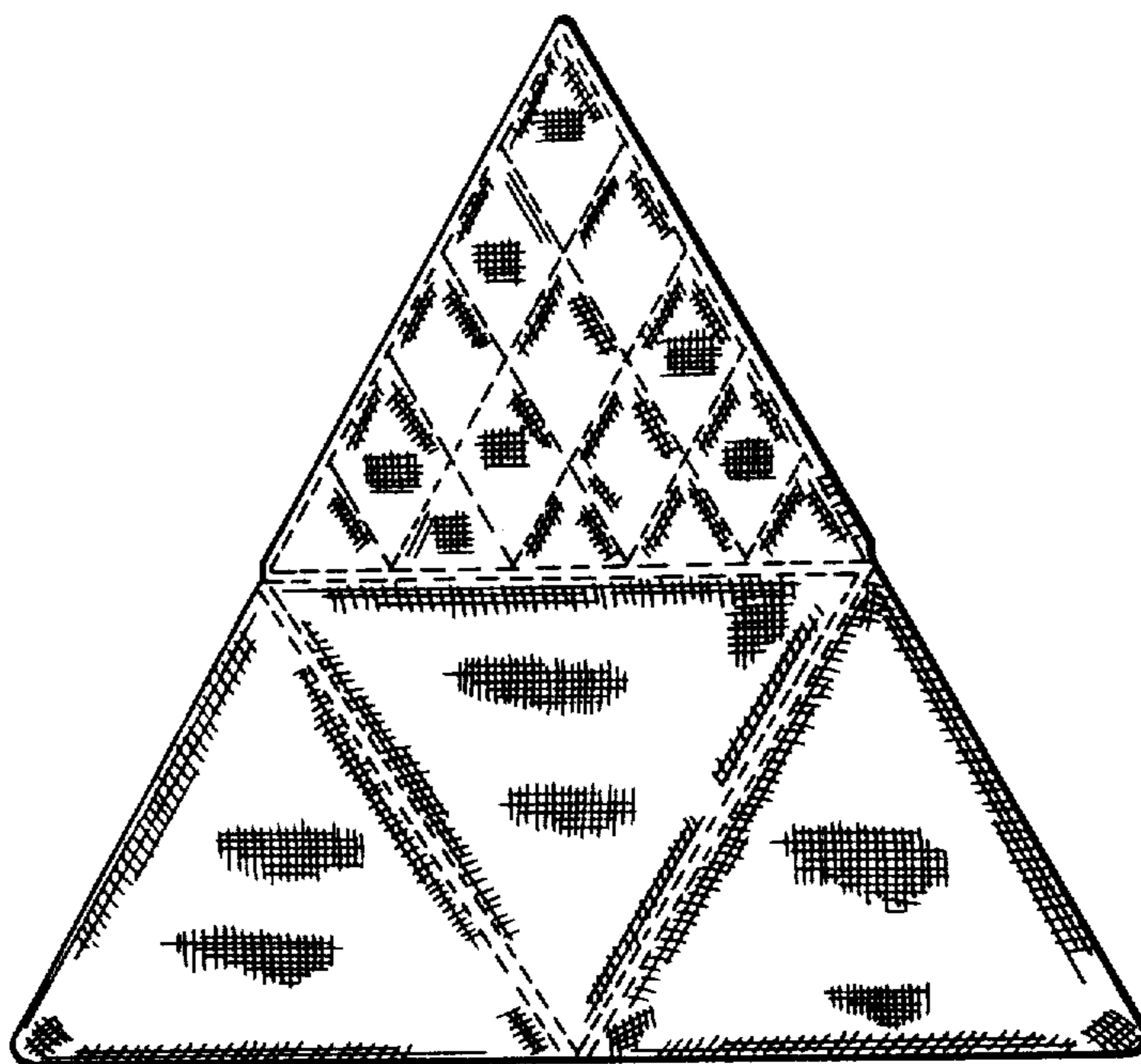

FIG.13

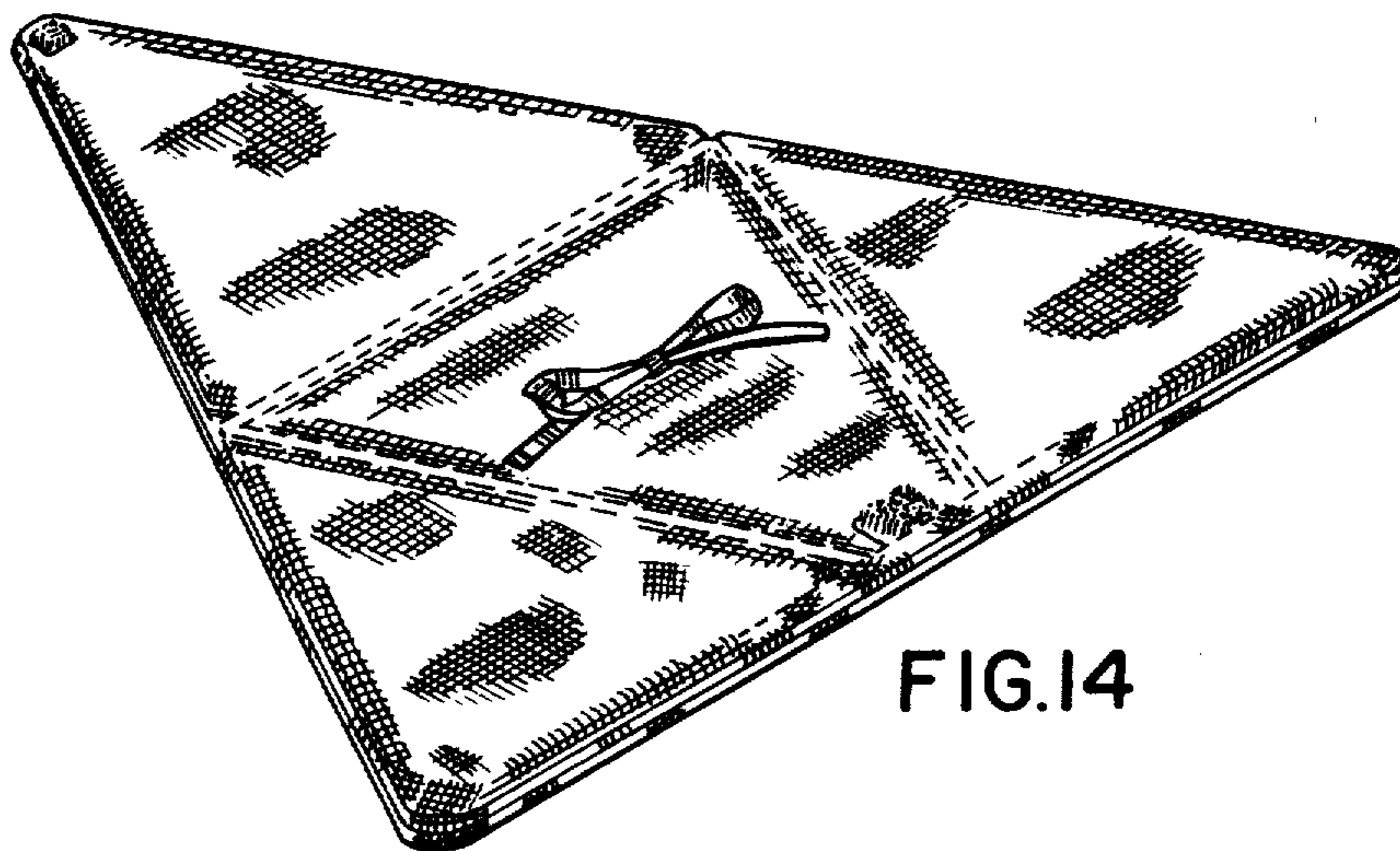

FIG.14